

TCL 10 Pro



T799B

Note:

This is a user manual for TCL 10 Pro T799B.

There may be certain differences between the user manual description and the phone's operation, depending on the software release of your phone or specific carrier services.

Help

Refer to the following resources to get more FAQ, software, and service information.

Finding your serial number or IMEI

You can find your serial number or International Mobile Equipment Identity (IMEI) on the packaging materials. Alternatively, choose **Settings > System > About phone > Status > IMEI information** on the phone itself.

Obtaining warranty service

For information on warranty of your device, visit the USA and Canada websites at <https://www.tclcanada.com/ca/mobile/warranty>

Viewing legal information

On the phone, go to **Settings > System > About phone > Legal information**.

Table of Contents

Safety and use	6
Radio waves	10
Licences	15
General information	18
1 Your mobile	20
1.1 Keys and connectors	20
1.2 Getting started	23
1.3 Home screen	25
2 Text input	34
2.1 Using the Onscreen Keyboard	34
2.2 Text editing.....	35
3 Call, Call log and Contacts	37
3.1 Phone.....	37
3.2 Call log.....	42
3.3 Contacts.....	43
4 Messages	47
4.1 Writing a new message	47
5 Calendar, Clock, and Calculator	50
5.1 Calendar	50
5.2 Clock	51
5.3 Calculator.....	54
6 Getting connected	55
6.1 Connecting to the Internet	55
6.2 Connecting to a Bluetooth device.....	57

6.3	Connecting to a computer via USB	58
6.4	Sharing your phone's cellular data connection.....	59
6.5	Connecting to virtual private networks.....	60
7	Multimedia applications	62
7.1	Camera	62
7.2	Gallery.....	66
8	Others.....	68
8.1	Radio.....	68
8.2	IR Remote.....	69
8.3	Support Center	70
8.4	Other applications	70
9	Google applications.....	71
9.1	Chrome	71
9.2	Gmail.....	71
9.3	Maps	72
9.4	YouTube.....	72
9.5	Drive.....	72
9.6	Play Store	72
9.7	Duo	73
9.8	Photos.....	73
9.9	Keep notes.....	73
9.10	Google Assistant.....	73
9.11	Files	74
10	Settings	75
10.1	Networks & internet	75
10.2	Bluetooth & device connection	77
10.3	Display	78
10.4	NXTVISION.....	80

10.5	Home screen & wallpapers.....	81
10.6	Sound.....	81
10.7	Advanced features.....	82
10.8	Smart Manager	85
10.9	Security	85
10.10	Location	86
10.11	Privacy	87
10.12	Apps.....	87
10.13	Storage	87
10.14	Account.....	87
10.15	Digital Wellbeing & parental controls.....	88
10.16	Google	88
10.17	Accessibility	88
10.18	System.....	88
11	Making the most of your phone	91
11.1	FOTA upgrade.....	91
12	Accessories	92
13	1 YEAR LIMITED WARRANTY	93
14	Electronic Information.....	94
15	Troubleshooting	95
16	Specifications.....	101



www.sar-tick.com

This product meets applicable national SAR limits of 1.6 W/kg. The specific maximum SAR values can be found in the **Radio waves** section.

When carrying the product or using it while worn on your body, either use an approved accessory such as a holster or otherwise maintain a distance of 15 mm from the body to ensure compliance with RF exposure requirements. Note that the product may be transmitting even if you are not making a phone call.



PROTECT YOUR HEARING

To prevent possible hearing damage, do not listen at high volume levels for long periods. Exercise caution when holding your phone near your ear while the loudspeaker is in use.



PROTECT YOUR EYE

TCL 10 Pro received TÜV Rheinland Low Blue Light certification. The display protects against harmful blue light exposure, guarding your eyes during long-duration viewing.

For more information, please visit <http://www.tcl.com/global/en/mobile/tcl10-pro/display.html>

Safety and use

We recommend that you read this chapter carefully before using your phone. The manufacturer disclaims any liability for damage, which may result as a consequence of improper use or use contrary to the instructions contained herein.

TRAFFIC SAFETY:

Given that studies show that using a phone while driving a vehicle constitutes a real risk, even when the hands-free kit is used (car kit, headset...), drivers are requested to refrain from using their phone when the vehicle is not parked. Check the laws and regulations on the use of wireless phones and their accessories in the areas where you drive. Always obey them. The use of these devices may be prohibited or restricted in certain areas.

CONDITIONS OF USE:

- You are advised to switch off the phone from time to time to optimize its performance;
- Remember to abide by local authority rules of mobile phone use on aircrafts;
- If your phone is a unibody device, where the back cover and battery are not removable, disassembling the phone will void your warranty. Disassembling the phone can cause bodily injury if the battery is punctured;
- Always handle your phone with care and keep it in a clean and dust-free place;

- Do not allow your phone to be exposed to adverse weather or environmental conditions, such as moisture, humidity, rain, infiltration of liquids, dust, sea air, etc. The manufacturer's recommended operating temperature range is 0°C (32°F) to 55°C (131°F). At over 55°C (131°F), the legibility of the phone's display may be temporarily impaired;
- Do not open, dismantle, or attempt to repair your phone yourself;
- Do not drop, throw, or bend your phone;
- Use only batteries, battery chargers, and accessories which are recommended by TCL Communication Ltd. and its affiliates and are compatible with your phone model. TCL Communication Ltd. and its affiliates disclaim any liability for damage caused by the use of other chargers or batteries;
- Your phone should not be disposed of in a municipal waste. Please check local regulations for disposal of electronic products;
- Remember to make backup copies or keep a written record of all important information stored on your phone;
- Some people may suffer epileptic seizures or blackouts when exposed to flashing lights, or when playing video games. These seizures or blackouts may occur even if a person never had a previous seizure or blackout. If you have experienced seizures or blackouts, or if you have a family history of such occurrences, please consult your doctor before playing video games on your phone or enabling a flashing-lights feature on your phone;
- Parents should monitor their children's use of video games or other features that incorporate flashing lights on the phones. All persons should discontinue use and consult a doctor if any of the following symptoms occur: convulsion, eye or muscle twitching, loss of awareness, orientation, or movements.

PRIVACY:

Please note that you must respect the laws and regulations in force in your jurisdiction or other jurisdiction(s) where you will use your phone regarding taking photographs and recording sounds with your phone. Pursuant to such laws and regulations, it may be strictly forbidden to take photographs and/or to record the voices of other people or any of their personal attributes, and reproduce or distribute them, as this may be considered to be an invasion of privacy. It is the user's sole responsibility to ensure that prior authorization has been obtained, if necessary, in order to record private or confidential conversations or take a photograph of another person; the manufacturer, the seller or vendor of your phone (including the carrier) disclaim any liability which may result from improper use of the phone.

BATTERY:

Observe the following precautions:

- Do not attempt to open the back cover;
- Do not attempt to eject, replace, or open the battery;
- Do not puncture the back cover of your phone;
- Do not burn or dispose of your phone in household rubbish or store it at temperature above 60°C (140°F);

Phone and battery as a unibody device must be disposed of in accordance with locally applicable environmental regulations.



This symbol on your phone, the battery, and the accessories means that these products must be taken to collection points at the end of their life:

- Municipal waste disposal centers with specific bins for these types of equipment;
- Collection bins at points of sale.

They will then be recycled, preventing substances being disposed of in the environment, so that their components can be reused.

In European Union countries:

These collection points are accessible free of charge.

All products with this sign must be brought to these collection points.

In non-European Union jurisdictions:

Items of equipment with this symbol are not to be thrown into ordinary bins if your jurisdiction or your region has suitable recycling and collection facilities; instead they are to be taken to collection points for them to be recycled.

In the United States you may learn more about CTIA's Recycling Program at <http://www.gowirelessgreen.org/>

CAUTION: RISK OF EXPLOSION IF BATTERY IS REPLACED BY AN INCORRECT TYPE. DISPOSE OF USED BATTERIES ACCORDING TO THE INSTRUCTIONS.

CHARGERS:

Home A.C./ Travel chargers will operate within the temperature range of: 0°C (32°F) to 45°C (113°F).

The chargers designed for your phone meet the standard for safety of information technology equipment and office equipment use. Due to different applicable electrical specifications, a charger you purchased in one jurisdiction may not work in another jurisdiction. They should be used for this purpose only.

Characteristics of power supply:

Travel charger: 9V2A QC3.0

Input: 100-240V, 50/60Hz, 500mA

Output: 5V,3A/9V,2A/12V,1.5A

Battery: Softpack 4500mAh typ

Radio waves.....

THIS PHONE MEETS THE GOVERNMENT'S REQUIREMENTS FOR EXPOSURE TO RADIO WAVES.

Your phone is a radio transmitter and receiver. It is designed and manufactured not to exceed the emission limits for exposure to radio-frequency (RF) energy. These limits are part of comprehensive guidelines and establish permitted levels of RF energy for the general population. The guidelines are based on standards that were developed by independent scientific organizations through periodic and thorough evaluation of scientific studies. These guidelines include a substantial safety margin designed to ensure the safety of all persons, regardless of age and health.

The exposure standard for phones employs a unit of measurement known as the Specific Absorption Rate, or SAR. The SAR limit set by public authorities such as the Federal Communications Commission of the US Government (FCC), or by Innovation, Science and Economic Development Canada (ISED), is 1.6 W/kg averaged over 1 gram of body tissue. Tests for SAR are conducted using standard operating positions with the phone transmitting at its highest certified power level in all tested frequency bands.

This device is complied with SAR for general population /uncontrolled exposure limits in ANSI/IEEE C95.1-1992 and had been tested in accordance with the measurement methods and procedures specified in IEEE1528.

The FCC has granted an Equipment Authorization for this model phone with all reported SAR levels evaluated as in compliance with the FCC RF exposure guidelines. SAR information on this model phone is on file with the FCC and can be found under the Display Grant section of www.fcc.gov/oet/ea/fccid after searching on FCC ID: 2ACCJN034.

Although the SAR is determined at the highest certified power level, the actual SAR level of the phone while operating can be well below the maximum value. This is because the phone is designed to operate at multiple power levels so as to use only the power required to reach the network. In general, the closer you are to a wireless base station antenna, the lower the power output of the phone. Before a phone model is available for sale to the public, compliance with national regulations and standards must be shown.

The highest SAR value for T799B when tested is 1.38 W/Kg for use at the ear and 1.36 W/Kg for use close to the body.

While there may be differences between the SAR levels of various phones and at various positions, they all meet the government requirement for RF exposure.

For body-worn operation, the phone meets FCC RF exposure guidelines provided that it is used with a non-metallic accessory with the handset at least 15 mm from the body.

Use of other accessories may not ensure compliance with FCC RF exposure guidelines.

Additional information on SAR can be found on the Cellular Telecommunications & Internet Association (CTIA) Web site: <http://www.ctia.org/>

The World Health Organization (WHO) considers that present scientific information does not indicate the need for any special precautions for use of phones. If individuals are concerned, they may choose to limit their own or their children's RF exposure by limiting the length of calls, or using "hands-free" devices to keep phones away from the head and body. Additional WHO information about electromagnetic fields and public health are available on the following website: <http://www.who.int/peh-emf>.

Note: This equipment has been tested and found to comply with the limits for a Class B digital device pursuant to part 15 of the FCC Rules. These limits are designed to provide reasonable protection against harmful interference in a residential installation. This equipment generates, uses and can radiate radio frequency energy and, if not installed and used in accordance with the instructions, may cause harmful interference to radio communications. However, there is no guarantee that interference to radio or television reception, which can be determined by turning the equipment off and on, the user is encouraged to try to correct the interference by one or more of the following measures:

- Reorient or relocate the receiving antenna;
- Increase the separation between the equipment and receiver;
- Connect the equipment into an outlet on a circuit different from that to which the receiver is connected;
- Consult the dealer or an experienced radio/ TV technician for help.

Changes or modifications not expressly approved by the party responsible for compliance could void the user's authority to operate the equipment.

For the receiver devices associated with the operation of a licensed radio service (e.g. FM broadcast), they bear the following statement:

This device complies with Part 15 of the FCC Rules and Industry Canada licence-exempt RSS standard(s).

Operation is subject to the following two conditions:

- (1) This device may not cause harmful interference;
- (2) This device must accept any interference received, including interference that may cause undesired operation.

Your phone is equipped with a built-in antenna. For optimal operation, you should avoid touching it or degrading it.

As mobile devices offer a range of functions, they can be used in positions other than against your ear. In such circumstances the device will be compliant with the guidelines when used with a headset or usb data cable.

If you are using another accessory ensure that whatever product is used is free of any metal and that it positions the phone at least 15 mm away from the body.

Please note by using the device some of your personal data may be shared with the main device. It is under your own responsibility to protect your own personal data, not to share with it with any unauthorized devices or third party devices connected to yours. For products with Wi-Fi features, only connect to trusted Wi-Fi networks. Also when using your product as a hotspot (where available), use network security. These precautions will help prevent unauthorized access to your device. Your product can store personal information in various locations including a SIM card, memory card, and built-in memory. Be sure to remove or clear all personal information before you recycle, return, or give away your product. Choose your apps and updates carefully, and install from trusted sources only. Some apps can impact your product's performance and/or have access to private information including account details, call data, location details and network resources.

Note that any data shared with TCL Communication Ltd. is stored in accordance with applicable data protection legislation. For these purposes TCL Communication Ltd. implements and maintains appropriate technical and organizational measures to protect all personal data, for example against unauthorized or unlawful processing and accidental loss or destruction of or damage to such personal data whereby the measures shall provide a level of security that is appropriate having regard to

- The technical possibilities available;
- The costs for implementing the measures;

- The risks involved with the processing of the personal data, and;
- The sensitivity of the personal data processed.

You can access, review, and edit your personal information at any time by logging into your user account, visiting your user profile or by contacting us directly. Should you require us to edit or delete your personal data, we may ask you to provide us with evidence of your identity before we can act on your request.

Innovation, Science and Economic Development Canada (ISED) Notice

This device complies with Innovation, Science and Economic Development Canada license-exempt RSS standard(s). Operation is subject to the following two conditions:

- (1) This device may not cause interference, and
- (2) This device must accept any interference, including interference that may cause undesired operation of the device.

This Class B digital apparatus complies with Canadian ICES-003.

Innovation, Science and Economic Development Canada (ISED) Radiation Exposure Statement

This EUT is compliance with SAR for general population/uncontrolled exposure limits in ISED RSS-102 and had been tested in accordance with the measurement methods and procedures specified in IEEE 1528 and IEC 62209. This equipment should be installed and operated with minimum distance 15 mm between the radiator and your body. This device and its antenna(s) must not be co-located or operating in conjunction with any other antenna or transmitter.

IC: 9238A-0097

Licences



microSD logo is a trademark of SD-3C, LLC.



The Bluetooth word mark and logos are owned by the Bluetooth SIG, Inc. and any use of such marks by TCL Communication Ltd. and its affiliates is under licence. Other trademarks and trade names are those of their respective owners.

TCL T799B Bluetooth Declaration ID D046973



The Wi-Fi Certified Logo is a certification mark of the Wi-Fi Alliance.

Google, the Google logo, Android, the Android logo, Google Search, Google Maps, Gmail, YouTube, Google Play Store, and Hangouts are trademarks of Google Inc.

The Android robot is reproduced or modified from work created and shared by Google and used according to terms described in the Creative Commons 3.0 Attribution License (the text will show when you touch **Google legal** in **Settings > System > About phone > Legal information**) ⁽¹⁾.

You have purchased a product which uses the open source (<http://opensource.org/>) programs mtd, msdosfs, netfilter/iptables and initrd in object code and other open source programs licensed under the GNU General Public Licence and Apache Licence.

You may download the source codes from <https://sourceforge.net/projects/tcl-mobile/files/>. The provision of the source code is free of charge from the internet.

⁽¹⁾ May not be available in all countries.

US Information Concerning the Federal Communications Commission (“FCC”) Requirements for Hearing Aid Compatibility with Wireless Devices

When wireless devices are used near hearing devices (such as hearing aids and cochlear implants), users may detect a buzzing, humming, or whining noise. Some hearing devices are more immune than others to this interference, and wireless devices also vary in the amount of interference that they generate.

The wireless telephone industry has developed ratings to assist hearing device users in finding wireless devices that may be compatible with their hearing devices. Not all wireless devices have been rated. Wireless devices that are rated will have the rating displayed on the box together with other relevant approval markings.

The ratings are not guarantees. Results will vary depending on the user’s hearing device and hearing loss. If your hearing device is vulnerable to interference, you may not be able to use a rated wireless device successfully. Consulting with your hearing health professional and testing the wireless device with your hearing device is the best way to evaluate it for your personal needs.

This smartphone has been tested and rated for use with hearing aids for some of the wireless technologies that the smartphone uses. However, other wireless technologies may be used in this smartphone that have not been tested for use with hearing aids. It is important to try the different features of your smartphone thoroughly and in different locations to determine if you hear any interfering noise when using this smartphone with your hearing aid or cochlear implant. Consult your wireless service provider about its return and exchange policies, and for information about hearing aid compatibility.

Hearing aid compatibility rating for this smartphone: M4/T3.

How the ratings work

M-Ratings: Wireless devices rated M3 or M4 meet FCC requirements and are likely to generate less interference to hearing devices than wireless devices that are not labeled. M4 is the better or higher of the two ratings.

T-Ratings: Wireless devices rated T3 or T4 meet FCC requirements and are likely to be more usable with a hearing device's telecoil ("T Switch" or "Telephone Switch") than unrated wireless devices. T4 is the better or higher of the two ratings. (Note that not all hearing devices have telecoils in them.)

Hearing devices may also be measured for immunity to this type of interference. Your hearing device manufacturer or hearing health professional may help you find results for your hearing device. The more immune your hearing aid is, the less likely you are to experience interference noise from wireless devices.

For more information about the actions that the FCC has taken with regard to hearing aid compatibility with wireless devices and other steps that the FCC has taken to ensure that individuals with disabilities have access to telecommunications services, visit www.fcc.gov/cgb/dro.

FCC ID: 2ACCJN034

General information

- **Website:** www.tclcanada.com/ca/
- **Manufacturer:** TCL Communication Ltd.
- **Address:** 5/F, Building 22E, 22 Science Park East Avenue, Hong Kong Science Park, Shatin, NT, Hong Kong
- **Electronic labeling path:** Touch **Settings > System > Regulatory & safety** or press ***#07#** to find more information about labelling ⁽¹⁾, such as FCC ID.

On our website, you will find our FAQ (Frequently Asked Questions) section. You can also contact us by email to ask any questions you may have.

Your phone is a transceiver that operates on GSM in quad-band (850/900/1800/1900 MHz), UMTS in penta-band (B1/2/4/5/8) or LTE (B1/2/3/4/5/7/8/12/13/17/25/26/28/38/40/41/66).

Protection against theft ⁽²⁾

Your phone is identified by an IMEI (phone serial number) shown on the packaging label and in the phone's memory. We recommend that you note the number the first time you use your phone by entering ***#06#** and keep it in a safe place. It may be requested by the police or your carrier if your phone is stolen. This number allows your phone to be blocked preventing a third person from using it, even with a different SIM card.

⁽¹⁾ This may vary depending on country.

⁽²⁾ Contact your network carrier to check service availability.

Disclaimer

There may be certain differences between the user manual description and the phone's operation, depending on the software release of your phone or specific carrier services.

TCL Communication Ltd. shall not be held legally responsible for such differences, if any, nor for their potential consequences, which responsibility shall be borne by the carrier exclusively.

Frequency Stability

The product meets Section 15.407(g) requirements from KDB 789033 D02v02r01. The emissions are maintained within the band of operation under all conditions of normal operation.

1 Your mobile.....

1.1 Keys and connectors

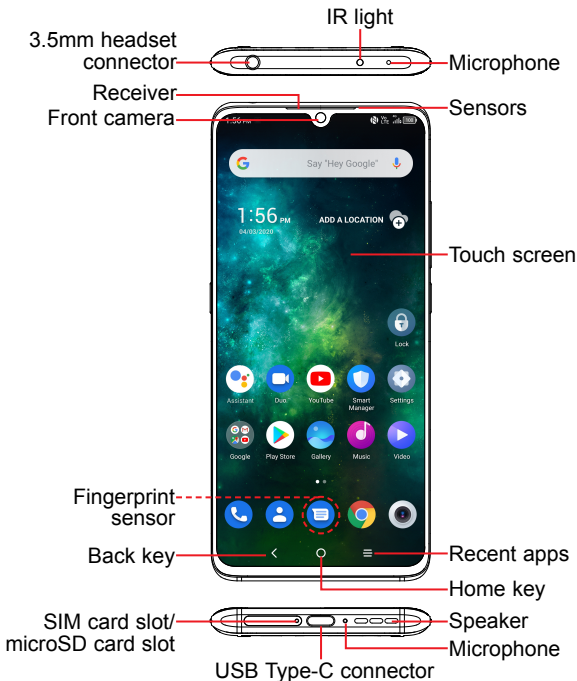

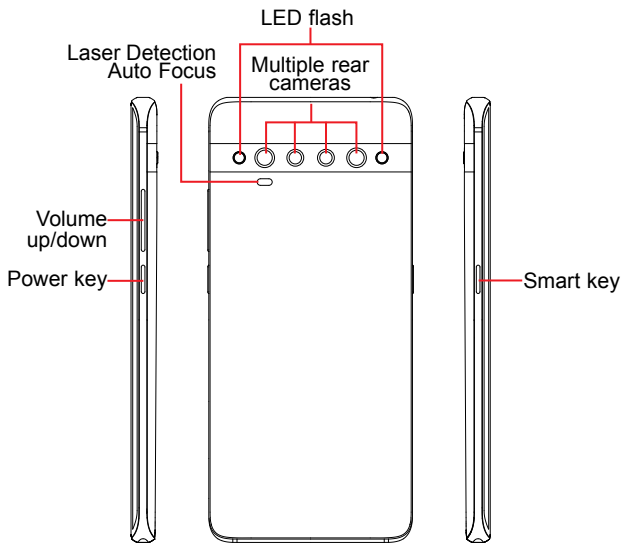

Smart Key⁽¹⁾ (left of the device)

- Smart key settings are available at: **Settings > Advanced features > Smart Key**. Or touch Smart Key in the app list.



Back key

- Touch to go back to the previous screen, or close a dialog box, options menu, the notification panel, etc.

⁽¹⁾ Customized convenient shortcut.



Home key

- Touch to return to the Home screen from any other application or screen.



Recent apps

- Touch to switch between recently opened individual app activities and documents.



Power key (right of the device)

- Press: Lock the screen/Light up the screen.
- Press and hold: Show the popup menu to select from Power off/Restart/Airplane mode.
- Press and hold the **Power** key and **Volume up** key to enter Recovery mode.
- Press and hold the **Power** key and **Volume down** key to take a screenshot.
- Press and hold the **Power** key for at least 10 seconds to force reboot.



Volume keys

- In call mode, adjusts the earpiece or headset volume.
- In Music/Video/Streaming mode, adjusts the media volume.
- In general mode, adjusts the ringtone volume.
- Mutes the ringtone of an incoming call.
- In camera preview mode, press the **Volume up** or **down** key to take a photo or press and hold to take burst shots.
- Press the **Volume up** and **down** keys at the same time for 3 seconds to start an accessibility feature when **Volume key shortcut** is on. To set, touch **Settings > Accessibility > Volume key shortcut**.

1.2 Getting started

1.2.1 Setting up

Inserting or removing the SIM/microSD card

- ① Use the provided SIM pin to open the SIM tray.
- ② Place the Nano SIM card into the tray slot labeled "SIM".
- ③ Place the microSD™ card into the tray slot labeled "SD".

Note: microSD™ cards are sold separately. Only use Nano SIM cards with your phone.

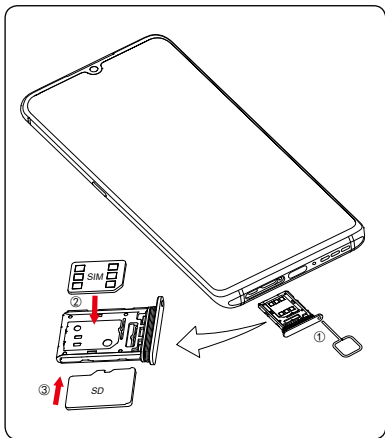



You must insert your SIM card to make phone calls. You do not need to power off your phone before inserting or removing the SIM card as this phone supports hot swap.

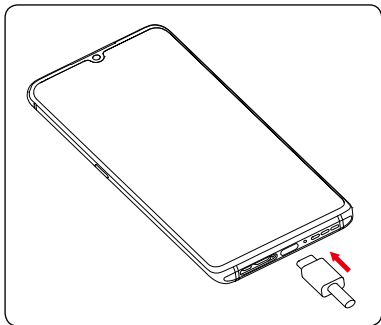

Your phone only supports nano-SIM cards. Do not attempt to insert other SIM types; otherwise this may cause damage to your phone.

Charging the battery



You are advised to fully charge the battery (). Charging status is indicated by a percentage displayed on screen while the phone is powered off. The percentage increases as the phone is charged.



To reduce power consumption and energy waste when the battery is fully charged, disconnect your charger from the plug; switch off Wi-Fi, GPS, Bluetooth or background-running applications when not in use; reduce the backlight time, etc.

1.2.2 Powering on your phone

Hold down the **Power** key until the phone powers on, unlock your phone (Swipe, PIN, Password, Pattern, Fingerprint, or Face) if necessary and confirm. The Home screen is displayed.

If you do not know your PIN code or forget it, contact your network carrier. Be sure to keep your PIN code secure.

1.2.3 Powering off your phone

Press and hold the **Power** key until options appear, then select **Power off**.

1.3 Home screen

You can bring all of the items that you use most frequently (applications, shortcuts, folders) to your Home screen for quick access.

Tapping Home  always takes you back to the main Home screen.

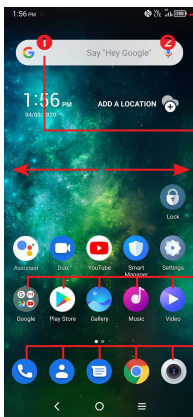

Status bar

- Status/Notification indicators
- Touch and drag down to open the notification panel

Search bar

- Touch **1** to enter text search screen
- Touch **2** to enter voice search screen

Touch an icon to open an application, folder, etc.

Favorite tray applications

- Touch to enter the application
- Touch and hold to move or remove applications

The Home screen is provided in an extended format to allow more space for adding applications, shortcuts etc. Slide the Home screen horizontally left and right to get a complete view.

1.3.1 Using the touchscreen

Touch 

To access an application, touch it with your finger.

Touch and hold 

To enter the available options for an item, touch and hold the item. For example, select a contact in Contacts and touch and hold it. An options list will then appear.

Drag 

Place your finger on the screen to drag an object to another location.

Slide/Swipe 

Slide the screen to scroll up and down the applications, images, and web pages. You can slide the screen horizontally too.

Flick 

Similar to swiping, but flicking makes it move quicker.

Pinch/Spread 

Place two fingers on the screen surface and draw them apart or together to scale an element on the screen.

Rotate



Automatically change the screen orientation from portrait to landscape by turning the phone sideways to have a better screen view.

1.3.2 Status bar

From the status bar, you can view both phone status (on the right side) and notification information (on the left side).

Drag down the status bar to view notifications and drag again to enter the quick settings panel.

Touch and drag up to close it. When there are notifications, they can be accessed by touching them.

Notification panel

When there are notifications, touch and drag down the Status bar to open the Notification panel to read more detailed information.

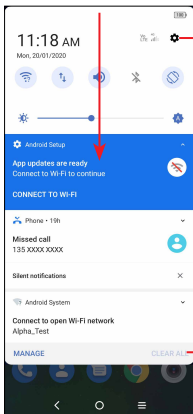

Touch to access **Settings**, where you can set more items.

Touch to clear all event-based notifications (other ongoing notifications will remain).

Quick settings panel

Touch and drag down from the top of the screen once using two fingers, or twice using one finger to open the Quick settings panel.

You can enable or disable functions or change modes by touching the icons, e.g. Wi-Fi, Bluetooth etc.

Touch the **Edit** icon  to customize your Quick settings panel.

Touch to turn on/off items, e.g. Wi-Fi, Bluetooth etc.

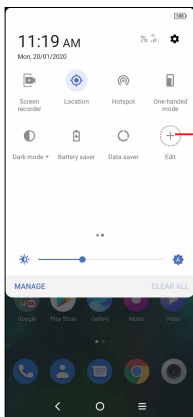
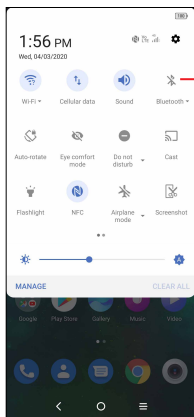

Touch to customize your Quick settings panel.

1.3.3 Lock/Unlock your screen

To protect your phone and privacy, you can lock the screen with a pattern, PIN, password, fingerprint, or face.

To create a screen unlock pattern, touch **Settings > Security > Screen lock**.

To lock phone screen

- If your phone remains inactive for a period of time, it will automatically lock the screen and enter sleep mode to save power. Go to **Settings > Display > Sleep** and select a screen timeout period.
- You can also manually lock the screen by pressing the **Power** key once.

To unlock the phone screen

Press the **Power** key once to light up the screen, swipe up and unlock the screen with the method you have set.

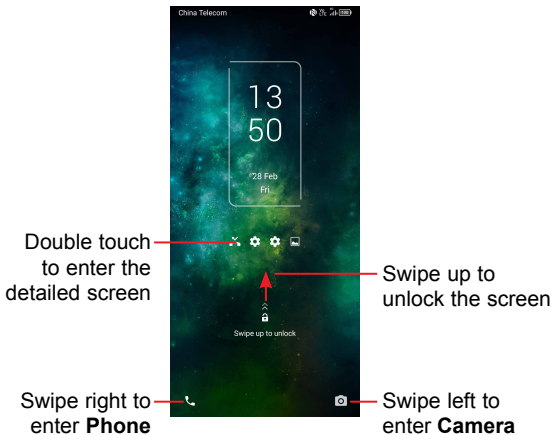

Enter a password to unlock the screen

Once the screen is turned on, swipe up from any position on the screen to display the password input panel. Then enter your lock screen password.

Use pattern unlock

Draw the same pattern you have set to unlock the screen.

Use Face unlock

- From the app list, touch **Settings** > **Security** > **Face key**. Before using the face key, you need to set a pattern/PIN/password.

- Hold your phone 20-50 cm from your face. Position your face in the square shown on the screen. For best results, we suggest that the face key is enrolled indoors and away from direct sunlight.
- Enable Face unlock when screen turns on, or you have to swipe first before.

Use Fingerprint unlock

Once the screen is turned on, the fingerprint icon will display on the screen. Touch the fingerprint sensor with an enrolled finger to unlock the screen.

1.3.4 Personalizing your Home screen

Add

You can touch and hold a folder, an application or a widget and drag the item to your preferred Home screen.

Reposition

Touch and hold an item and drag it to the desired position and then release. You can move items both on the Home screen and the Favorite tray. Hold the icon on the left or right edge of the screen to drag the item to another Home screen.

Remove

Touch and hold the item and drag it up to the top of the  remove icon, and release after it turns red.

Create folders

To improve the organization of shortcuts or applications on the Home screen and the Favorite tray, you can add them to a folder by stacking one item on top of another. To rename a folder, open it and touch the folder's title bar to input the new name.

Wallpaper customization

Touch and hold an empty area on the Home screen, then touch **Wallpapers** to customize wallpaper.

1.3.5 Widgets and recently used applications

Consult widgets

Touch and hold the empty area in the Home screen, then touch **Widgets** to display all widgets.

Touch the selected widget and slide it to move to your preferred screen.

Consult recently used applications

To consult recently used applications, touch the **Recent apps** key. Touch a thumbnail in the window to open the application.

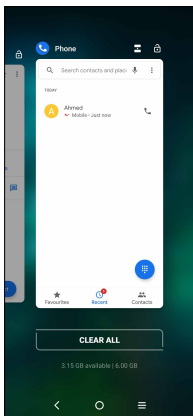

Touch one thumbnail and slide it up to close the application, slide it right/left to switch the applications.

Touch **Clear all** at the bottom of the screen to close all the running applications.

1.3.6 Volume adjustment

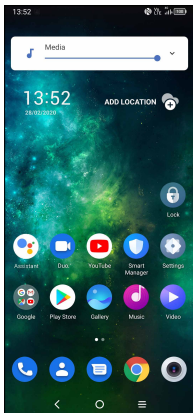

Press the **Volume** key to adjust the Media volume.

Touch the **▼** icon to adjust Alarm, Ring and Notification volume.

2 Text input

2.1 Using the Onscreen Keyboard

Onscreen Keyboard settings

Touch **Settings > System > Language & input**, touch the Virtual keyboard you want to set up and a series of settings will become available.

Adjust the Onscreen Keyboard orientation

Turn the phone sideways or upright to adjust the onscreen keyboard orientation. You can adjust it by changing the settings (Touch on/off **Settings > Display > Auto-rotate screen**).

2.1.1 Android keyboard

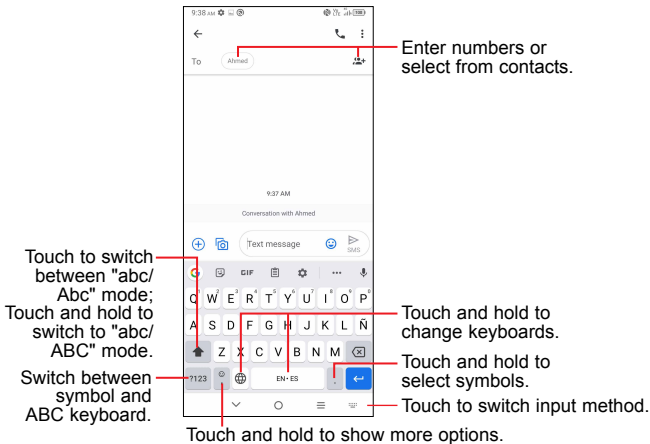

2.2 Text editing

You can edit text which you have entered.

- Touch and hold or double touch within the text you want to edit.
- Drag the tabs to change the amount of text to edit.
- The following options will appear: **Cut**, **Copy**, **Share**, and **Select all**.

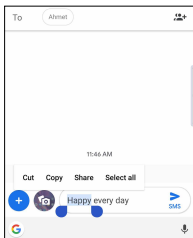

You can also insert new texts if preferred

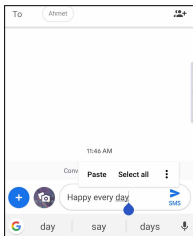

- Touch where you want to type, or touch and hold a blank area. The cursor will blink and the tab will appear. Drag the tab to move the cursor.
- If you have cut or copied any text, touch the tab to show the **Paste** option which allows you to complete pasting immediately.



3 Call, Call log and Contacts .

3.1 Phone

3.1.1 Making a call

From the Phone  app, use the keypad to enter the phone number, or keyboard to enter the contact name. Then tap  to place the call.

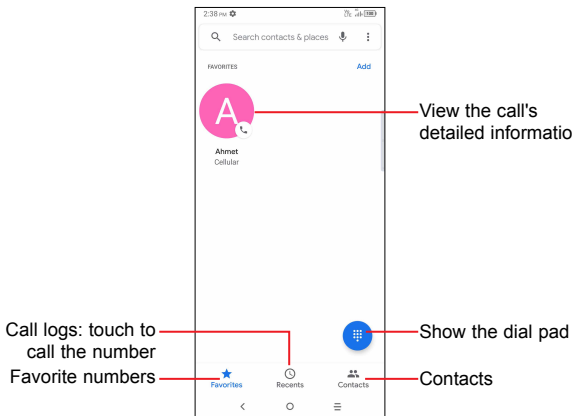

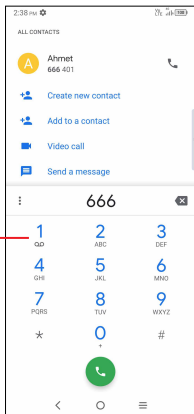

Touch and hold to
access voicemail





Enter the desired number from the dial pad and touch  to place the call or select a contact from **Favorites**, **Recents**, or **Contacts** by sliding or touching tabs, then make the call.

The number you entered can be saved to **Contacts** by touching **Create new contact** or **Add to a contact**.

If you make a mistake, you can delete the incorrect digits by touching .

To hang up a call, touch .

International call

To dial an international call, touch and hold  to enter "+", then enter the international country prefix followed by the full phone number and touch .



Emergency call

If your phone has network coverage, dial the emergency number and touch  to make an emergency call. Depending on your network and country this could even work without a SIM card and without typing in the SIM PIN code.

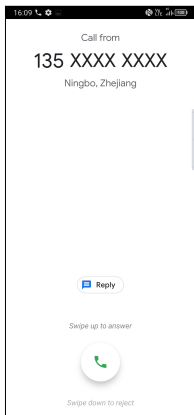
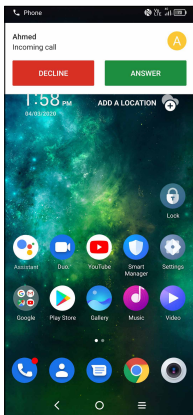
3.1.2 Answering or rejecting a call





When you receive a call:

- Tap **ANSWER**, or swipe up the icon  to answer;
- Tap **DECLINE**, or swipe down the icon  to reject;
- Tap  to reject the call by sending a preset message.

3.1.3 Calling your voicemail

Your voicemail is provided by your network to avoid missing calls. It works like an answering machine that you can consult at any time.

To access your voicemail, touch and hold .

If you receive a voicemail,  appears on the Status bar. Open the Notification panel and touch **New voicemail**.

3.1.4 During a call

To adjust the volume during a call, press the **Volume up/down** key.

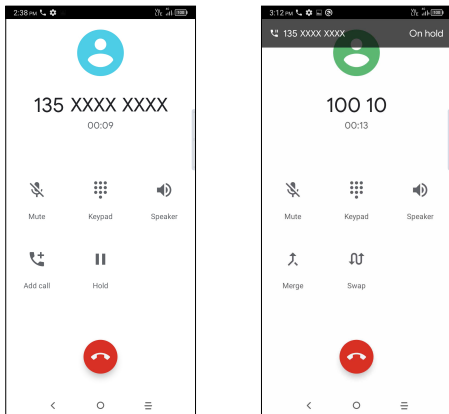



End the current call.



Touch to mute the current call. Touch this icon again to unmute the call.



Display the dial pad.



Touch to activate the speaker during the current call. Touch this icon again to deactivate the speaker.



Make another call.



Put a call on hold.



Merge calls to start a conference call.



Split a conference call into multiple calls.



Swap the calls.



To avoid accidental operation of the touchscreen during a call, the screen will be locked automatically when you put the cellphone close to your ear; and it will be unlocked when the cellphone is taken away from your ear.

3.1.5 Managing multiple calls





With this phone you can handle multiple calls at the same time.

Swap calls

When you accept two calls, touch the  icon to switch between two lines. The current call will be put on hold and you are able to join the other call.

Conference calls⁽¹⁾

You can set up a conference call as follows.

- Place a call to the first participant of the conference call.
- Touch  to add another call.
- Enter the phone number of the person you want to add to the conference and touch . You can also add participants from **Call logs** or **Contacts**.
- Touch  to start the conference.
- Touch  to end the conference call and disconnect all callers.

3.1.6 Call settings

Touch  from the **Phone** screen, then touch **Settings** to set phone and contact settings.

3.2 Call log

You can access your call logs by touching  from the **Phone** screen to view missed calls, outgoing calls, and incoming calls.

Touch one call to view information or further operations. You can launch a new call, send a message to the contact or number, or view detailed information of the call.

To delete the call history of selected contact or number, touch and hold the contact and choose **Delete**.

⁽¹⁾ Depending on your network carrier.

3.3 Contacts



Contacts enables quick and easy access to the contact you want to reach.

Use **Contacts** to view your saved contacts or create a new contact. Synchronize your contacts from your email account(s) and other applications to your phone.

3.3.1 Consult your Contacts

To see your contacts, touch  from the App drawer.

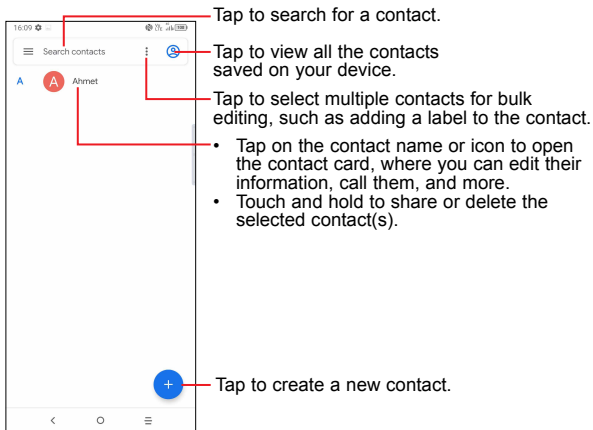

Deleted contacts will also be removed from other applications on the phone or web the next time you synchronize your phone.

3.3.2 Adding a contact

Touch  in the contact list to create a new contact.

You are required to enter the contact's name and other contact information. By scrolling up and down the screen, you can move from one field to another.

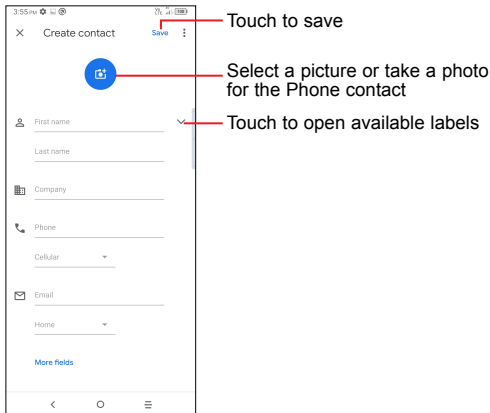

Add to/remove from Favorites ⁽¹⁾

To add a contact to favorites, you can touch a contact to view details then touch  to add the contact to favorites.

To remove a contact from favorites, touch  on the contact details screen.

⁽¹⁾ Only phone contacts can be added to favorites.

3.3.3 Editing your contacts



To edit contact information, touch  in the contact details screen.

When finished, touch **Save**.

3.3.4 Using the Quick contact panel

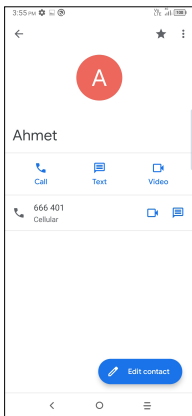
Touch a contact to open the Quick contact panel.



- Touch  or the number to make a call.
- Touch  to send a message.
- Touch  to make a video call ⁽¹⁾.

The icons available on the Quick contact panel depend on the information you have for the contact and the applications and accounts on your phone.

⁽¹⁾ Depending on your network carrier.

3.3.5 Sharing contacts

You can share a single contact or contacts with others by sending the contact's vCard to them via Bluetooth, Gmail, etc.

- From the Contacts screen, touch and hold a contact and touch .
- Select the application to perform this action.

3.3.6 Accounts

Contacts, data or other information can be synchronized from multiple accounts, depending on the applications installed on your phone.

To add an account, touch  from the contacts list and touch **Settings > Accounts > Add account**, or from the home screen, touch **Settings > Accounts > Add account**.

You are required to select the kind of account you are adding, like Google, etc.

As with any other account setup, you need to enter detailed information, like username, password, etc.

You can remove an account and all associated information from the phone. Touch the account you want to delete, touch **Remove account**, then confirm.

Auto-sync

On the **Accounts** screen, turn on **Automatically sync data** . When activated, all changes to information on the phone or online will be automatically synchronized with each other.

4 Messages



4.1 Writing a new message



You can create, edit, send, and receive SMS and MMS with this phone.

To access Messages, touch  from the App drawer.

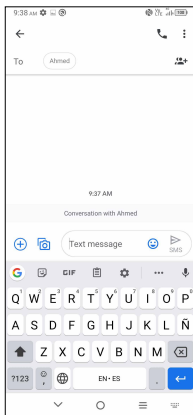
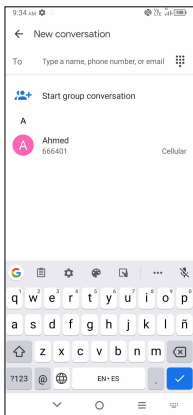
On the message list screen, touch  to write text/multimedia messages.



Sending a text message

- To add recipients, enter a mobile phone number or select a contact in the **To** bar.
- After entering a mobile phone number, tap **Send to XXX**.
- In the **Text message** bar, enter the text of the message.
- Touch  to insert emoticons, location, voice memo, or other file.
- When finished, touch  to send the text message.





Specific letters (accented) will also increase the size of the SMS. This may cause multiple SMS to be sent to your recipient.

Sending a multimedia message

MMS enables you to send video clips, images, photos, animations, slides, and sounds to other compatible mobiles and e-mail addresses.

An SMS will be converted to MMS automatically when media files (image, video, audio, slides, etc.) are attached or subject or email addresses are added.

- To send a multimedia message, enter the recipient's phone number in the **To** bar.
- In **Text message** bar to enter the text of the message.
- Touch  to attach a picture, video, audio, etc.
- When finished, touch  to send the multimedia message.

4.1.1 Manage messages

When receiving a message,  will appear on the Status bar as a notification. Drag down the Status bar to open the Notification panel. Touch the new message to open and read it. You can also access the **Messages** application and touch the message to open it.

Messages are displayed as a conversation.

Touch a message to enter the message composing screen:

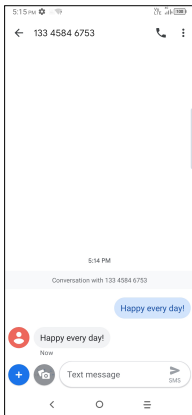

Touch  to call the number;

To adjust message settings, touch  and select **Settings** on the message list screen.

5 Calendar, Clock, and Calculator

5.1 Calendar



Use **Calendar** to keep track of important meetings, appointments, etc.



To view the calendar and create events, touch  from the app drawer.

5.1.1 Multimode view



You can display the Calendar by **Schedule**, **Day**, **3 days**, **Week**, or **Month**, touch  to select.

5.1.2 To create new events

You can add new events from any Calendar view.

- Touch  .
- Fill in all required information for this new event. If it is a whole-day event, you can turn on **All-day**  .
- Invite guests to the event. Enter the email addresses of the guests you want to invite with commas to separate. The guests will receive an invitation from Calendar and Email.
- When finished, touch **Save** from the top of the screen.

5.1.3 To delete or edit an event

To delete or edit an event, touch the event to enter its details screen. Touch  to edit the event, or touch  > **Delete** to delete.

5.1.4 Event reminder

If a reminder is set for an event, the upcoming event icon  will appear on the Status bar as a notification when the reminder time arrives.

Touch and drag down the Status bar to open the notification panel, touch an event name to view the Calendar notification list. Touch the **Back** key to keep the reminders pending in the Status bar and the notification panel.

5.2 Clock







Your mobile phone has a built-in clock.

To view the current time, touch  from the app drawer.

5.2.1 Alarm

From the Clock screen, touch **Alarm** to enter.

- Turn on  to enable the alarm.
- Touch  to add a new alarm, touch  to save.
- Touch a currently existing alarm to enter the alarm editing screen.
- Touch  to delete the selected alarm.

5.2.2 Clock



To view the date and time, touch **Clock**.

- Touch  to choose a city.

5.2.3 Timer

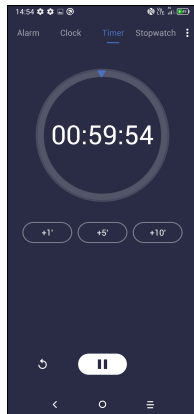
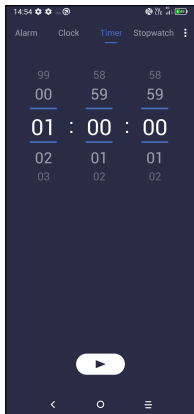
From the Clock screen, touch **Timer** to enter.





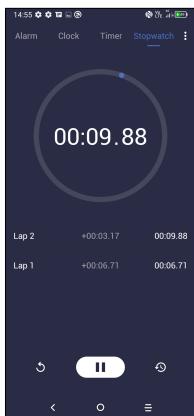
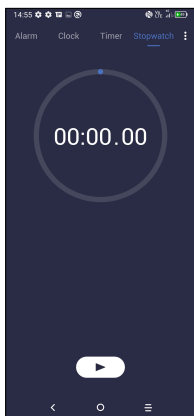

- Set the time.
- Touch  to start the countdown.
- Touch  to pause.
- Touch  to reset.

5.2.4 Stopwatch

From the Clock screen, touch **Stopwatch** to enter.



- Touch  to start the Stopwatch.
- Touch  to show a list of records according to the updated time.
- Touch  to pause.
- Touch  to reset.
- Touch  to share.

5.2.5 Adjust Clock settings

Touch  to access Clock and Alarms settings.

5.3 Calculator.....



There are two panels available: Basic panel and Advanced panel.

Touch  to switch between panels, select one of the following two ways:

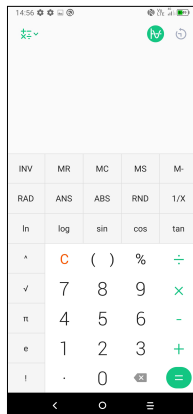
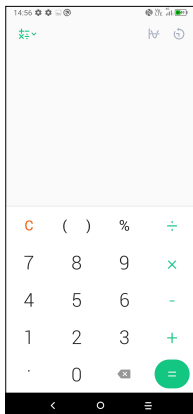

Touch  to delete digits one by one.

6 Getting connected

To connect to the internet with this phone, you can use 2G/3G/4G networks or Wi-Fi, whichever is most convenient.

6.1 Connecting to the Internet

6.1.1 2G/3G/4G

The first time you turn on your phone with your SIM card inserted, it will automatically configure your network service: 2G, 3G or 4G.

If the network is not connected, you can turn on cellular data in **Settings > Network & internet > Data usage > Cellular data**.

To check the network connection you are using, touch **Settings > Network & internet > Cellular network > Access Point Names** or **Network**.

To create a new access point

A new 2G/3G/4G network connection can be added to your phone with the following steps:

- Touch **Settings > Network & internet > Cellular network > Access Point Names**.
- Touch **+** and enter the required APN information.
- When finished, touch **⋮ > Save**.

To enable data roaming

- Touch **Settings > Network & internet > Cellular network > Data roaming**.
- Turn on  .
- When data roaming is disabled, you can still perform data exchange with a Wi-Fi connection (refer to “6.1.2 Wi-Fi”).

To set preferred network mode

- Touch **Settings > Network & internet > Cellular network > Preferred network type**.

6.1.2 Wi-Fi

You can connect to the internet when your phone is within range of a wireless network. Wi-Fi can be used on your phone even without a SIM card inserted.

To turn Wi-Fi on and connect to a wireless network

- Touch **Settings > Network & internet > Wi-Fi**.
- Turn on  .
- Once Wi-Fi is turned on, detected Wi-Fi networks are listed.
- Touch a Wi-Fi network to connect to it. If the network you selected is secured, you are required to enter a password or other credentials (you may need to contact the network carrier for details). When finished, touch **CONNECT**.

To add a Wi-Fi network

When Wi-Fi is on, you may add new Wi-Fi networks according to your preference.

- Touch **Settings > Network & internet > Wi-Fi > Add network**.

- Enter the name of the network and any required network information.
- Touch **SAVE**.

To forget a Wi-Fi network

The following steps prevent automatic connections to networks which you no longer wish to use.

- Turn on Wi-Fi, if it's not already on.
- On the Wi-Fi screen, touch and hold the name of the saved network.
- Touch **Forget network** in the dialog that opens.

6.2 Connecting to a Bluetooth device

Bluetooth is a short-range wireless communication technology that you can use to exchange data, or connect to other Bluetooth devices for various uses.

To turn on Bluetooth

- Touch **Settings > Bluetooth & device connection > Bluetooth**.
- Turn on  .

Your device name and other available devices will appear on screen.

To rename your device

- Touch **Settings > Bluetooth & device connection > Bluetooth > Device name**.
- Enter a name, and touch **RENAME** to confirm.

To pair/connect your phone with a Bluetooth device

To exchange data with another device, you need to turn Bluetooth on and pair your phone with the Bluetooth device with which you want to exchange data.

- Touch **Settings > Bluetooth & device connection > Bluetooth > Pair new device**.
- Touch a Bluetooth device you want to pair your phone with in the list.
- A dialog will pop up, touch **PAIR** to confirm.
- If the pairing is successful, your phone connects to the device.

To unpair from a Bluetooth device

- Touch  beside the device you want to unpair.
- Touch **FORGET** to confirm.

Super Bluetooth

Your device can connect with up to 4 audio devices ⁽¹⁾ simultaneously and once connected, it can calibrate each one to provide a richer listening experience.

6.3 Connecting to a computer via USB

With the USB cable, you can transfer media files and other files between your phone and computer.

⁽¹⁾ Will decrease to 2 audio devices when connected to Wi-Fi 2.4GHz network.

To connect your phone to the computer

Use the USB cable that came with your phone to connect the phone to a USB port on your computer. You will receive a notification that the USB is connected.

Open the Notification panel and touch **Android system**, then, in the next dialogue, choose the way in which you want to transfer files. By default, **Charge this device** is selected.



Before using MTP (Media Transfer Protocol), make sure that the driver (Windows Media Player 11 or higher version) has been installed.

6.4 Sharing your phone's cellular data connection

You can share your phone's cellular data connection with a single computer via a USB cable (USB tethering) with Bluetooth (Bluetooth tethering) or up to eight devices at once via Wi-Fi (mobile hotspot).



The functions below may incur additional network charges from your network carrier. Extra fees may also be charged in roaming areas.

To share your phone's data connection via USB and Bluetooth, or as a mobile hotspot

- Go to **Settings > Network & internet > Hotspot & tethering** to activate these functions.

To rename or secure your mobile hotspot

- Go to **Settings > Network & internet > Hotspot & tethering > Mobile hotspot** to activate.

When mobile hotspot is activated, you can rename your phone's Wi-Fi network (SSID) and secure its Wi-Fi network.

- Touch **Settings > Network & internet > Hotspot & tethering > Mobile hotspot**.
- Touch **Set up mobile hotspot** to rename the network SSID or set your network security.
- Touch **SAVE**.

6.5 Connecting to virtual private networks

Virtual private networks (VPNs) allow you to connect to the resources inside a secured local network from outside that network. VPNs are commonly deployed by corporations, schools, and other institutions so that their users can access local network resources when not inside that network, or when connected to a wireless network.

To add a VPN

- Touch **Settings > Network & internet > VPN** and then touch .
- On the screen that opens, follow your network administrator's instructions to configure each component of the VPN settings.
- Touch **SAVE**.

The VPN is added to the list on the VPN settings screen.



Before adding a VPN, you should set a screen lock for your phone.

To connect/disconnect to/from VPN

To connect to a VPN:

- Touch **Settings > Network & internet > VPN**.
- The VPNs you have added are listed. Touch the VPN you want to connect with.

- In the dialog that opens, enter any requested credentials and touch **CONNECT**.

To disconnect from a VPN:

- Touch the VPM you want to disconnect from. In the dialog that opens, touch **DISCONNECT**.

To edit/delete a VPN

To edit a VPN:

- Touch **Settings > Network & internet > VPN**.
- The VPNs you have added are listed. Touch  beside the VPN you want to edit.
- After editing, touch **SAVE**.

To delete a VPN:

- Touch  beside the VPN you want to delete, then touch **FORGET** to delete it.

7 Multimedia applications

7.1 Camera





Your mobile phone is fitted with a camera for taking photos and videos.

Before using the camera, make sure that you remove the protective lens cover to avoid it affecting your picture quality.

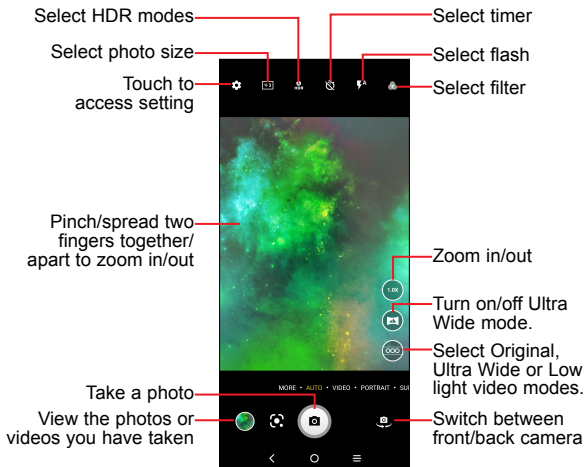

To take a photo or video, touch  from the app drawer.



To take a photo



The screen acts as the viewfinder. First, position the object or landscape in the viewfinder, touch the screen to focus if necessary. Touch  to capture. The photo will be automatically saved. You can also touch and hold  to take burst shots, the maximum number is 20.

To take a video

Touch **VIDEO** to change the camera mode to video. Touch  to start video recording. Touch the left part of this icon  to take a picture during video recording.

Touch the right part of this icon  to pause video recording and touch  to continue. Touch  to stop recording. The video will be automatically saved.

Further operations when viewing a photo/video you have taken

- Slide left or right to view the photos or videos you have taken.
- Touch  , then Gmail/Bluetooth/MMS/etc. to share the photo or video.
- Touch **Back key**  to return to **Camera**.

7.1.1 Modes and settings

Modes

Slide left or right to switch between modes.

- **More:** By selecting More, you can access more modes. These modes could be moved to the main screen by touching  .

Slo-Mo: Record special occasions and fast moving scenes even in a dark environment, then play them back at a slow frame rate.

Stop motion: Capture a number of photos of a certain scene, then convert them into a speed up video.

Light trace: Capture creative movements of light using a long exposure photograph.

Pano: Touch to turn on the panorama function. Touch the shutter button to start taking a panoramic photo and move the phone steadily along the direction indicated by the onscreen line. Once the slots are filled, the photo will be automatically saved. If the slots are not fully filled, touch the shutter button again to save the photo.

Super macro: Touch to access super macro mode. 2-10cm is the best macro shooting distance.



High Pixel (64M): When capturing pictures the device will only use the 64M rear Camera. The photos are larger and more exquisite than the details taken in the auto mode. This mode works only in partially bright scenes, such as when the sun is shining.

- **Auto:** Auto is the default mode for Camera.
- **Video:** Touch to access video mode.
- **Portrait:** Touch to create a depth of field effect. You can compose an image that highlights your subject while producing a gorgeously blurred background.
- **Super night:** This mode helps to capture wonderful pictures at night with low light.
- **Pro:** Pro camera mode lets you fine-tune parameters and gives you full control over ISO, WB exposure time, aperture, shutter speed and so on.

Settings

Touch  to set more options:

- **Photo size:** Touch to select photo size.
- **Video quality:** Touch to select video quality.

- **Video stabilization (EIS):** Touch to turn on/off.
- **AI camera:** Touch to turn on/off AI noise reducing function and AI anti-shaking with Neural network learning solution.
- **Calorie detection⁽¹⁾:** Turn on  to detect the calorie content of a captured object.
- **AI composition⁽¹⁾:** Touch to turn on/off.
- **Dark shot:** Touch to turn on/off.
- **Volume button function:** Touch to enable the Volume button to move between the following options: Shutter, Zoom and Volume.
- **Touch to capture:** Touch to turn on/off. Once turned on, the image will be captured by simply touching the viewfinder screen.
- **Grid:** Touch to turn on/off. It divides the screen into equal parts and helps you take better photos by making it simple to align elements such as the horizon or buildings, to the lines in the grid.
- **Triplecam:** Touch to turn on/off. Once turned on, you will see the icon  in Auto mode. Touch this to choose between Original, Ultra Wide or Low light video mode when capturing.
- **Storage:** Touch to choose between phone and SD card storage when an SD card is inserted. The default is phone storage.
- **Save location information:** Turn on  to tag photos and videos with your location. This option is available when the GPS location service is enabled.
- **Shutter sound:** Touch to turn on/off shutter sound when capturing.
- **Watermark:** Touch to turn on/off Watermark.
- **Reset settings:** Touch to reset the camera to its factory default settings.

⁽¹⁾ Only available when the AI camera is turned on.

Two more options are available when you switch to using the front camera:

- **Face beauty:** Touch  to adjust skin smoothing and enhance coloring effect to portraits.
- **Mirror camera:** Touch to turn on/off.

7.2 Gallery



Gallery acts as a media player for you to view photos and play videos. In addition, a set of further operations to pictures and videos are available for selection.

To view the photos you have taken, touch  from the app drawer.

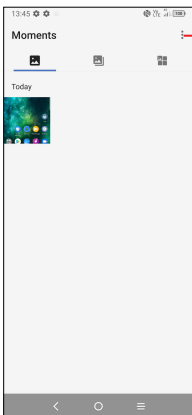

Select photos for further operation







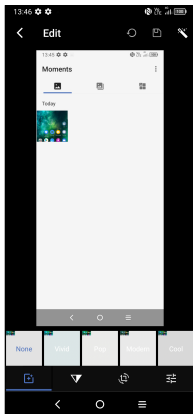
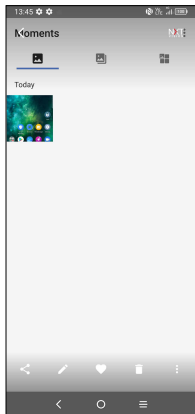

Pictures and videos are displayed by **Moments**, **Albums**, and **Explore** in the **Gallery**.

Working with pictures

You can work with pictures by rotating or cropping them, sharing them with friends, setting them as a contact photo or wallpaper, etc.

Find the picture you want to work on, and touch the picture in the full-screen picture view.



- Touch  to share the picture.
- Touch  to edit the picture.
-  Choose picture effect.
-  Set as None or Dehaze.
-  **Crop, Straighten, Rotate, Mirror, or Draw** the picture.
-  Adjust the picture color.
- Touch  to set the picture as your favorite.
- Touch  to delete the picture.
- Touch  **Set as** to set the picture as a Contact photo or Wallpaper.

8 Others.....

8.1 Radio⁽¹⁾.....



Your phone is equipped with a radio⁽²⁾ with RDS⁽¹⁾ functionality. You can use the application as a traditional radio with saved channels or with visual information related to the radio program displayed if you turn to stations that offer Visual Radio service.



To listen to the radio, you must insert headphones. Headphones act as the radio antenna.

To listen to a radio program, touch  from the app drawer.

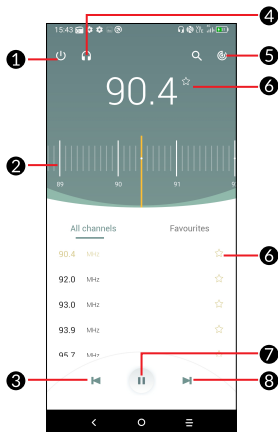

⁽¹⁾ Depending on your network carrier and market.

⁽²⁾ The quality of the radio depends on the coverage of the radio station in that particular area.

- ① Touch to exit radio.
- ② Drag to change current frequency.
- ③ Touch to go to the previous channel.
- ④ Touch to enable/disable the loudspeaker.
- ⑤ Touch to scan channels.
- ⑥ Touch to add/remove the current station to/from favorites.
- ⑦ Touch to play/stop.
- ⑧ Touch to go to next saved channel.

8.2 IR Remote.....



IR Remote through infrared sensor to help you remote control home appliances anytime, anywhere, to solve the pain caused by excessive household appliances, provide 10 remote control device functions . Home appliances such as TV, Set-up Box , AIRCON, Net box, DVD, Air cleaner, Fan, Power amplifier, Water heaters.

1. Enter the IR Remote and select the type of remote control, such as TV.
2. Select the current Region and choose a TV brand.
3. Aim the infrared emission hole at the top of the phone at the TV and touch the button to send infrared signals.
4. Select Yes or No according to the appliances response.
5. Save the IR remote.

8.3 Support Center



Support Center helps you to learn more about Hot FAQs, operation instructions, troubleshooting, etc. use it to send us your feedback.

8.4 Other applications ⁽¹⁾

The previous applications in this section are preinstalled on your phone. To download and install more 3rd party applications, use the Google Play Store application.

⁽¹⁾ Application availability depends on country and carrier.

9 Google applications.....

Google apps are preinstalled on your phone to improve work efficiency and help you enjoy life.

This manual briefly introduces the apps. For detailed features and user guides, refer to related websites or the introduction provided in the apps.

You are recommended to register with a Google account to enjoy all the functions.

9.1 Chrome

A web browser with which you can surf the internet.

Your bookmarks, browsing history, and settings across all devices with the browser installed can be synchronized with your Google account.

9.2 Gmail

As Google's web-based email service, Gmail is configured when you first set up your phone. With this application, you can send and receive emails, manage emails by labels, archive emails, etc. Emails can be automatically synchronized with your Gmail account.

9.3 Maps

Google Maps offers satellite imagery, street maps, 360° panoramic views of streets, real-time traffic conditions, and route planning for travelling by foot, car, or public transportation. By using this application, you can get your own location, search for a place, and get suggested route planning for your trips.

9.4 YouTube

YouTube is an online video-sharing application where users can upload, view, and share videos. Available content includes video clips, TV clips, music videos, and other content such as video blogging, short original videos, and educational videos. It supports a streaming function that allows you to start watching videos almost as soon as they begin downloading from the internet.

9.5 Drive

A file storage and synchronization service created by Google, which allows users to store files in the cloud, share and edit files.

Files in Drive are kept secure and can be accessed from any device by logging in to your Google account. Files or folders can be shared privately with other Google account users.

9.6 Play Store

Serves as the official app store for the Android operating system, allowing users to browse and download applications and games. Applications are either free of charge or at a cost.

In Play Store, search for the app you need, download it and then follow the installation guide to install the app. You can also uninstall, update an app, and manage your downloads.

9.7 Duo

A video chat mobile app.

With phone numbers verified, users can easily video call people from their contact list.

9.8 Photos

Google Photos stores and backs up your photos and videos. It also automatically analyzes photos and organizes them into groups, so that you can quickly find the photos you need.

9.9 Keep notes

A note taking application developed by Google.

You can insert images, lists, and make voice recordings in your notes. You can also set time or location-based reminders for notes. Google Keep allows you to categorise notes by labels, and notes are searchable based on their color, whether they have reminders, audio, images, or lists.

9.10 Google Assistant

Devices can have a dedicated hardware button for the Google Assistant. With a GA-button, users can launch the Google Assistant in three different modes: Default , Visual snapshot, and Walk talkie.

9.11 Files

Files displays all data stored on the phone, including both external SD card and internal storage, such as applications, media files downloaded from Google Play Store, YouTube or other locations; Videos, pictures or audios you have captured; other data transferred via Bluetooth, USB cable, etc.

10 Settings



To go to Settings, touch  from the app drawer.

10.1 Networks & internet

10.1.1 Wi-Fi

Using Wi-Fi you can access the internet without using your SIM card whenever you are in range of a wireless network. The only thing you have to do is to enter the Wi-Fi screen and configure an access point to connect your phone to the wireless network.

For detailed instructions on using Wi-Fi, refer to “6.1.2 Wi-Fi”.

10.1.2 Cellular network

You can set **Data roaming**, **VoLTE**, **Preferred network type**, **Network** and **Access Point Names** etc. in this menu.

10.1.3 Data usage

Data saver

By enabling **Data saver**, you can reduce data usage by preventing some apps from sending or receiving data in the background.

Cellular data

If you do not need to transmit data on cellular networks, turn off **Cellular data** to avoid incurring significant charges for data use on local carrier cellular networks, particularly if you do not have a cellular data agreement.



Data usage is measured by your phone, and your carrier may count differently.

10.1.4 Hotspot & tethering

This function allows you to share your phone's cellular data connection via USB or as a portable Wi-Fi access point (refer to “6.4 Sharing your phone's cellular data connection”).

10.1.5 VPN

For more information on VPN, refer to “6.5 Connecting to virtual private networks”.

10.1.6 Airplane mode

Turn on **Airplane mode**  to simultaneously disable all wireless connections including Wi-Fi, Bluetooth and more. However, Wi-Fi and Bluetooth can still be enabled manually later if needed.

10.1.7 Private DNS

Touch to select private DNS mode.

10.2 Bluetooth & device connection

10.2.1 Bluetooth

Bluetooth allows your phone to exchange data (videos, images, music, etc.) within a small range with another Bluetooth supported device (phone, computer, printer, headset, car kit, etc.).

For more information on Bluetooth, refer to “6.2 Connecting to a Bluetooth device”.

10.2.2 NFC

Turn on  to enable NFC.

The function allows data exchange when the phone touches another device.

10.2.3 Cast

You can use Cast to display your device's screen on your TV, and display content like TV shows, movies, photos, games, and websites from supported apps.

10.2.4 USB

You can use USB to charge this device, transfer files or transfer photos (PTP).

10.2.5 Printing

Touch Printing to activate print services. You can select your **Default print service** or choose **Add service** to select another service.

10.3 Display

10.3.1 Status bar

With this menu, you can set the style of the status bar, select whether notification icons are folded and how the battery percentage is displayed.

10.3.2 Notch

Turn on for full screen apps to get the best experience on the phone.

10.3.3 Full screen apps

Most applications installed on the phone will automatically adapt to the full screen display without setting them manually.

For the applications which do not automatically adapt to the full screen display, you can go to **Settings > Display > Full screen apps** to set.

10.3.4 Brightness level

Adjust screen brightness manually.

10.3.5 Dark mode

Your screen will become black in this mode, which makes it easier to look at your screen or read in dim light.

10.3.6 Eye comfort mode

Eye comfort mode can effectively reduce blue light radiation and adjust the color temperature to relieve eye fatigue. You can also create a custom schedule to turn on it.

10.3.7 Adaptive brightness

Adjust screen brightness automatically.

10.3.8 Auto-rotate screen

Select whether the screen rotates automatically or not.

10.3.9 Sleep

Set screen timeout.

10.3.10 Font size

Slide to make the text on screen smaller or larger.

10.3.11 Ambient display

Turn on  to wake screen when you receive new notifications.

It will be disabled when **Always on display** is on.

10.3.12 Always On Display

Turn on  to always show time, data and pattern on display.

You also can set styles and schedule time.

10.3.13 Flip cover mode

Turn on  **Flip cover mode** for full functionality of your flip cover.

10.3.14 Notification light

Turn on  to display notification with light effect.

10.4 NXTVISION

10.4.1 Visual enhancement

Toggle the switch to enable. Automatically adjust contrast, sharpness and saturation to make the screen image clearer, with a richer depth of detail and improved brightness for dark scenes when viewing photos or playing videos and games. Only works in 'Vivid' Screen color mode.

10.4.2 SDR to HDR

This is only available after enabling visual enhancement.

Enhance the color, contrast and depth of detail of streaming video from any source to provide HDR-quality viewing.

10.4.3 Reading mode

Reading mode reproduces a physical book reading experience on your screen. You can set individual apps to use this mode by clicking Manage apps menu.

10.4.4 Screen color

The device allows you to change the range of display tones according to the display content. When choosing Vivid, you can adapt the screen's color temperature according to the ambient light.

10.5 Home screen & wallpapers

With this menu, set your home apps, choose your favorite wallpapers, theme styles, and etc.

10.6 Sound

Use the Sound settings to configure many aspects of phone ringtones, music, and other audio settings.

10.6.1 Do Not Disturb preferences

If you do not want to be disturbed by your phone or information ringtones during work or rest, you can set the Do Not Disturb mode.

Swipe down the Status bar twice to access the Quick Settings panel and tap to turn on Do Not Disturb.

10.6.2 Phone ringtone

Set your incoming call ringtone.

10.6.3 Default notification ringtone

Set the default ringtone for notifications.

10.6.4 Default alarm ringtone

Set your alarm ringtone.

10.6.5 Other sounds and vibrates

Set dial pad tones, screen locking sounds, tap sounds, etc.

10.7 Advanced features

10.7.1 System navigation

Select your favorite navigation button layout.

10.7.2 App Cloner



App Cloner will duplicate one app on your Home screen and you can enjoy both of them respectively at the same time.

10.7.3 Edge Bar

Edge bar provides quick access to the most useful apps and features. It aims to bring more convenience to the user through shortcuts for apps along with other features. Currently, three bars are included in this feature, which are Apps, Contacts, and Ruler.

You can simply swipe the Edge bar handle from the edge of the screen. All the edge bars are enable by default; however, you can still select the bars you'd like to use.

- Touch  to add item from the all available items list on the right. Each bar can be accommodated up to 12 items.
- Touch an icon to open or run the item.

- Long press any icon to enter edit mode. You can remove the item by touching the  icon, then touch **Done**.
- Touch the  icon on the right button corner to enter Settings. This menu offers various customization options, such as On/Off Edge bar, Continuous switch tabs, Disable edge bar when using full-screen apps, edit tabs etc. Touch **Edit edge bar position** then tap anywhere to relocate the handle on the edge of the screen.

10.7.4 Screen Recorder

Set the video resolution and sound.

To activate Screen Recorder, touch the  icon in the Quick Settings panel.

10.7.5 Gestures

To set some gestures for convenient use, such as flip to mute, 3 fingers screenshot, split screen, and etc.

10.7.6 One-handed mode

Reduce the display area of the screen and operate your phone with one hand. The function could access in the Quick Settings panel by touching the  icon.

10.7.7 Game mode

Games can be automatically or manually added to **My Game** list. Add games to the list to enable Game mode automatically when playing games.

Do not disturb while game

Turn on **Block notification** and **Constant brightness** to create a nice environment for gaming.

Prevent accidental touches

Turn on **Double check for the gesture**, in full screen games, the full screen gestures need to be double swipe to take effects.

Three-finger screen capture and Smart key will be disabled while gaming after turned on.

Game optimization

Game turbo will clean the background apps and increase the power consumption to make a best performance for playing game. The other apps network usage will be limited when game mode is on.

10.7.8 Driving Mode

A series of settings in Driving mode makes it easier and safer to handle incoming calls when you are driving. To view more instructions, tap in **Settings > Advanced features > Driving mode**.

10.7.9 Smart Key⁽¹⁾

You can customize a variety of powerful features to make the use of the phone more convenient.

Touch **Single press**, **Double press** or **Long press**, then set **Action** as **Open an app** or **Open a feature**, and then set a shortcut for an **App** or a **feature**.

⁽¹⁾ Smart key will be replaced by Google Assistant in some regions.

10.7.10 Switch Phone

Switch Phone helps you to transfer content from an old phone to a new one, tap the  icon to view Q & A.

10.8 Smart Manager

Smart Manager ensures your phone is operating in top form by automatically scanning and optimizing data usage to preserve battery levels, manage storage and protect against security threats.

Restricting auto-start apps can make the system run faster and extend battery life.

You can also do some manual settings for further optimization.

10.9 Security

10.9.1 Screen lock

Select one method such as Swipe, Pattern, PIN, Password, or Fingerprint to unlock the screen.

10.9.2 Fingerprint

Use your Fingerprint to unlock the screen or clear notifications, take a photo/video, pick up a call, and etc.

Access **Settings > Security > Fingerprint** to activate these functions.

10.9.3 Face key

Face key allows you to unlock your device with your facial data. Set it according to the on-screen steps.

Ensure that you are facing the phone screen when using face recognition.

Note: you need to set a pattern, PIN, or password before using face key.

10.9.4 Smart Lock

Smart Lock keeps your device unlocked when it's safe with you and locked when it detects that it's been put down.

10.9.5 Apps lock

Apps lock can effectively protect your privacy by locking some apps with a pattern or fingerprint. Go to **Settings > Security > Apps lock** to set the lock format, lock time and choose the apps you want to lock.

10.9.6 Others

You can also set Emergency service, SIM card lock, Screen pinning, and etc. in **Settings > Security**.

10.10 Location

Tap to set whether to allow an app to access your device's location. You can set allowing all the time, or only while the app is in use.

10.11 Privacy

To protect your privacy, you can set an app to be allowed or forbidden to access your location, SMS, phone, etc. Also whether or not to show passwords or choose the activities and info that you want to Google to save.

10.12 Apps

Touch to view details about the applications installed on your phone, to manage their data usage or force them to stop.

In the **App permissions** menu of an application, you can grant permissions for the app, such as allowing the app to access your Camera, Contacts, Location, etc.

10.13 Storage

Use these settings to monitor the total and available space on your phone.

10.14 Account

Touch to add, remove, and manage your email and other supported accounts. You can also use these settings to control how and whether all applications send, receive, and synchronize data according to their own schedules, and whether all applications can synchronize user data automatically.

Touch **Add account** to add an account for the selected app.

10.15 Digital Wellbeing & parental controls

In this menu you can find how much time you have spent on the phone and even on each app. You can customize the time limit for using the phone so that have a healthy and balanced life.

In addition, parents are able to restrict their children's usage time to manage their browsing habits.

10.16 Google

Touch to configure your Google account and services settings.

10.17 Accessibility

Use the Accessibility settings to configure any accessibility plug-ins you have installed on your phone.

10.18 System

10.18.1 About phone

View basic information for your phone such as model name, CPU, camera, resolution, etc.

You can also check legal information, build number, status and other specs.

10.18.2 System updates

If you want to update the system, touch **CHECK FOR UPDATES** (refer to “11.1 FOTA upgrade”).

10.18.3 Languages & input

Touch to configure language settings, the on-screen keyboard, voice input settings, pointer speed, and etc.

10.18.4 Date & time

Use Date & time settings to customize your preferences for how date and time are displayed.

10.18.5 Backup

Turn on  to back up your phone's settings and other application data to Google servers. If you replace your phone, the settings and data you've backed up will be restored onto the new phone when you sign in with your Google account. If you mark this option, a wide variety of settings and data are backed up, including your Wi-Fi passwords, bookmarks, a list of the applications you've installed, the words you've added to the dictionary used by the onscreen keyboard, and most of the settings that you configure in the Settings application. If you unmark this option, you stop backing up your settings, and any existing backups are deleted from Google servers.

10.18.6 Reset

Touch to choose **Network settings reset** (including Wi-Fi, Cellular data & Bluetooth), **Reset app preferences**, or **Factory data reset**.



Factory data reset will erase all of your personal data from the internal phone storage, including information about your Google account, any other accounts, your system and application settings, and any downloaded applications. We recommend you back up your personal data before resetting.

10.18.7 Regulatory & safety

Touch to view product information such as Product model, Manufacturer name, IMEI, CU reference, Bluetooth Declaration ID, and etc.

11 Making the most of your phone

11.1 FOTA upgrade

Use the FOTA (Firmware Over The Air) upgrade to update your phone's software.

To access updates, from the app list, touch **Settings** > **System** > **System updates**. Turn on data connection or Wi-Fi before searching for updates.

With Wi-Fi turned on, the system is able to discover if a new firmware version is available and if so, begin to download it automatically. Once finished, a pop up dialog will give you the option of updating your phone now or later.

If **Settings** > **System** > **System updates** >  > **Settings** > **Automatically download** is turned off, a pop up dialog will ask if you want to download a new firmware version which the phone has discovered, or if you want to ignore it.

If you only have a cellular network connection, you will only receive a notification which will appear in the Status bar.

During FOTA downloading or updating, to avoid errors in locating the correct update packages, do not change your default storage location.

12 Accessories

Standard accessories

- Charger
- USB Cable
- SIM Card Pin



- Accessories depend on countries.
- Only use the TCL batteries, chargers, and accessories included along with your device.

13 1 YEAR LIMITED WARRANTY.....

For information on warranty of your device, visit the USA and Canada websites at <https://www.tclcanada.com/ca/mobile/warranty>

14 Electronic Information

For more information on Electronic Recycling:

- 1) Visit TCL Electronic Recycling Program website at <https://www.tclcanada.com/ca/mobile/accessibility-compliance/electronic-recycling-program/>, or
- 2) Call TCL USA Customer Support at 1-855-224-4228.

Battery Recycling (USA & Canada):

TCL partners with Call2Recycle® to offer a safe and convenient battery recycling program. For more information on our Battery Recycling Program, please visit the USA and Canada website at <https://www.tclcanada.com/ca/mobile/accessibility-compliance/battery-recycling/>

15 Troubleshooting

Before contacting the service center, here are some instructions to help you troubleshoot your device:

- For optimal operation, fully charge the battery.
- To improve the phone's performance, remove unnecessary files or apps on your phone.
- Update your phone's software via **Settings > System > System updates**.
- Reset your phone via **Settings > System > Reset > Factory data reset**. Another method is to hold down the **Power** key and the **Volume up** key at the same time when your phone is powered off. Select **Wipe data / factory reset > Yes > Factory data reset** to reset. All your phone data will be lost permanently. It is strongly advised to fully back up your phone data before resetting.

and carry out the following checks:

My phone can't be switched on or is frozen

- When the phone can't be switched on, charge for at least 20 minutes to ensure the minimum battery power needed. Then switch it on again.
- When the phone falls into a loop during power on animation and the user interface can't be accessed, press and hold the **Power** key to reset. This eliminates any abnormal OS booting issues caused by third party applications.
- If neither method is effective, reset the phone by pressing the **Power** key and the **Volume up** key at the same time, then select **Wipe data / factory reset > Yes > Factory data reset** to reset.

My phone has not responded for several minutes

- If your phone doesn't respond, turn off your phone by pressing and holding the **Power** key until it turns off and then restart it again.

- If it still doesn't work, reset the phone.

My phone turns off by itself

- Check that your screen is locked when you are not using your phone, and make sure that the **Power** key is not accidentally pressed while the screen is unlocked.
- Check the battery charge level.
- If it still doesn't work, reset the phone or update software.

My phone can't charge properly

- Make sure that you are using the TCL charger that comes with the phone.
- Make sure that your battery is not completely discharged; if the battery power has been empty for a long time, it may take around 20 minutes to display the battery charging indicator on the screen.
- Make sure that charging is carried out under normal conditions 0°C (32°F) to 45°C (113°F).
- When abroad, check that the voltage input is compatible.

My phone can't connect to a network or "No service" is displayed

- Try connecting to the network by moving to another physical location.
- Verify the network coverage with your carrier.
- Check with your carrier that your SIM card is valid.
- Try connecting at a later time if the network is overloaded.

My phone can't connect to the internet

- Make sure that the internet access service of your SIM card is available.
- Check your phone's internet connection settings.
- Make sure that you are in a place with network coverage.
- Try connecting at a later time or another location.

Invalid SIM card

- Make sure that the SIM card has been correctly inserted.
- Make sure that the chip on your SIM card is not damaged.
- Make sure that the service of your SIM card is available.

My phone can't make outgoing calls

- Make sure that you have dialed a valid number and have touched .
- For international calls, check the country and area codes.
- Make sure that your phone is connected to a network, and the network is not overloaded or unavailable.
- Check your subscription status with your carrier (credit, SIM card valid, etc.).
- Make sure that you have not barred outgoing calls.
- Make sure that your phone is not in airplane mode.

My phone can't receive incoming calls

- Make sure that your phone is switched on and connected to a network (check for overloaded or unavailable network).
- Check your subscription status with your carrier (credit, SIM card valid, etc.).
- Make sure that you have not forwarded incoming calls.
- Make sure that you have not barred certain calls.
- Make sure that your phone is not in airplane mode.

The caller's name/number doesn't appear when a call is received

- Check that you have subscribed to this service with your carrier.
- Your caller may have concealed his name or number.

I can't find my contacts

- Make sure that your SIM card is not broken.

- Make sure that your SIM card is inserted properly.

The sound quality of the calls is poor

- Adjust the volume during a call by pressing the **Volume** key.
- Check the network strength. Move to a location with stronger signal strength.
- Make sure that the receiver, connector and speaker on your phone are clean.

I can't use the features described in the manual

- Check with your carrier to make sure that your subscription includes this service.
- Make sure that this feature doesn't require a TCL accessory.

When I select a number from my contacts, the number can't be dialed

- Make sure that you have correctly recorded the number in your contacts.
- Make sure that you have selected the country code when calling an international number.

I can't add a contact

- Make sure that your SIM card contacts are not full; delete some contacts or save the contacts to the phone.

My callers can't leave messages on my voicemail

- Contact your network carrier to check service availability.

I can't access my voicemail

- Make sure that your carrier's voicemail number is correctly entered in "Voicemail number".
- Try later if the network is busy.

I can't send and receive MMS

- Check your phone storage as it might be full.

- Contact your network carrier to check service availability and MMS parameters.
- Verify the server center number or your MMS profile with your carrier.
- The server center may be swamped. Try again later.

SIM card PIN locked

- Contact your network carrier to obtain the PUK (Personal Unblocking Key) code.

I can't connect my phone to my computer

- Check to make sure the USB port is not broken. If it's not working, try another USB port on your computer.
- Make sure USB drivers are properly installed.
- If you are using a Windows computer, make sure it supports MTP mode. If you are using a Mac, make sure to install Android File Transfer from www.android.com/filetransfer/.

I can't download new files

- Make sure that there is sufficient phone storage space for your download.
- Select the microSD card as the location to store downloaded files.
- Check your subscription status with your carrier.

The phone can't be detected by others via Bluetooth

- Make sure that Bluetooth is turned on and your phone is visible to other users.
- Make sure that the two phones are within Bluetooth's detection range.

The battery drains too fast

- Make sure that you follow the complete charge time (minimum 120 minutes).

- After a partial charge, the battery level indicator may not be exact. Wait for at least 20 minutes after removing the charger to obtain an exact indication.
- Adjust the brightness of screen as appropriate.
- Extend the email auto-check interval for as long as possible.
- Update news and weather information on manual demand, or increase their auto-check interval.
- Exit background-running applications if they are not being used for extended periods of time.
- Turn off Bluetooth, Wi-Fi, or GPS when not in use.

The phone becomes warm following prolonged calls, game playing, internet surfing or running other complex applications

- This heating is a normal consequence of the CPU handling excessive data. Ending the above actions will make your phone return to normal temperature.

After a factory data reset is performed, I can't use my phone without entering Google account credentials

- After a reset is performed, you must enter the original Google account credentials that were used on this phone.
- If you don't remember your Google account credentials, complete Google account recovery procedures.
- If you still cannot access your phone, apply to the authorized repair center, but remember that it will not be regarded as a warranty case.

I forgot some passwords/codes/keys on phone

- Perform a factory data reset.
- If you still cannot access your phone, apply to the authorized repair center, but remember that it will not be regarded as a warranty case.

16 Specifications

Processor:

- Qualcomm Snapdragon 675

Platform:

- Android Q

Memory:

- 128GB ROM + 6GB RAM

Dimensions (LxWxT):

- 158.5 x 72.4 x 8.6~9.2mm

Weight:

- 177g

Display:

- 6.47" touch screen with 2340x1080

Network:

- GSM: B2/3/5/8 (1900/1800/850/900)
- UMTS: B1/2/4/5/8 (2100/1900/1700/850/900)
- LTE: B1/2/3/4/5/7/8/12/13/17/25/26/28/38/40/41/66 (2100/1900/1800/1700/850/2600/900/700/700/700/1900/850/700/2600/2300/2500/700)

GPS:

- A-GPS

Connectivity:

- Bluetooth 5.0, CaptX & aptX HD & LDAC & AAC, TWS

- Wi-Fi 802.11 b/g/n for 2.4GHz, 802.11 a/n/ac for 5GHz
- 3.5 mm audio jack
- Type-C USB 2.0

Camera:

- 64M + 2M 2.9µm night shoot + 5M AF Macro + 16M super wide
- 24M front camera

Audio & Video supported formats:

- 3GP, 3G2, AAC, AVI, ADTS, ASF, AWB, FLAC, IMY, MID, MKV, MOV, MP3, MPEG-4, MXMF, OGG, OTA, RTTTL, RTX, WAV, WEBM, XMF

Battery ⁽¹⁾:

- Capacity: 4500 mAh

Expansion Slot:

- microSD™ memory card
(Availability of microSD card up to 256GB)

Special Features:

- GPS/GLONASS/Galileo/Beidou
- G-sensor
- Light Sensor
- Proximity Sensor
- E-Compass
- Gyro

Note: Specifications are subject to change without prior notice.

⁽¹⁾ The original battery has undergone rigorous safety inspections to meet qualification standards, the use of non-original batteries may be dangerous.

DISPL AY GREATNESS

For more information on how to use the phone, please go to tclusa.com and download the complete user manual. Moreover, on the website, you can also find answers to frequently asked questions.