

SAMSUNG

USER MANUAL

SM-N981W
SM-N986W

Table of Contents

Key features

Basics

- 5 Read me first
- 8 Device overheating situations and solutions
- 11 Device layout and functions
- 16 Charging the battery
- 20 Nano-SIM card
- 22 Memory card (microSD card)
(Galaxy Note20 Ultra 5G, Note20 Ultra)
- 24 Turning the device on and off
- 25 Initial setup
- 25 Samsung account
- 26 Transferring data from your previous device (Smart Switch)
- 28 Understanding the screen
- 36 Notification panel
- 39 Screen capture and screen record
- 40 Entering text

Apps and features

- 43 Installing or uninstalling apps
- 44 S Pen
- 59 Phone
- 62 Contacts
- 64 Messages

- 66 Internet
- 67 Camera
- 83 Gallery
- 87 AR Zone
- 91 Bixby
- 93 Bixby Vision
- 94 Bixby Routines
- 96 Multi window
- 98 Samsung Daily
- 99 Samsung Pay
- 101 Samsung Health
- 102 Samsung Notes
- 105 Samsung Members
- 105 Samsung Galaxy
- 106 PENUP
- 106 Galaxy Wearable
- 106 Calendar
- 107 Reminder
- 108 Voice Recorder
- 109 My Files
- 109 Clock
- 109 Calculator
- 110 Game Launcher
- 111 Game Booster
- 112 Samsung Kids
- 112 SmartThings
- 113 Sharing content
- 115 Music Share
- 116 Smart View

- 117 Samsung DeX
- 123 Link to Windows
- 124 Samsung Global Goals
- 124 Google apps

Settings

- 125 Introduction
- 125 Connections
 - 126 Wi-Fi
 - 128 Bluetooth
 - 129 NFC and payment
 - 131 Data saver
 - 131 Mobile data only apps
 - 132 Mobile Hotspot
 - 132 More connection settings
- 134 Sounds and vibration
 - 134 Sound quality and effects
 - 135 Separate app sound
- 135 Notifications
- 136 Display
 - 137 Motion smoothness
(Galaxy Note20 Ultra 5G,
Note20 Ultra)
 - 138 Changing the screen mode or
adjusting the display colour
- 139 Wallpaper
- 139 Themes
- 139 Lock screen
 - 140 Smart Lock
 - 140 Always On Display
- 141 Biometrics and security
 - 142 Face recognition
 - 144 Fingerprint recognition
 - 147 Samsung Pass
 - 149 Secure Folder

- 151 Privacy
- 152 Location
- 152 Accounts and backup
 - 153 Samsung Cloud
- 154 Google
- 154 Advanced features
 - 155 Motions and gestures
 - 156 Dual Messenger
- 156 Digital Wellbeing and parental
controls
- 157 Device care
 - 157 Optimizing your device
 - 157 Battery
 - 158 Storage
 - 158 Memory
 - 158 Security
- 159 Apps
- 159 General management
- 160 Accessibility
- 160 Software update
- 161 About phone

Appendix

- 162 Accessibility
- 179 Troubleshooting
- 184 Removing the battery

Health and Safety

Key features



S Pen

Use a variety of features with the more precise S Pen. Refer to [S Pen](#) for more information.



Samsung Notes

Enjoy more convenient note writing and editing. Refer to [Samsung Notes](#) for more information.



Camera

Take high-resolution, high-quality photos or videos. You can also take professional-level videos in pro video mode. Refer to [Camera](#) for more information.



xCloud

Enjoy high-quality gaming on your mobile device with the xCloud service.



Samsung DeX

Experience multitasking on a large screen with the Samsung DeX wireless connection. Refer to [Samsung DeX](#) for more information.



Link to Windows

Connect your smartphone to a computer and get a seamless experience. Refer to [Link to Windows](#) for more information.

Basics

Read me first

Please read this manual before using the device to ensure safe and proper use.

- Descriptions are based on the device's default settings.
- Some content may differ from your device depending on the region, service provider, model specifications, or device's software.
- The device may require a connection to a Wi-Fi or mobile network when using some apps or features.
- Content (high quality content) that requires high CPU and RAM usage will affect the overall performance of the device. Apps related to the content may not work properly depending on the device's specifications and the environment that it is used in.
- Samsung is not liable for performance issues caused by apps supplied by providers other than Samsung.
- Samsung is not liable for performance issues or incompatibilities caused by edited registry settings or modified operating system software. Attempting to customize the operating system may cause the device or apps to work improperly.
- Software, sound sources, wallpapers, images, and other media provided with this device are licensed for limited use. Extracting and using these materials for commercial or other purposes is an infringement of copyright laws. Users are entirely responsible for illegal use of media.
- You may incur additional charges for data services, such as messaging, uploading and downloading, auto-syncing, or using location services depending on your data plan. For large data transfers, it is recommended to use the Wi-Fi feature.
- Default apps that come with the device are subject to updates and may no longer be supported without prior notice. If you have questions about an app provided with the device, contact a Samsung Service Centre. For user-installed apps, contact service providers.
- Modifying the device's operating system or installing software from unofficial sources may result in device malfunctions and data corruption or loss. These actions are violations of your Samsung licence agreement and will void your warranty.



- Depending on the region or service provider, a screen protector is attached for protection during production and distribution. Damage to the attached screen protector is not covered by the warranty.
- You can see the touchscreen clearly even in strong outdoor sunlight by automatically adjusting the contrast range based on the surrounding environment. Due to the nature of the product, displaying fixed graphics for extended periods may result in afterimages (screen burn-in) or ghosting.
 - It is not recommended to use fixed graphics on part or all of the touchscreen for extended periods and to turn off the touchscreen when not using the device.
 - You can set the touchscreen to turn off automatically when you are not using it. Launch the **Settings** app, tap **Display** → **Screen timeout**, and then select the length of time you want the device to wait before turning off the touchscreen.
 - To set the touchscreen to automatically adjust its brightness based on the surrounding environment, launch the **Settings** app, tap **Display**, and then tap the **Adaptive brightness** switch to activate it.
- The use of mobile devices on airplanes or ships may be subject to federal and local guidelines and restrictions. Check with the appropriate authorities and always follow crew instructions regarding when and how you may use your device.
- Depending on the region, you can view the regulatory information on the device. To view the information, launch the **Settings** app and tap **About phone** → **Legal information**.

Maintaining water and dust resistance

Your device supports water- and dust-resistance. Follow these tips carefully to maintain the water- and dust-resistance of your device. Failure to do so may result in damage to your device.

- Do not immerse the device in fresh water deeper than 1.5 m or keep it submerged for more than 30 minutes. If you immerse the device in any liquid other than fresh water, such as salt water, ionized water, or alcoholic beverage, liquid will enter the device faster.
- Do not expose the device to **water moving with force**.
- If the device is exposed to fresh water, dry it thoroughly with a clean, soft cloth. If the device is exposed to other liquids, such as salt water, swimming pool water, soapy water, oil, perfume, sunscreen, hand cleaner, or chemical products such as cosmetics, rinse it with fresh water and dry it thoroughly with a clean, soft cloth. If you do not follow these instructions, the device's performance and appearance may be affected.
- **If the device has been immersed in water or the microphone or speaker is wet**, sound may not be heard clearly during a call. After wiping the device with a dry cloth, dry it thoroughly before using it.
- The touchscreen and other features may not work properly **if the device is used in water**.
- **If the device is dropped or receives an impact**, the water- and dust-resistant features of the device may be damaged.
- **Your device has been tested in a controlled environment and certified to be water- and dust-resistant in specific situations (meets requirements of classification IP68 as described by the international standard IEC 60529-Degrees of Protection provided by Enclosures [IP Code]; test conditions: 15-35 °C, 86-106 kPa, fresh water, 1.5 metre, 30 minutes). Despite this classification, it is still possible for your device to be damaged in certain situations.**

Instructional icons

-  **Warning:** situations that could cause injury to yourself or others
-  **Caution:** situations that could cause damage to your device or other equipment
-  **Notice:** notes, usage tips, or additional information

Device overheating situations and solutions

When the device heats up while charging the battery

While charging, the device and the charger may become hot. During wireless charging or fast charging, the device may feel hotter to the touch. This does not affect the device's lifespan or performance and is in the device's normal range of operation. If the battery becomes too hot, the charging speed may decrease or the charger may stop charging.

Do the following when the device heats up:

- Disconnect the charger from the device and close any running apps. Wait for the device to cool down and then begin charging the device again.
- If the lower part of the device overheats, it could be because the connected USB cable is damaged. Replace the damaged USB cable with a new Samsung-approved one.
- When using a wireless charger, do not place foreign materials, such as metal objects, magnets, and magnetic stripe cards, between the device and the wireless charger.



The wireless charging or fast charging feature is only available on supported models.

When the device heats up during use

When you use features or apps that require more power or use them for extended periods, your device may temporarily heat up due to increased battery consumption. Close any running apps and do not use the device for a while.

The following are examples of situations in which the device may overheat. Depending on the functions and apps you use, these examples may not apply to your model.

- During the initial setup after purchase or when restoring data
- When downloading large files

- When using apps that require more power or using apps for extended periods
 - When playing high-quality games for extended periods
 - When recording videos for extended periods
 - When streaming videos while using the maximum brightness setting
 - When connecting to a TV
- While multitasking (or, when running many apps in the background)
 - When using Multi window
 - When updating or installing apps while recording videos
 - When downloading large files during a video call
 - When recording videos while using a navigation app
- When using large amount of data for syncing with the cloud, email, or other accounts
- When using a navigation app in a car while the device is placed in direct sunlight
- When using the mobile hotspot and tethering feature
- When using the device in areas with weak signals or no reception
- When charging the battery with a damaged USB cable
- When the device's multipurpose jack is damaged or exposed to foreign materials, such as liquid, dust, metal powder, and pencil lead
- When you are roaming

Do the following when the device heats up:

- Keep the device updated with the latest software.
- Conflicts between running apps may cause the device to heat up. Restart the device.
- Deactivate the Wi-Fi, GPS, and Bluetooth features when not using them.
- Close apps that increase battery consumption or that run in the background when not in use.
- Delete unnecessary files or unused apps.
- Decrease the screen brightness.
- If the device overheats or feels hot for a prolonged period, do not use it for a while. If the device continues to overheat, contact a Samsung Service Centre.

Precautions for device overheating

If you begin to feel uncomfortable due to the device overheating, stop using the device.

When the device heats up, the features and performance may be limited or the device may turn off to cool down. The feature is only available on supported models.

- If the device overheats and reaches a certain temperature, a warning message will appear to prevent device failure, skin irritations and damages, and battery leakage. To lower the device's temperature, the screen brightness and the performance speed will be limited and battery charging will stop. Running apps will be closed and all calling and other features will be limited, except for emergency calls, until the device cools down.
- If the second message appears due to a further increase of the device's temperature, the device will turn off. Do not use the device until the device's temperature drops below the specified level. If the second warning message appears during an emergency call, the call will not be disconnected by a forced shut down.

Precautions for operating environment

Your device may heat up due to the environment in the following conditions. Use caution to avoid shortening the battery's lifespan, damaging the device, or causing a fire.

- Do not store your device in very cold or very hot temperatures.
- Do not expose your device to direct sunlight for extended periods.
- Do not use or store your device for extended periods in very hot areas, such as inside a car in the summertime.
- Do not place the device in any areas that may overheat, such as on an electric heating mat.
- Do not store your device near or in heaters, microwaves, hot cooking equipment, or high pressure containers.
- Do not use a cable whose covering is peeled off or damaged, and do not use any charger or battery that is damaged or malfunctioning.

Device layout and functions

Package contents

Refer to the quick start guide for package contents.



- The items supplied with the device and any available accessories may vary depending on the region or service provider.
- The supplied items are designed only for this device and may not be compatible with other devices.
- Appearances and specifications are subject to change without prior notice.
- You can purchase additional accessories from your local Samsung retailer. Make sure they are compatible with the device before purchase.
- Use only Samsung-approved accessories. Using unapproved accessories may cause performance problems and malfunctions that are not covered by the warranty.
- Availability of all accessories is subject to change depending entirely on manufacturing companies. For more information about available accessories, refer to the Samsung website.
- The supplied earphones (USB Type-C) that support digital output are designed only for this device. They may not be compatible with other devices that use different audio output method.

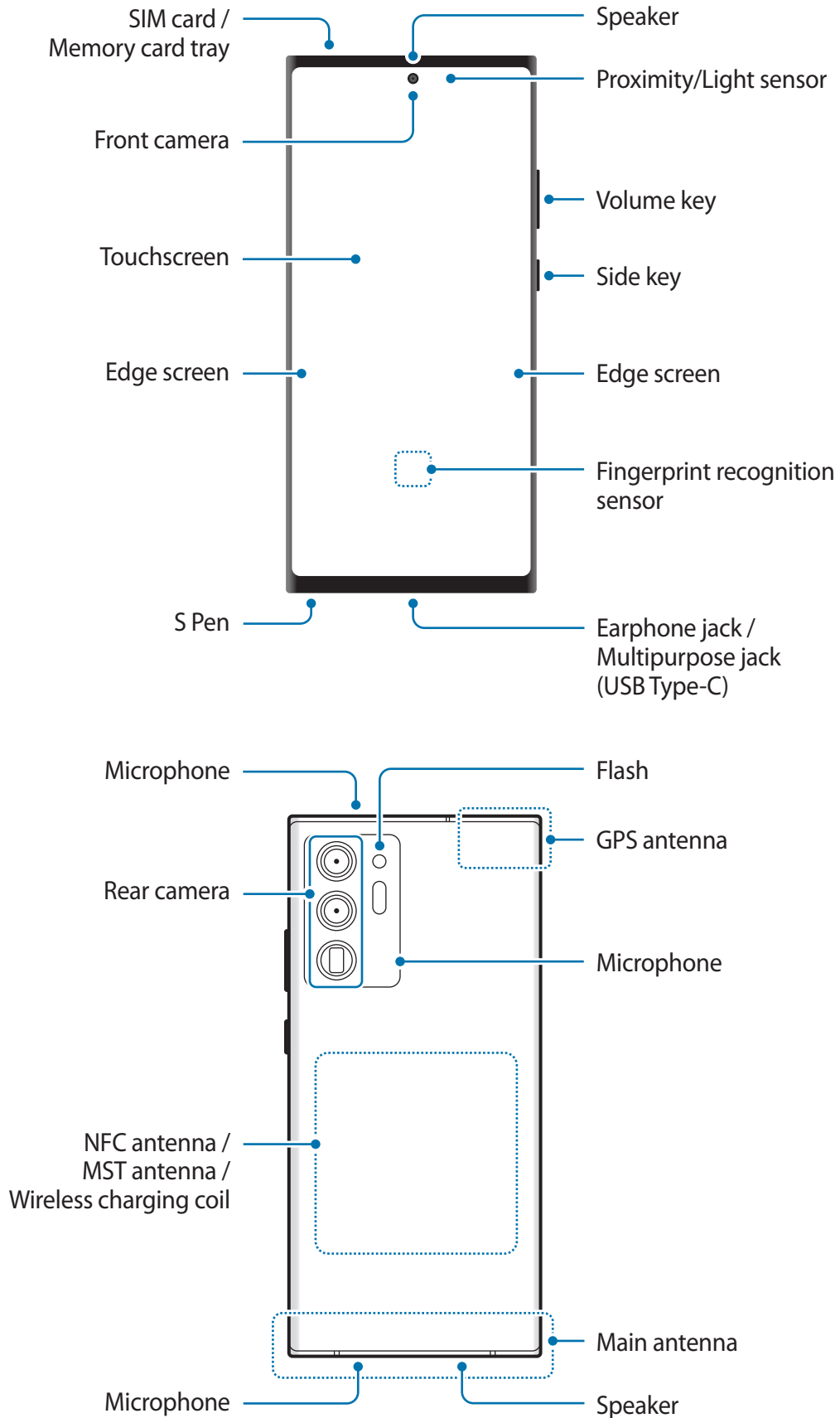

Device layout

► Galaxy Note20 Ultra 5G, Note20 Ultra:

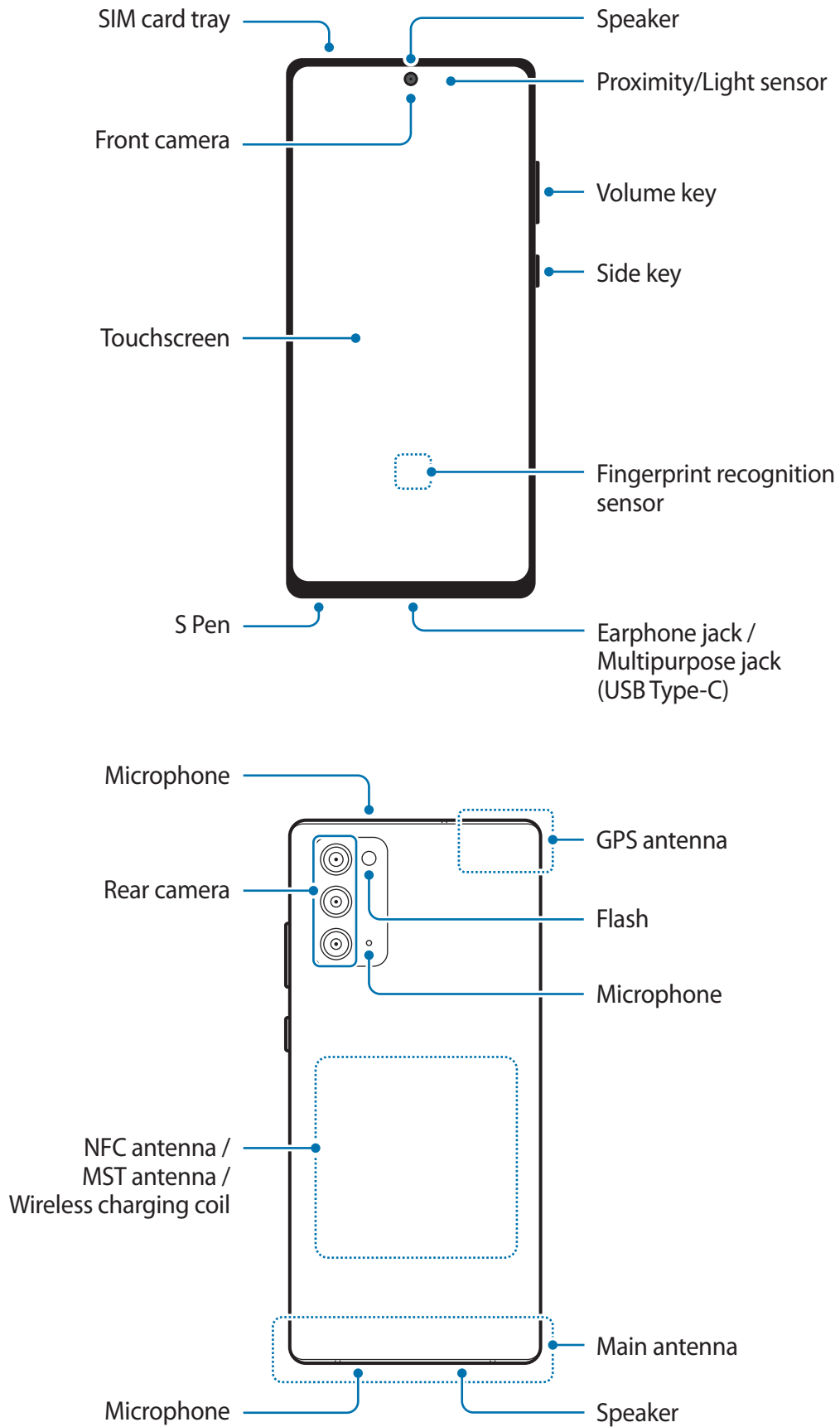

► Galaxy Note20 5G, Note20:



-  When using the speakers, such as when playing media files or using speakerphone, do not place the device close to your ears.
- Be careful not to expose the camera lens to a strong light source, such as direct sunlight. If the camera lens is exposed to a strong light source, the camera image sensor may be damaged. A damaged image sensor is irreparable and will cause dots or spots in pictures.
- If you use the device with its glass or acrylic body broken, there may be a risk of injury. Use the device only after it has been repaired at a Samsung Service Centre.
- If dust or foreign materials enter the microphone, speaker, or receiver, the device's sound may become quiet or certain features may not work. If you attempt to remove the dust or foreign materials with a sharp object, the device may be damaged and its appearance may be affected.
-  Connectivity problems and battery drain may occur in the following situations:
 - If you attach metallic stickers on the antenna area of the device
 - If you attach a device cover made with metallic material to the device
 - If you cover the device's antenna area with your hands or other objects while using certain features, such as calls or the mobile data connection
- Using a Samsung-approved screen protector is recommended. Unapproved screen protectors may cause the sensors to malfunction.
- Do not cover the proximity/light sensor area with screen accessories, such as a screen protector, stickers, or a cover. Doing so may cause the sensor to malfunction.
- The light may flicker at the top of the device during calls due to proximity sensor operation.
- The colours on the Edge screen may look different depending on your viewing position. (Galaxy Note20 Ultra 5G, Note20 Ultra)

Hard keys

Key	Function
Side key	<ul style="list-style-type: none"> • When the device is off, press and hold to turn it on. • Press to turn on or lock the screen. • Press and hold to start a conversation with Bixby. Refer to Using Bixby for more information. • Press twice or press and hold to launch the app or feature you set.
Side key + Volume Down key	<ul style="list-style-type: none"> • Press simultaneously to capture a screenshot. • Press and hold simultaneously to turn off the device.

Setting the Side key

Select an app or feature to launch by pressing the Side key twice or pressing and holding the Side key.

Launch the **Settings** app, tap **Advanced features** → **Side key**, and then select an option you want.

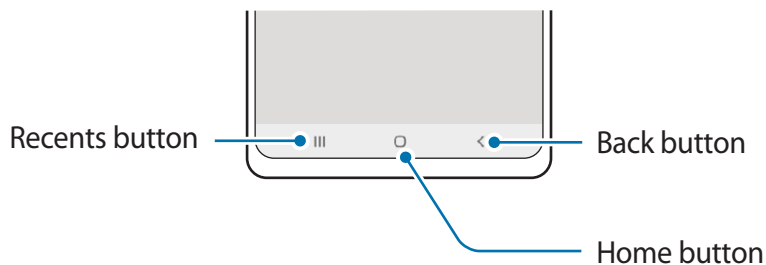

Soft buttons



When you turn on the screen, the soft buttons will appear at the bottom of the screen. Refer to [Navigation bar \(soft buttons\)](#) for more information.

Charging the battery

Charge the battery before using it for the first time or when it has been unused for extended periods.

-  Use only Samsung-approved battery, charger, and cable specifically designed for your device. An incompatible battery, charger, or cable can cause serious injury or damage to your device.
- 
 - Connecting the charger improperly may cause serious damage to the device. Any damage caused by misuse is not covered by the warranty.
 - Only use the USB Type-C cable supplied with the device. The device may be damaged if you use a Micro USB cable.
-  To save energy, unplug the charger when not in use. The charger does not have a power switch, so you must unplug the charger from the electric socket when not in use to avoid wasting power. The charger should remain close to the electric socket and easily accessible while charging.

Wired charging

Connect the USB cable to the USB power adapter and plug the cable into the device's multipurpose jack to charge the battery. After fully charging, disconnect the charger from the device.

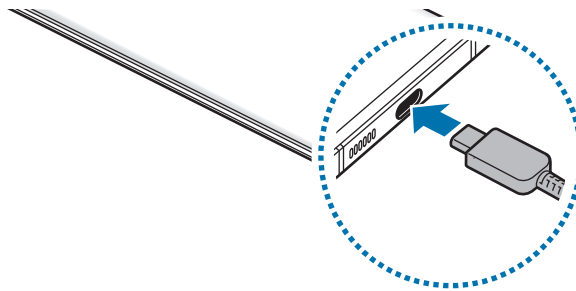

Wireless charging

The device has a built-in wireless charging coil. You can charge the battery using a wireless charger (sold separately).

Place the centre of the device's back on the centre of the wireless charger to charge the battery. After fully charging, disconnect the device from the wireless charger.

The estimated charging time will appear on the notification panel. The actual charging time may vary depending on the charging conditions.

Precautions for wireless charging

- Do not place the device on the wireless charger with a credit card or radio-frequency identification (RFID) card (such as a transportation card or a key card) placed between the back of the device and the device cover.
- Do not place the device on the wireless charger when conductive materials, such as metal objects and magnets, are placed between the device and the wireless charger. The device may not charge properly or may overheat, or the device and the cards may be damaged.
-  • If you use the wireless charger in areas with weak network signals, you may lose network reception.
- Use Samsung-approved wireless chargers. If you use other wireless chargers, the battery may not charge properly.

Quick charging

Launch the **Settings** app, tap **Device care** → **Battery** → **Charging**, and then activate the feature you want.

- **Fast charging:** To use the fast charging feature, use a battery charger that supports Adaptive fast charging.
- **Super fast charging:** To use the super fast charging feature, use a USB PD (Power Delivery) charger that supports Super fast charging.
- **Fast wireless charging:** To use this feature, use a charger and components that support the fast wireless charging feature.
-  • While charging, you cannot activate or deactivate this feature.
- You can charge the battery more quickly while the device or its screen is turned off.
- A fan inside the charger may produce noise during fast wireless charging. If you use the **Turn off as scheduled** option, you can set the fast wireless charging feature to turn off automatically at the preset time. When the fast wireless charging feature turns off, the charger's fan noise and the indicator light will be reduced.

Wireless PowerShare

You can charge another device with your device's battery. You can still charge another device even while charging your device. Depending on the type of accessories or cover being used, the Wireless PowerShare feature may not work properly. It is recommended to remove any accessories and cover being used before using this feature.

- 1 Open the notification panel, swipe downwards, and then tap  (Wireless PowerShare) to activate it.
- 2 Place the other device on the centre of your device, with their backs facing.

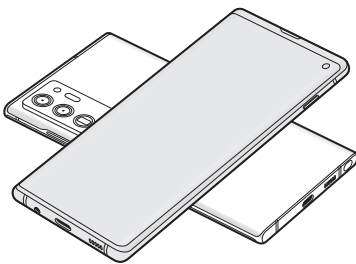

Smartphone

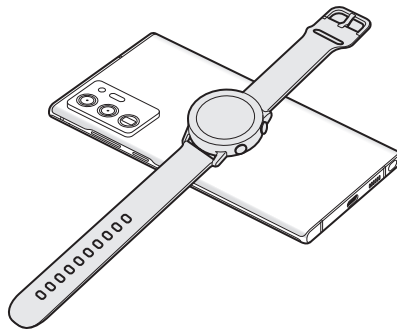

Galaxy Watch

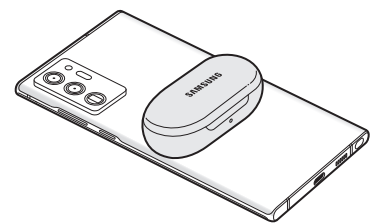

Galaxy Buds

- 3 When you are finished charging, disconnect the other device from your device.

 Do not use earphones while sharing power. Doing so may affect nearby devices.

-  The location of the wireless charging coil may vary by device model. Adjust the devices to connect with each other properly.
- Some features are not available while sharing power.
- Only devices that support the wireless charging feature can be charged using this feature. Some devices may not be charged. To see devices that support the Wireless PowerShare feature, visit the Samsung website.
- To charge properly, do not move or use either device while charging.
- The power charged to the other device may be less than the amount shared to it by your device.
- If you charge the other device while charging your device, the charging speed may decrease or the device may not charge properly depending on the charger type.
- The charging speed or efficiency may vary depending on the device's condition or the surrounding environment.

Setting the limit for power sharing

You can set the device to stop power sharing when the remaining battery power drops below a certain level.

Launch the **Settings** app, tap **Device care** → **Battery** → **Wireless PowerShare** → **Battery limit**, and then set the limit.

Reducing the battery consumption

Your device provides various options that help you conserve battery power.

- Optimize the device using the device care feature.
- When you are not using the device, turn off the screen by pressing the Side key.
- Activate power saving mode.
- Close unnecessary apps.
- Deactivate the Bluetooth feature when not in use.
- Deactivate auto-syncing of apps that need to be synced.
- Decrease the backlight time.
- Decrease the screen brightness.

Battery charging tips and precautions

- If the battery is completely discharged, the device cannot be turned on immediately when the charger is connected. Allow a depleted battery to charge for a few minutes before turning on the device.
- If you use multiple apps at once, network apps, or apps that need a connection to another device, the battery will drain quickly. To avoid losing power during a data transfer, always use these apps after fully charging the battery.
- Using a power source other than the charger, such as a computer, may result in a slower charging speed due to a lower electric current.
- The device can be used while it is charging, but it may take longer to fully charge the battery.

- If the device receives an unstable power supply while charging, the touchscreen may not function. If this happens, unplug the charger from the device.
- While charging, the device and the charger may heat up. This is normal and should not affect the device's lifespan or performance. If the battery gets hotter than usual, the charger may stop charging. If this occurs during wireless charging, disconnect the device from the charger to let it cool down, then charge the device again later.
- If you charge the device while the multipurpose jack is wet, the device may be damaged. Thoroughly dry the multipurpose jack before charging the device.
- If the device is not charging properly, take the device and the charger to a Samsung Service Centre.

Nano-SIM card

Insert the SIM or USIM card provided by the mobile telephone service provider.

Installing the SIM or USIM card

► Galaxy Note20 Ultra 5G, Note20 Ultra:

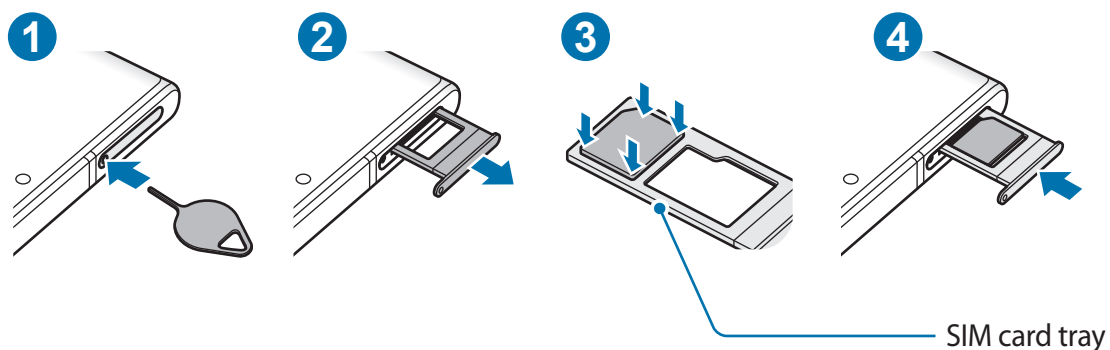

► Galaxy Note20 5G, Note20::

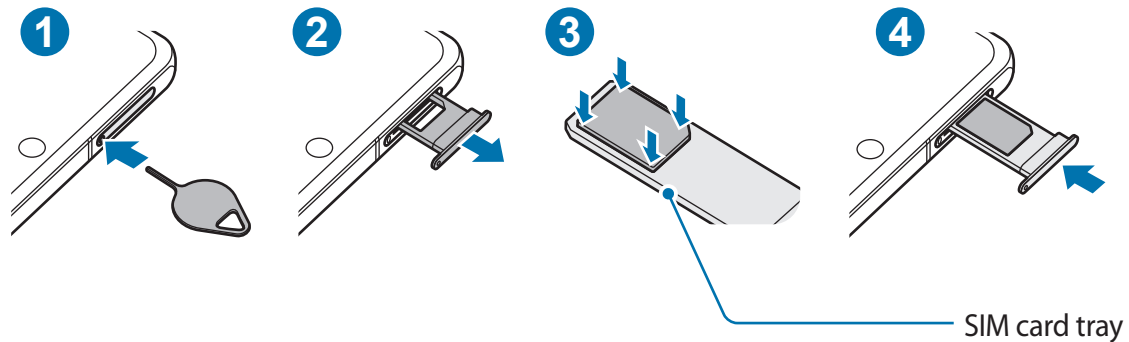

- 1 Insert the ejection pin into the hole on the tray to loosen the tray.
 - 2 Pull out the tray gently from the tray slot.
 - 3 Place the SIM or USIM card on the tray with the gold-coloured contacts facing downwards and gently press the SIM or USIM card into the tray to secure it.
 - 4 Insert the tray back into the tray slot.
- ⚠ • Use only a nano-SIM card.
 - Use caution not to lose or let others use the SIM or USIM card. Samsung is not responsible for any damages or inconveniences caused by lost or stolen cards.
 - Ensure that the ejection pin is perpendicular to the hole. Otherwise, the device may be damaged.
 - If the card is not fixed firmly into the tray, the SIM card may fall out of the tray.
 - If you insert the tray into your device while the tray is wet, your device may be damaged. Always make sure the tray is dry.
 - Fully insert the tray into the tray slot to prevent liquid from entering your device.

Memory card (microSD card) (Galaxy Note20 Ultra 5G, Note20 Ultra)

Installing a memory card

Your device's memory card capacity may vary from other models and some memory cards may not be compatible with your device depending on the memory card manufacturer and type. To view your device's maximum memory card capacity, refer to the Samsung website.

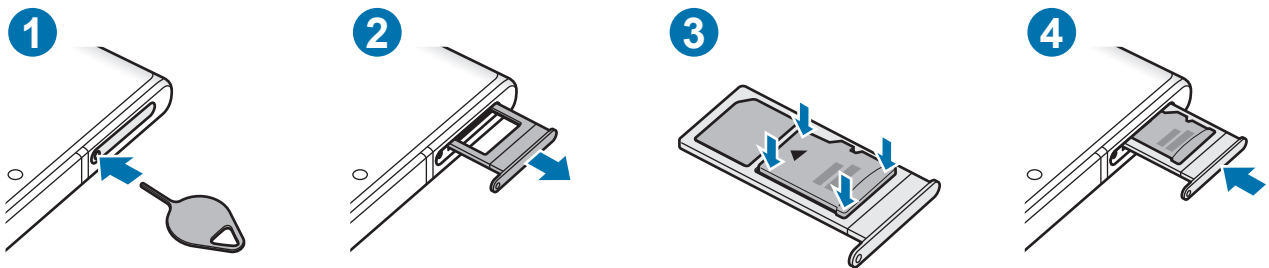

- 1 Insert the ejection pin into the hole on the tray to loosen the tray.
 - 2 Pull the tray gently from the tray slot.
 - 3 Place a memory card on the tray with the gold-coloured contacts facing downwards and gently press the memory card into the tray to secure it.
 - 4 Insert the tray back into the tray slot.
- ⚠ • Some memory cards may not be fully compatible with the device. Using an incompatible card may damage the device or the memory card, or corrupt the data stored in it.
 - Use caution to insert the memory card right-side up.
 - Ensure that the ejection pin is perpendicular to the hole. Otherwise, the device may be damaged.
 - When you remove the tray from the device, the mobile data connection will be disabled.
 - If the card is not fixed firmly into the tray, the memory card may fall out of the tray.
 - If you insert the tray into your device while the tray is wet, your device may be damaged. Always make sure the tray is dry.
 - Fully insert the tray into the tray slot to prevent liquid from entering your device.



- The device supports the FAT and the exFAT file systems for memory cards. When inserting a card formatted in a different file system, the device will ask to reformat the card or will not recognize the card. To use the memory card, you must format it. If your device cannot format or recognize the memory card, contact the memory card manufacturer or a Samsung Service Centre.
- Frequent writing and erasing of data shortens the lifespan of memory cards.
- When inserting a memory card into the device, the memory card's file directory appears in the **My Files** → **SD card** folder.

Removing the memory card

Before removing the memory card, first unmount it for safe removal.

Launch the **Settings** app and tap **Device care** → **Storage** → **Advanced** → **SD card** → **Unmount**.

- ⚠ Do not remove external storage, such as a memory card or USB storage, while the device is transferring or accessing information, or right after transferring data. Doing so can cause data to be corrupted or lost or cause damage to the external storage or device. Samsung is not responsible for losses, including loss of data, resulting from the misuse of external storage devices.

Formatting the memory card

A memory card formatted on a computer may not be compatible with the device. Format the memory card on the device.

Launch the **Settings** app and tap **Device care** → **Storage** → **Advanced** → **SD card** → **Format**.

- ⚠ Before formatting the memory card, remember to make backup copies of all important data stored in the memory card. The manufacturer's warranty does not cover loss of data resulting from user actions.

Turning the device on and off

- Follow all posted warnings and directions from authorized personnel in areas where the use of wireless devices is restricted, such as airplanes and hospitals.

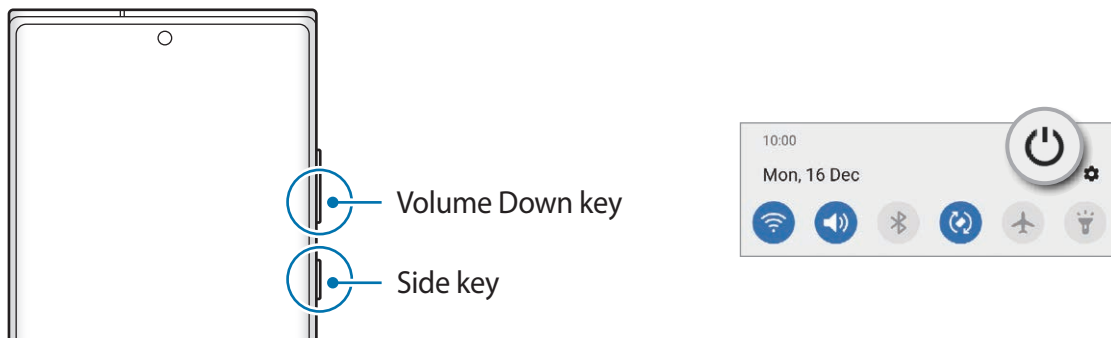

Turning the device on

Press and hold the Side key for a few seconds to turn on the device.

Turning the device off

- To turn off the device, press and hold the Side key and the Volume Down key simultaneously. Alternatively, open the notification panel and tap .
- Tap **Power off**.
To restart the device, tap **Restart**.

- You can set the device to turn off when you press and hold the Side key. Launch the **Settings** app, tap **Advanced features** → **Side key**, and then tap **Power off menu** under **Press and hold**.

Forcing restart

If your device is frozen and unresponsive, press and hold the Side key and the Volume Down key simultaneously for more than 7 seconds to restart it.

Emergency mode

You can switch the device to emergency mode to reduce battery consumption. Some apps and functions will be restricted. In emergency mode, you can make an emergency call, send your current location information to others, sound an emergency alarm, and more.

To activate emergency mode, press and hold the Side key and the Volume Down key simultaneously, and then tap **Emergency mode**. Alternatively, open the notification panel and tap  → **Emergency mode**.

To deactivate emergency mode, tap  → **Turn off Emergency mode.**

 The usage time left shows the time remaining before the battery power runs out. Usage time left may vary depending on your device settings and operating conditions.

Initial setup

When you turn on your device for the first time or after performing a data reset, follow the on-screen instructions to set up your device.

 If you do not connect to a Wi-Fi network, you may not be able to set up some device features during the initial setup.

Samsung account

Your Samsung account is an integrated account service that allows you to use a variety of Samsung services provided by mobile devices, TVs, and the Samsung website.

To check the list of services that can be used with your Samsung account, visit account.samsung.com.

1 Launch the **Settings** app and tap **Accounts and backup** → **Accounts** → **Add account** → **Samsung account**.

Alternatively, launch the **Settings** app and tap .

2 If you already have a Samsung account, sign in to your Samsung account.

- If you want to sign in using your Google account, tap **Continue with Google**.
- If you do not have a Samsung account, tap **Create account**.

Finding your ID and resetting your password

If you forget your Samsung account ID or password, tap **Find ID** or **Reset password** on the Samsung account sign-in screen. You can find your ID or reset your password after you enter the required information.

Signing out of your Samsung account

When you sign out of your Samsung account, your data, such as contacts or events, will also be removed from your device.

- 1 Launch the **Settings** app and tap **Accounts and backup** → **Accounts**.
- 2 Tap **Samsung account** → **Personal info** →  → **Sign out**.
- 3 Tap **Sign out**, enter your Samsung account password, and then tap **OK**.

Transferring data from your previous device (Smart Switch)

You can use Smart Switch to transfer data from your previous device to your new device.



Launch the **Settings** app and tap **Accounts and backup** → **Smart Switch**.



- This feature may not be supported on some devices or computers.
- Limitations apply. Visit www.samsung.com/smartswitch for details. Samsung takes copyright seriously. Only transfer content that you own or have the right to transfer.

Transferring data using a USB cable

You can connect your previous device to your device with the USB cable to easily and quickly transfer data.

- 1 Connect your device and the previous device using your device's USB cable.
A USB connector may be needed depending on the previous device.
 - 2 When the app selection pop-up window appears, tap **Smart Switch** → **Receive data**.
 - 3 In the previous device, tap **Allow**.
If you do not have the app, download it from **Galaxy Store** or **Play Store**.
Your device will recognize the previous device and a list of data you can transfer will appear.
 - 4 Select an item to bring and tap **Transfer**.
-  Do not disconnect the USB cable from the device when you are transferring files. Doing so may cause data loss or device damage.
-  Transferring data increases the battery power consumption of your device. Ensure that your device is sufficiently charged before transferring data. If the battery power is low, data transfer may be interrupted.

Transferring data wirelessly

Transfer data from your previous device to your device wirelessly via Wi-Fi Direct.

- 1 On the previous device, launch **Smart Switch**.
If you do not have the app, download it from **Galaxy Store** or **Play Store**.
- 2 On your device, launch the **Settings** app and tap **Accounts and backup** → **Smart Switch**.
- 3 Place the devices near each other.
- 4 On the previous device, tap **Send data** → **Wireless**.
- 5 On the previous device, tap **Allow**.
- 6 On your device, select an item to bring and tap **Transfer**.

Backing up and restoring data using external storage

Transfer data using external storage, such as a microSD card.

- 1 Back up data from your previous device to external storage.
- 2 Insert or connect the external storage device to your device.
- 3 On your device, launch the **Settings** app and tap **Accounts and backup** → **Smart Switch** →  → **Restore**.
- 4 Follow the on-screen instructions to transfer data from external storage.

Transferring backup data from a computer

Transfer data between your device and a computer. You must download the Smart Switch computer version app from www.samsung.com/smartswitch. Back up data from your previous device to a computer and import the data to your device.

- 1 On the computer, visit www.samsung.com/smartswitch to download Smart Switch.
- 2 On the computer, launch Smart Switch.
 If your previous device is not a Samsung device, back up data to a computer using a program provided by the device's manufacturer. Then, skip to the fifth step.
- 3 Connect your previous device to the computer using the device's USB cable.
- 4 On the computer, follow the on-screen instructions to back up data from the device. Then, disconnect your previous device from the computer.
- 5 Connect your device to the computer using the USB cable.
- 6 On the computer, follow the on-screen instructions to transfer data to your device.

Understanding the screen

Controlling the touchscreen

Tapping

Tap the screen.

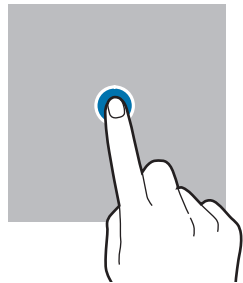

Tapping and holding

Tap and hold the screen for approximately 2 seconds.

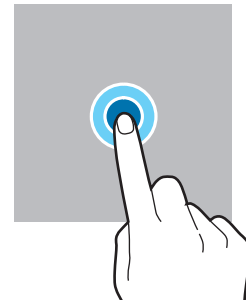

Dragging

Tap and hold an item and drag it to the target position.

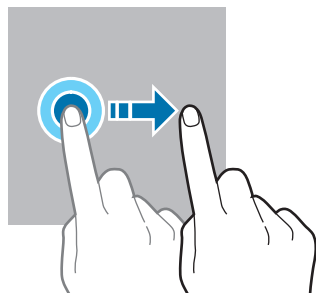

Double-tapping

Double-tap the screen.

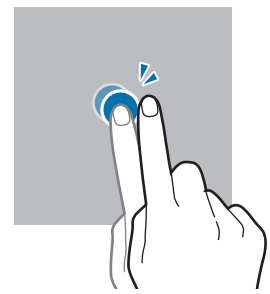

Swiping

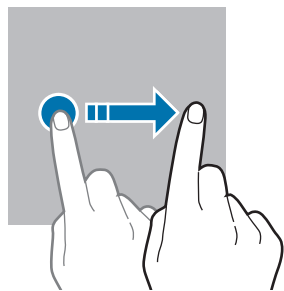

Swipe upwards, downwards, to the left, or to the right.

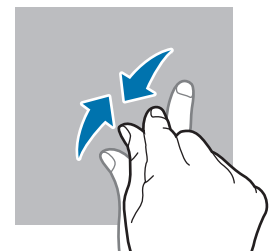
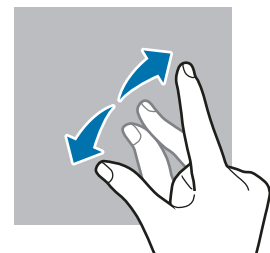

Spreading and pinching

Spread two fingers apart or pinch on the screen.



- 
 - Do not allow the touchscreen to come into contact with other electrical devices. Electrostatic discharges can cause the touchscreen to malfunction.
 - To avoid damaging the touchscreen, do not tap it with anything sharp or apply excessive pressure to it with your fingertips.
 - It is not recommended to use fixed graphics on part or all of the touchscreen for extended periods. Doing so may result in afterimages (screen burn-in) or ghosting.
- 
 - The device may not recognize touch inputs close to the edges of the screen, which are outside of the touch input area.

Navigation bar (soft buttons)

When you turn on the screen, the soft buttons will appear on the navigation bar at the bottom of the screen. The soft buttons are set to the Recents button, Home button, and Back button by default. The functions of the buttons can change according to the app currently being used or usage environment.

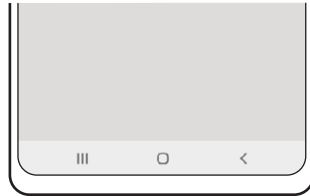

Button	Function
	Recents <ul style="list-style-type: none"> • Tap to open the list of recent apps.
○	Home <ul style="list-style-type: none"> • Tap to return to the Home screen. • Tap and hold to launch the Google Assistant app.
<	Back <ul style="list-style-type: none"> • Tap to return to the previous screen.

Hiding the navigation bar

View files or use apps on a wider screen by hiding the navigation bar.

Launch the **Settings** app, tap **Display** → **Navigation bar**, and then tap **Full screen gestures** under **Navigation type**. The navigation bar will be hidden and the gesture hints will appear. Tap **More options** and select an option you want.



Swipe from bottom



Swipe from sides and bottom

If you want to hide the gesture hints at the bottom of the screen, tap the **Gesture hints** switch to deactivate it.

Home screen and Apps screen

The Home screen is the starting point for accessing all of the device's features. It displays widgets, shortcuts to apps, and more.

The Apps screen displays icons for all apps, including newly installed apps.

Switching between Home and Apps screens

On the Home screen, swipe upwards or downwards to open the Apps screen.

To return to the Home screen, swipe upwards or downwards on the Apps screen.

Alternatively, tap the Home button or the Back button.

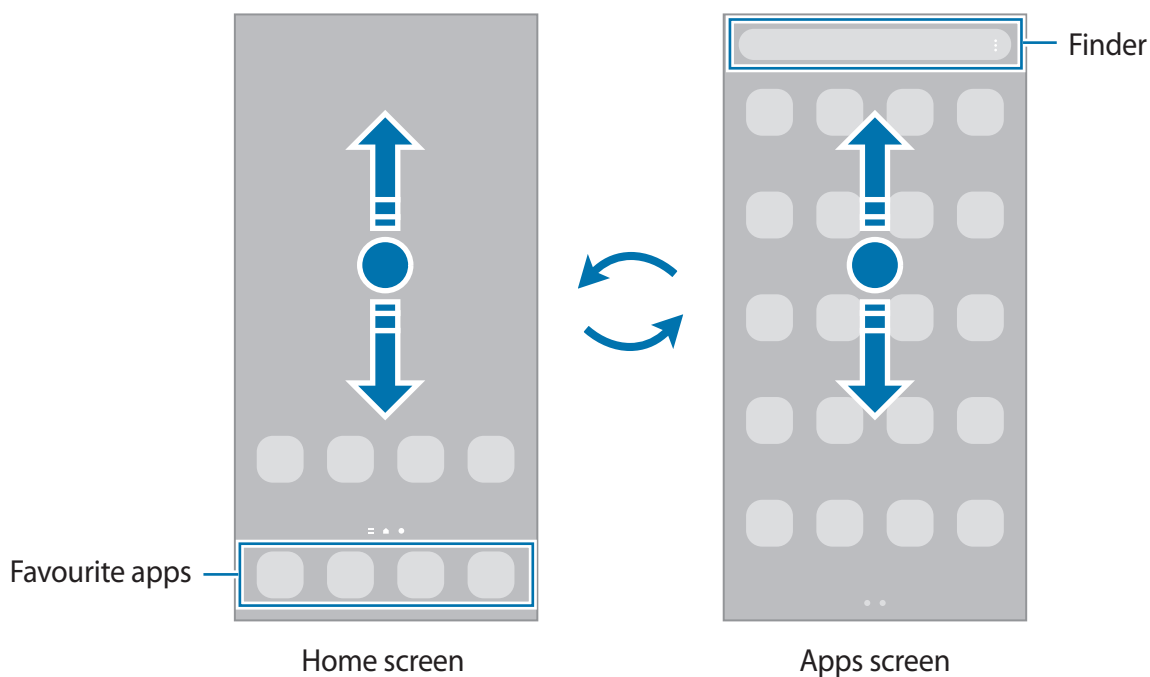



If you add the Apps button on the Home screen, you can open the Apps screen by tapping the button. On the Home screen, tap and hold an empty area, tap **Home screen settings**, and then tap the **Apps button** switch to activate it. The Apps button will be added at the bottom of the Home screen.



Editing the Home screen

On the Home screen, tap and hold an empty area or pinch your fingers together to access the editing options. You can set the wallpaper, add widgets, and more. You can also add, delete, or rearrange Home screen panels.

- Adding panels: Swipe to the left, and then tap .
- Moving panels: Tap and hold a panel preview, and then drag it to a new location.
- Deleting panels: Tap  on the panel.

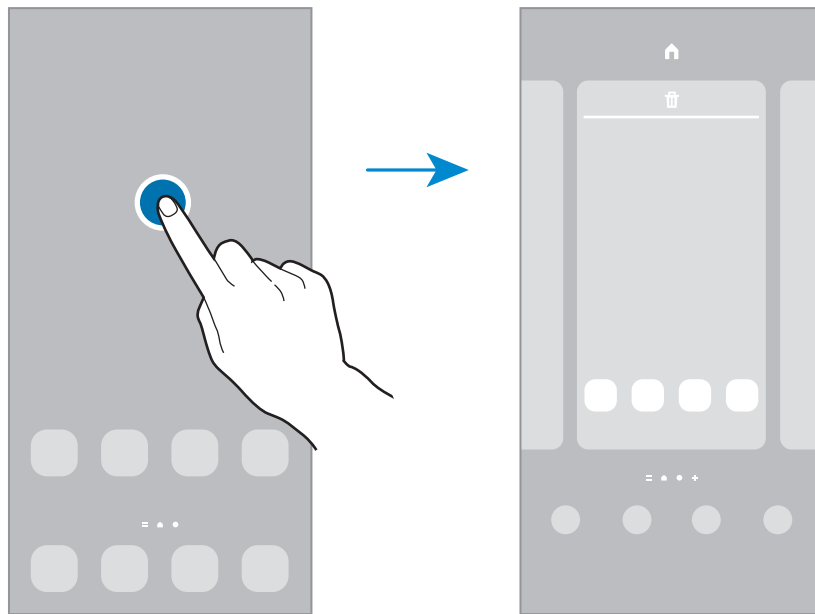

- **Wallpapers:** Change the wallpaper settings for the Home screen and the locked screen.
- **Themes:** Change the device's theme. Visual elements of interface, such as colours, icons, and wallpapers, will change depending on the selected theme.
- **Widgets:** Widgets are small apps that launch specific app functions to provide information and convenient access on your Home screen. Tap and hold a widget, and then drag it to the Home screen. The widget will be added on the Home screen.
- **Home screen settings:** Configure settings for the Home screen, such as the screen layout.

Displaying all apps on the Home screen

Without using a separate Apps screen, you can set the device to display all apps on the Home screen. On the Home screen, tap and hold an empty area, and then tap **Home screen settings** → **Home screen layout** → **Home screen only** → **Apply**.

You can now access all your apps by swiping to the left on the Home screen.

Launching Finder

Search for content on the device quickly.

- 1 On the Apps screen, tap **Search**. Alternatively, open the notification panel, swipe downwards, and then tap **Q**.
- 2 Enter a keyword.
Apps and content on your device will be searched.
If you tap **Q** on the keyboard, you can search for more content.

Moving items

Tap and hold an item, and then drag it to a new location. To move the item to another panel, drag it to the side of the screen.

To add a shortcut to an app on the Home screen, tap and hold an item on the Apps screen, and then tap **Add to Home**. A shortcut to the app will be added on the Home screen.

You can also move frequently used apps to the shortcuts area at the bottom of the Home screen.

Creating folders

Create folders and gather similar apps to quickly access and launch apps.

On the Home screen or the Apps screen, tap and hold an app, and then drag it over another app.

A new folder containing the selected apps will be created. Tap **Folder name** and enter a folder name.

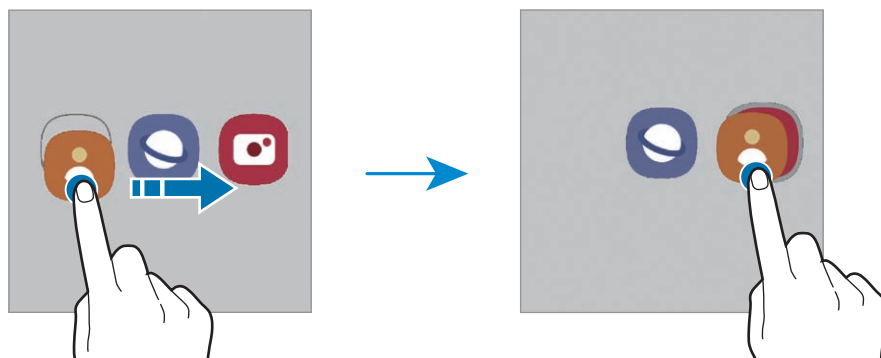

- **Adding more apps**

Tap **+** on the folder. Tick the apps to add and tap **Done**. You can also add an app by dragging it to the folder.

- **Moving apps from a folder**

Tap and hold an app to drag it to a new location.

- **Deleting a folder**

Tap and hold a folder, and then tap **Delete folder**. Only the folder will be deleted. The folder's apps will be relocated to the Apps screen.

Edge panel

You can quickly access your favourite apps and features from the Edge panels.

Drag the Edge panel handle towards the centre of the screen.

If the Edge panel handle is not visible, launch the **Settings** app, tap **Display** → **Edge screen**, and then tap the **Edge panels** switch to activate it.

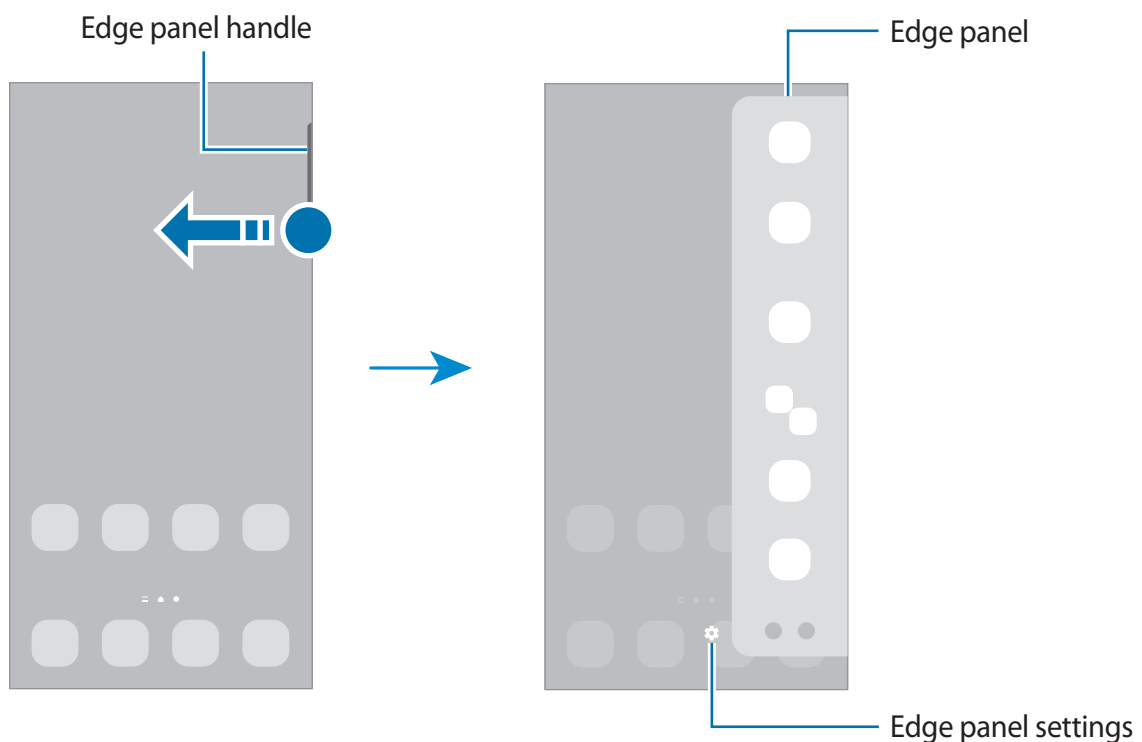

Lock screen

Pressing the Side key turns off the screen and locks it. Also, the screen turns off and automatically locks if the device is not used for a specified period.

To unlock the screen, swipe in any direction when the screen turns on.

If the screen is off, press the Side key to turn on the screen. Alternatively, double-tap the screen.

Changing the screen lock method









To change the screen lock method, launch the **Settings** app, tap **Lock screen** → **Screen lock type**, and then select a method.









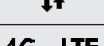



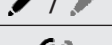

When you set a pattern, PIN, password, or your biometric data for the screen lock method, you can protect your personal information by preventing others from accessing your device. After setting the screen lock method, the device will require an unlock code whenever unlocking it.

 You can set your device to perform a factory data reset if you enter the unlock code incorrectly several times in a row and reach the attempt limit. Launch the **Settings** app, tap **Lock screen** → **Secure lock settings**, unlock the screen using the preset screen lock method, and then tap the **Auto factory reset** switch to activate it.

Indicator icons

Indicator icons appear on the status bar at the top of the screen. The icons listed in the table below are most common.

Icon	Meaning
	No signal
	Signal strength
	Roaming (outside of normal service area)
	GPRS network connected
	EDGE network connected
	UMTS network connected
	HSDPA network connected
	HSPA+ network connected
	LTE network connected

Icon	Meaning
	5G network connected
	LTE network connected in LTE network that includes the 5G network
	Wi-Fi connected
	Bluetooth feature activated
	S Pen connected/disconnected
	S Pen battery power level
	Location services being used
	Call in progress
	Missed call
	New text or multimedia message
	Alarm activated
	Mute mode / Vibration mode
	Flight mode activated
	Error occurred or caution required
	Battery charging / Battery power level



- The status bar may not appear at the top of the screen in some apps. To display the status bar, drag down from the top of the screen.
- Some indicator icons appear only when you open the notification panel.
- The indicator icons may appear differently depending on the service provider or model.

Notification panel

When you receive new notifications, indicator icons appear on the status bar. To see more information about the icons, open the notification panel and view the details.

To open the notification panel, drag the status bar downwards. To close the notification panel, swipe upwards on the screen.

You can use the following functions on the notification panel.

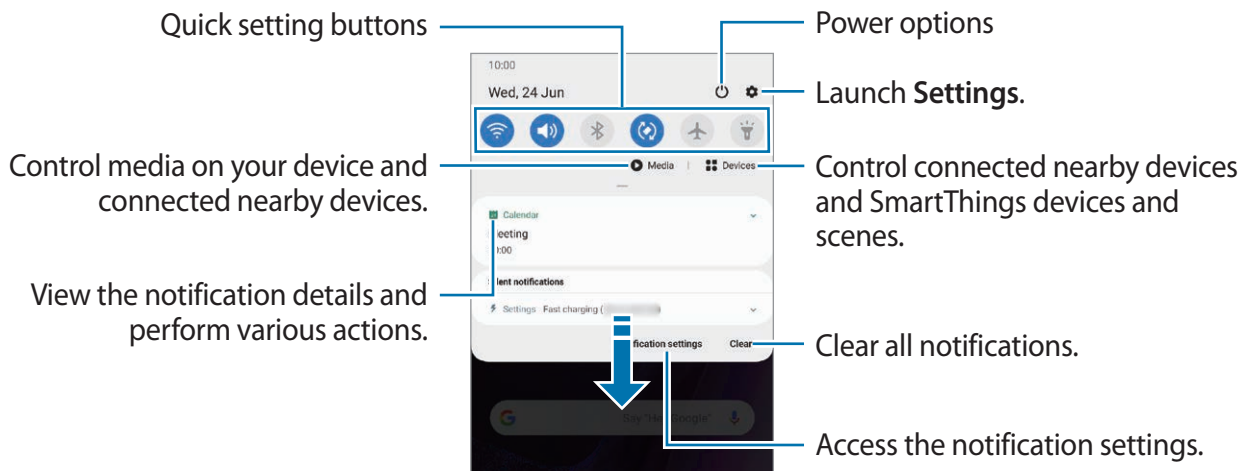

Using quick setting buttons

Tap quick setting buttons to activate certain features. Swipe downwards on the notification panel to view more buttons.

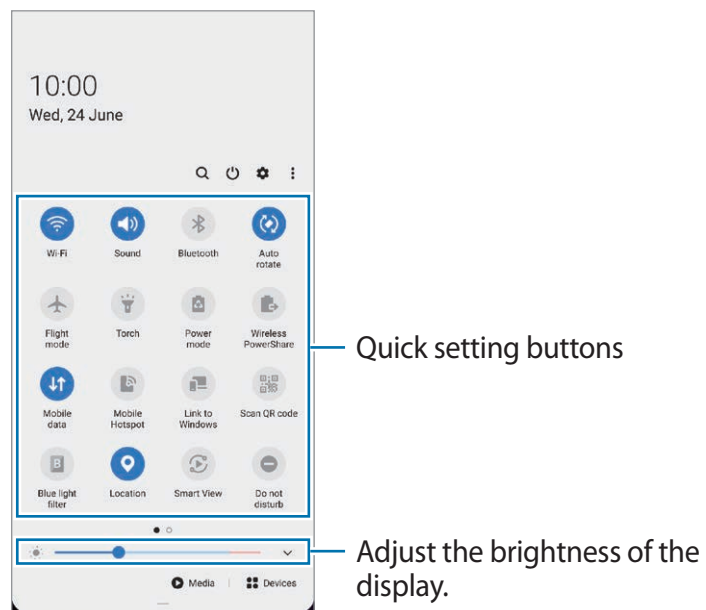

To change feature settings, tap the text under each button. To view more detailed settings, tap and hold a button.

To rearrange buttons, tap  → **Button order**, tap and hold a button, and then drag it to another location.

Controlling media playback

Take control of music or video playback easily using the Media feature. You can also continue playback on another device.

- 1 Open the notification panel and tap **Media**.
- 2 Tap the icons on the controller to control the playback.
To continue playback on another device, tap  and select the device you want.

Controlling nearby devices

Launch quickly and take control of nearby connected devices and frequently used SmartThings devices and scenes on the notification panel.

- 1 Open the notification panel and tap **Devices**.
Nearby connected devices and SmartThings devices and scenes will appear.
- 2 Select a nearby device or a SmartThings device to control it, or select a scene to launch it.

Viewing notifications via the pop-up window

When you receive a notification with edge lighting, you can quickly view its content and perform available actions by opening the pop-up window. For example, if you receive a message while watching a video or playing a game, you can view the message and reply to it without switching the screen.

When you receive a notification with edge lighting while using an app, drag the notification downwards.

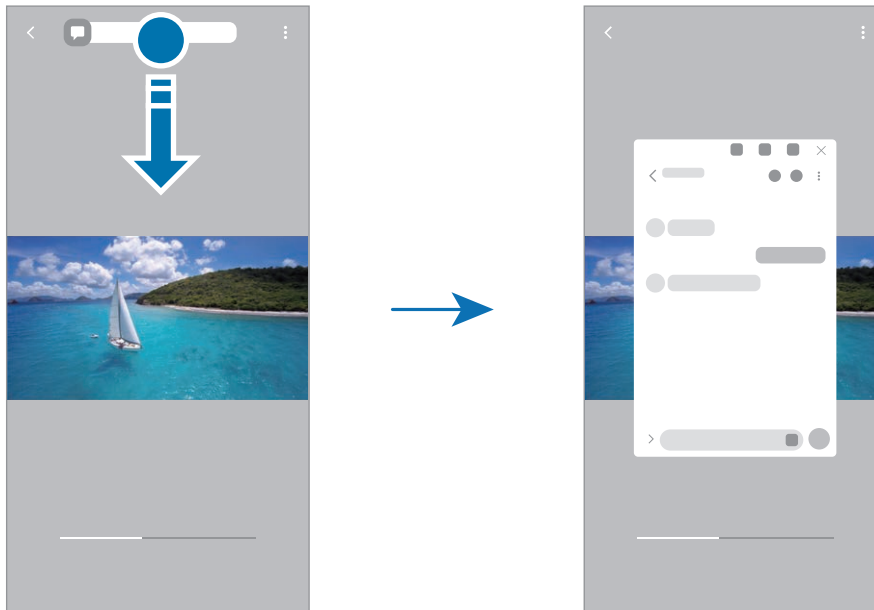

This feature is only available to apps that support the Multi window and edge lighting features. To view supported apps, launch the **Settings** app, tap **Display** → **Edge screen** → **Edge lighting** → **Choose apps**.

Screen capture and screen record

Screen capture

Capture a screenshot while using the device and write on, draw on, crop, or share the captured screen. You can capture the current screen and scrollable area.

How to capture a screenshot

Use the following methods to capture a screenshot. You can view the captured screenshots in **Gallery**.

Method 1) Key capture: Press the Side key and the Volume Down key simultaneously.





Method 2) Swipe capture: Swipe your hand to the left or right across the screen.

Method 3) Air command capture: Detach the S Pen from the slot to open the Air command panel, and then tap **Screen write**. Refer to [Screen write](#) for more information.

-  • It is not possible to capture a screenshot while using some apps and features.
- If capturing a screenshot by swiping is not activated, launch the **Settings** app, tap **Advanced features** → **Motions and gestures**, and then tap the **Palm swipe to capture** switch to activate it.







After capturing a screenshot, use the following options on the toolbar at the bottom of the screen:



- : Capture the current content and the hidden content on an elongated page, such as a webpage. When you tap  the screen will automatically scroll down and more content will be captured.
 - : Write or draw on the screenshot or crop a portion from the screenshot. You can view the cropped area in **Gallery**.
 - **#**: Add tags to the screenshot. To search for screenshots by tag, tap **Search** at the top of the Apps screen. You can view the tags list and easily search for the screenshot you want.
 - : Share the screenshot with others.
-  If the options are not visible on the captured screen, launch the **Settings** app, tap **Advanced features** → **Screenshots and screen recorder**, and then tap the **Screenshot toolbar** switch to activate it.

Screen record

Record the screen while using your device.

- 1 Open the notification panel, swipe downwards, and then tap  (**Screen recorder**) to activate it.
 - 2 Select a sound setting and tap **Start recording**.
After a countdown, recording will start.
 - To write or draw on the screen, tap .
 - To show the S Pen pointer on the screen, tap . You can use this feature only when the S Pen is detached from the device.
 - To record the screen with a video overlay of yourself, tap .
 - 3 When you are finished recording the video, tap .
You can view the video in **Gallery**.
-  To change the screen recorder settings, launch the **Settings** app and tap **Advanced features** → **Screenshots and screen recorder** → **Screen recorder settings**.

Entering text

Keyboard layout

A keyboard appears automatically when you enter text.

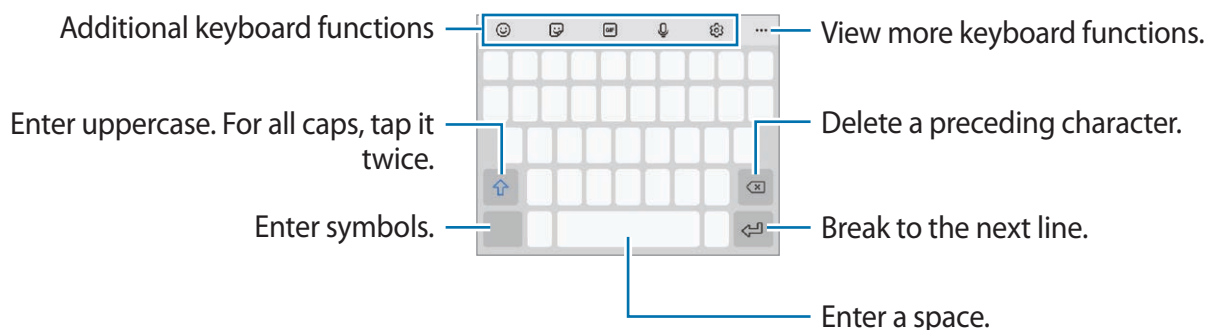

-  Text entry is not supported in some languages. To enter text, you must change the input language to one of the supported languages.



Changing the input language

Tap  → **Languages and types** → **Manage input languages** and select the languages to use. When you select two or more languages, you can switch between the input languages by swiping to the left or right on the space key.





Changing the keyboard

On the navigation bar, tap  to change the keyboard.











To change the keyboard type, tap  → **Languages and types**, select a language, and then select the keyboard type you want.

-  • If the keyboard button () does not appear on the navigation bar, launch the **Settings** app, tap **General management** → **Language and input** → **On-screen keyboard**, and then tap the **Show Keyboard button** switch to activate it.
- On a **3 x 4 keyboard**, a key has three or four characters. To enter a character, tap the corresponding key repeatedly until the desired character appears.

Additional keyboard functions



- : Enter emoticons.
- : Enter stickers. You can also enter your emoji stickers that look like you. Refer to [Using your emoji stickers in chats](#) for more information.
- : Attach animated GIFs.
- : Enter text by voice.
- : Change the keyboard settings.

Tap  to use more keyboard functions.

- : Switch to handwriting mode.
- : Search for content and enter it.
- : Translate text and enter it.
- : Enter your personal information registered to Samsung Pass.
- : Share video links.
- : Add an item from the clipboard.
- : Open the text editing panel.
- : Change the keyboard mode.
- : Change the keyboard size.
- : Enter stickers.

 Some features may not be available depending on the region or service provider.

Copying and pasting

- 1 Tap and hold over text.
- 2 Drag  or  to select the desired text, or tap **Select all** to select all text.
- 3 Tap **Copy** or **Cut**.
The selected text is copied to the clipboard.
- 4 Tap and hold where the text is to be inserted and tap **Paste**.
To paste text that you have previously copied, tap **Clipboard** and select the text.

Apps and features

Installing or uninstalling apps

Galaxy Store

Purchase and download apps. You can download apps that are specialized for Samsung Galaxy devices.

Launch the **Galaxy Store** app. Browse apps by category or tap **Q** to search for a keyword.

-  • This app may not be available depending on the region or service provider.
- To change the auto update settings, tap **≡** → **⚙** → **Auto update apps**, and then select an option.

Play Store

Purchase and download apps.

Launch the **Play Store** app. Browse apps by category or search for apps by keyword.

-  To change the auto update settings, tap **≡** → **Settings** → **Auto-update apps**, and then select an option.

Managing apps

Uninstalling or disabling apps

Tap and hold an app and select an option.

- **Uninstall:** Uninstall downloaded apps.
- **Disable:** Disable selected default apps that cannot be uninstalled from the device.

-  Some apps may not support this feature.

Enabling apps

Launch the **Settings** app, tap **Apps** → ▼ → **Disabled**, select an app, and then tap **Enable**.

Setting app permissions

For some apps to operate properly, they may need permission to access or use information on your device.

To view your app permission settings, launch the **Settings** app and tap **Apps**. Select an app and tap **Permissions**. You can view the app's permissions list and change its permissions.

To view or change app permission settings by permission category, launch the **Settings** app and tap **Apps** → ⋮ → **Permission manager**. Select an item and select an app.

 If you do not grant permissions to apps, the basic features of the apps may not function properly.

S Pen

Using the S Pen

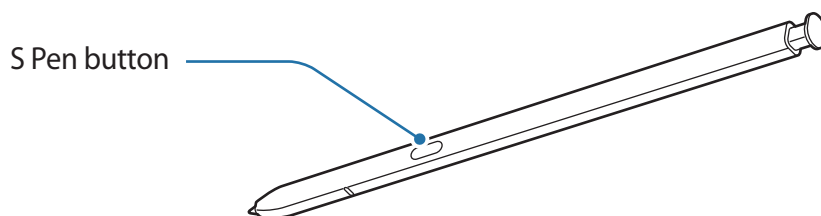

- ⚠ • Do not bend or apply excessive pressure with the S Pen while using it. The S Pen may be damaged or the nib may be deformed.
- Do not hard press on the screen with the S Pen. The pen nib may be deformed.
-  • If there is a magnet near the device, some S Pen actions, such as charging or tapping the touchscreen, may not work.
- Even if the S Pen has been fully discharged, you can use some S Pen features, such as tapping the touchscreen or the Air command features.
- If you use the S Pen at sharp angles on the screen, the device may not recognize the S Pen actions.
- If water enters the S Pen slot, gently shake the device to remove the water from the slot before using it.
- If the S Pen is not working properly, take it to a Samsung Service Centre.

Detaching the S Pen

Press the end of the S Pen to disengage it. Then, pull the S Pen from the slot. To store the S Pen, reinsert it into the slot and push it until it clicks into place.

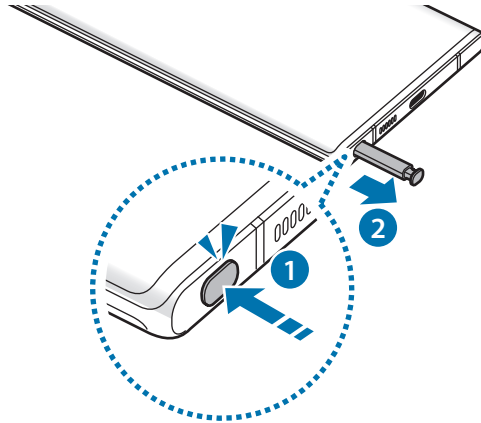

Charging the S Pen



The S Pen must be charged before you can control apps remotely by using the S Pen button. When you insert the S Pen into the slot, charging will start.

If the Air action feature is deactivated, the S Pen will be charged only when the device is charging.

Air actions

Control apps remotely using the S Pen connected to your device via Bluetooth Low Energy (BLE).

For example, you can quickly launch apps, such as the camera app, by pressing and holding the S Pen button. Also, while using the camera app, you can take a photo by pressing the button once. While playing music, you can turn the volume up if you lift the S Pen up while pressing and holding the S Pen button and turn the volume down if you lower it.

- 📌 • The S Pen must be charged before you can use the Air actions feature. Refer to [Charging the S Pen](#) for more information.
- When you detach the S Pen from the slot, the  icon will appear on the status bar. If the S Pen is discharged or far from the device, or if there are obstacles or there is external interference between the S Pen and the device, the S Pen will be disconnected from the device and the icon will turn grey (). To use the Air actions feature again, connect the S Pen with the device by reinserting the S Pen into the slot.

Taking photos with the S Pen

You can take photos with your device placed at a distance without setting a timer by pressing the S Pen button.

- 1 Launch the **Settings** app, tap **Advanced features** → **S Pen** → **Air actions**, and then tap the switch to activate the feature.
- 2 Launch the **Camera** app.
- 3 Press the S Pen button once to take a photo.
 - To take a series of photos, press and hold the S Pen button.
 - To change the shooting mode, move the S Pen to the left or right while pressing and holding the S Pen button.
 - To switch between cameras, press the S Pen button twice.

Changing apps or features to use

Change the app, feature, or actions you want to use with the S Pen feature. Launch the **Settings** app, tap **Advanced features** → **S Pen** → **Air actions**.

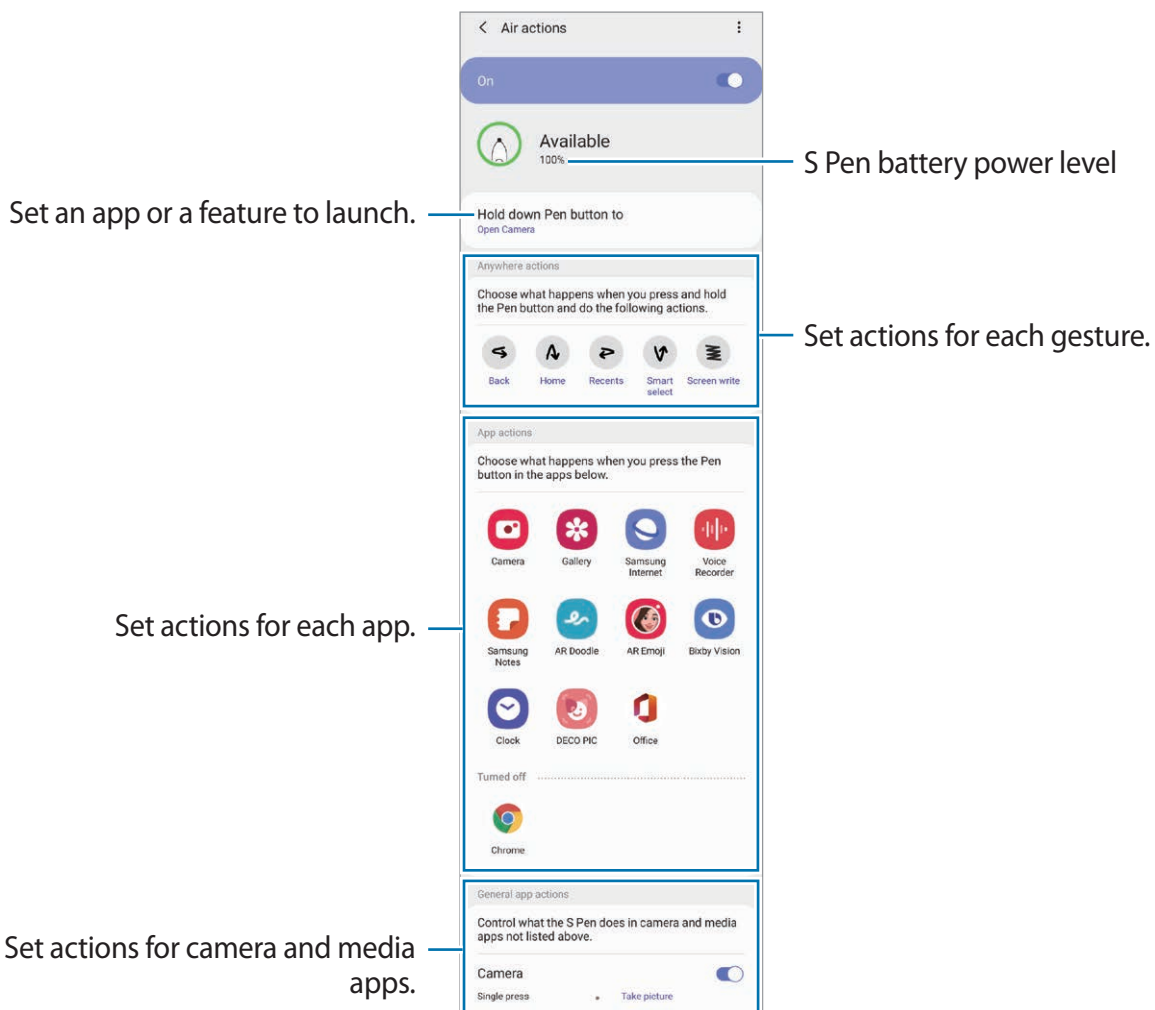

Connecting another S Pen

Before using S Pen features with another S Pen, such as Air actions, you must connect the S Pen to your device.

- 1 Insert another S Pen into the slot.
- 2 Open the notification panel, swipe downwards, tap  (S Pen air actions), and then tap again to reactivate it.
- 3 Tap **Connect new S Pen**.

The S Pen will be connected. You may experience a brief delay before it finishes connecting.

-  • You can only connect Samsung-approved S Pens that support Bluetooth Low Energy (BLE).
- Do not detach the S Pen from the device when it is being connected. Doing so will interrupt the process.
- If it fails to connect or you want to use the previous S Pen, reconnect it with the method shown above.

Resetting your S Pen

If the S Pen has connection problems or the S Pen disconnects often, reset the S Pen and connect it again.

Insert the S Pen into the slot. Then, open the Air actions setting screen and tap  → **Reset S Pen**.

Air command

Air command is a menu that provides S Pen features and quick access to frequently used apps.

To open the Air command panel, detach the S Pen from the slot or hover the S Pen over the screen and press the S Pen button. You can also tap the Air command icon (🖋️) with the S Pen.

Drag upwards or downwards on the Air command panel and select a function or app you want.

- 📌 When the screen is off or locked with a screen lock method, removing the S Pen will not open the Air command panel.

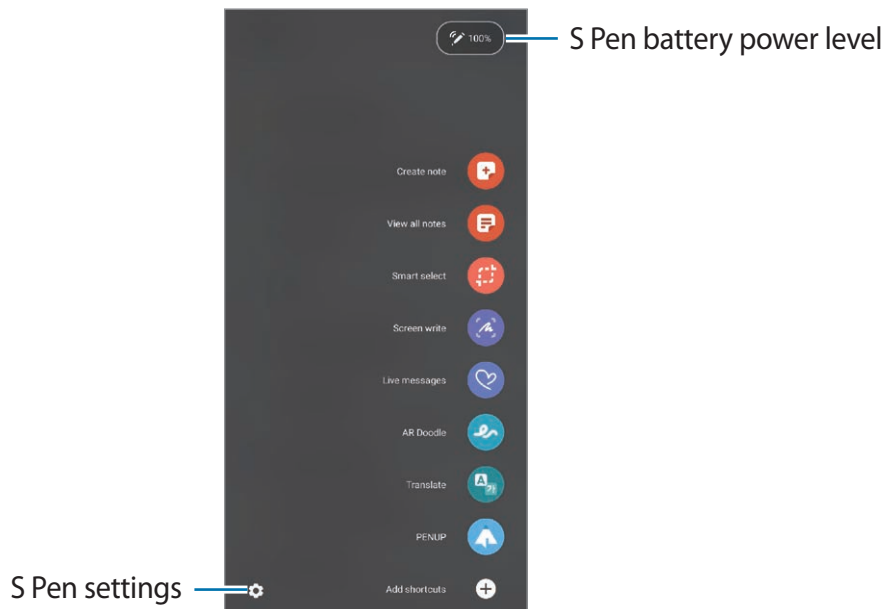

- **Create note:** Create notes easily in a pop-up window. You can also launch this feature by double-tapping the screen while pressing and holding the S Pen button. Refer to [Samsung Notes](#) for more information.
- **View all notes:** View all notes in the **Samsung Notes** app.
- **Smart select:** Use the S Pen to select an area and perform actions, such as sharing or saving. Refer to [Smart select](#) for more information.
- **Screen write:** Capture screenshots to write or draw on them or crop an area from the captured image. You can also capture the current content and the hidden content on an elongated page, such as a webpage. Refer to [Screen write](#) for more information.
- **Live messages:** Instead of sending a text message, create and send a unique message by recording your actions while handwriting or drawing a live message and saving it as an animated file. Refer to [Live messages](#) for more information.

- **AR Doodle:** Record fun videos with virtual handwriting or drawings on faces or anywhere else. Refer to [AR Doodle](#) for more information.
- **Translate:** Hover the S Pen over a word to translate it. Refer to [Translate](#) for more information.
- **PENUP:** Post your artwork, view others' artwork, and get useful drawing tips. Refer to [PENUP](#) for more information.
- **Bixby Vision:** Use the Bixby Vision features to search for similar images, detect and translate text, and more. Refer to [Bixby Vision](#) for more information.
- **Magnify:** Hover the S Pen over an area of the screen to enlarge it.
- **Glance:** Reduce an app to a thumbnail and hover the S Pen over the thumbnail to open the app in full screen view. Refer to [Glance](#) for more information.
- **Colouring:** Add colours to images provided by PENUP using the S Pen.
- **Write on calendar:** Launch the **Calendar** app and write or draw on the screen. Refer to [Write on calendar](#) for more information.
- **Add shortcuts:** Add shortcuts to frequently used apps to the Air command panel.

Air command icon

When the Air command panel is closed, the Air command icon will remain on the screen. You can open the Air command panel by tapping the icon with the S Pen.

To move the icon, drag  to a new location.

To remove the icon, drag  to **Remove** at the top of the screen.

If the Air command icon does not appear on the screen, launch the **Settings** app, tap **Advanced features** → **S Pen**, and then tap the **Show floating icon** switch to activate it.





While using apps that support the Air actions feature, you can view actions available with each app by hovering the S Pen over the Air command icon.

Smart select

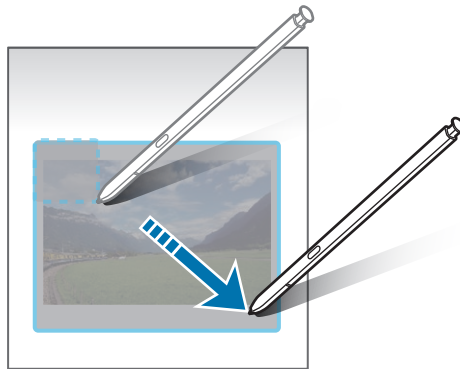
Use the S Pen to select an area and perform actions, such as sharing or saving. You can also select an area from a video and capture it as a GIF animation.

- 1 When there is content you want to capture, such as a part of an image, open the Air command panel and tap **Smart select**.
- 2 Select a desired shape icon on the toolbar and drag the S Pen across the content you want to select.



- 3 Select an option to use with the selected area.
 - **Extract text:** Extract text from the selected area.
 - **Pin to screen:** Pin the selected area to the screen.
 - : Automatically changes the appearance of the selected area.
 - : Write or draw on the selected area.
 - : Share the selected area with others.
 - : Save the selected area in **Gallery**.

Capturing an area from a video

While playing a video, select an area and capture it as a GIF animation.

- 1 When there is content you want to capture during video playback, open the Air command panel and tap **Smart select**.
- 2 On the toolbar, tap .

3 Adjust the position and size of the capturing area.

Adjust the position.

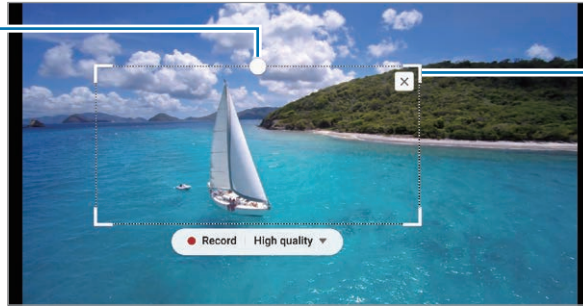

Drag a corner of the frame to resize.





4 Tap **Record** to start capturing.



- Before capturing a video, make sure that the video is playing.
- The maximum duration you can capture an area of the video for will be displayed on the screen.
- When capturing an area from a video, its sound will not be recorded.

5 Tap **Stop** to stop capturing.

6 Select an option to use with the selected area.

- : Write or draw on the selected area. Tap  to view the result before saving the file.
- : Share the selected area with others.
- : Save the selected area in **Gallery**.

Screen write

Capture screenshots to write or draw on them or crop an area from the captured image.

1 When there is content you want to capture, open the Air command panel and tap **Screen write**.

The current screen is automatically captured and the editing toolbar appears.

2 Write a memo on the screenshot.

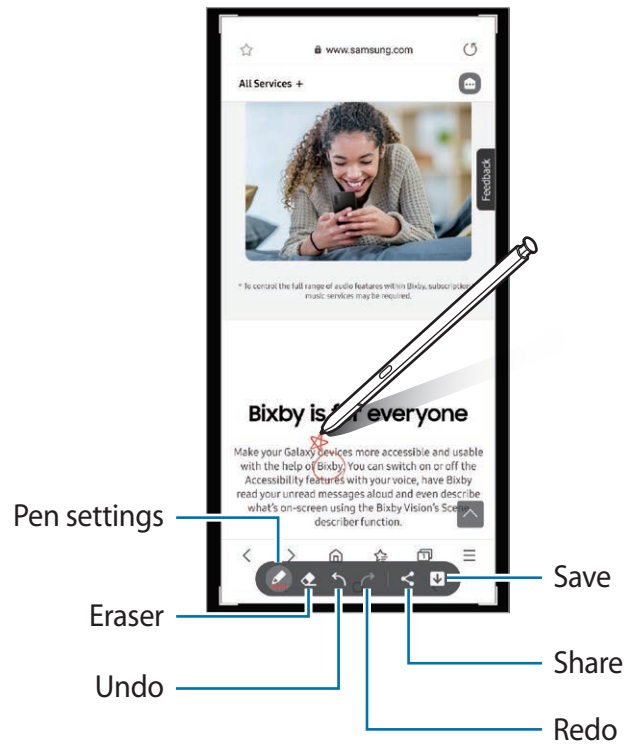

3 Share or save the screenshot.

You can view the captured screenshots in **Gallery**.

 It is not possible to capture a screenshot while using some apps.

Live messages

Instead of a text message, create and send a unique message by recording your actions while handwriting or drawing a live message and saving it as an animated file.

- 1 When you want to send an animated message, open the Air command panel and tap **Live messages**.
- 2 Customize the background image and tap **Done** or **Start drawing**.
- 3 Write or draw on the live message screen.

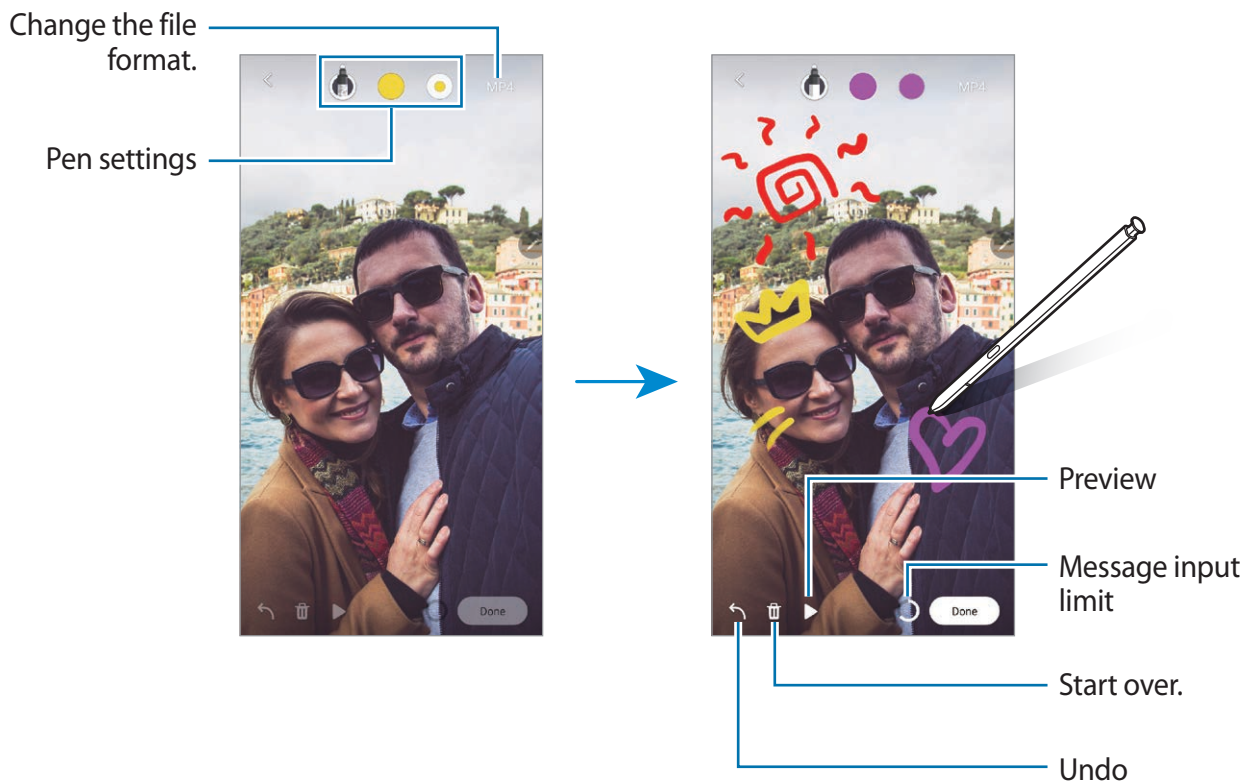

- 4 Tap **Done**.
The live message will be saved in **Gallery** as an animated GIF file or a video.
- 5 Tap **Share** and select a method.

Translate

Hover the S Pen over the text you want to translate. The units included in the text will also be converted.

- 1 When there is text you want to translate, open the Air command panel and tap **Translate**.
- 2 Select the languages on the translator panel at the top of the screen. You can change the text between words and sentences by tapping **T** or **☰**.
- 3 Hover the S Pen over the text you want to translate or the unit you want to convert. The translated text will appear. To listen to the pronunciation of the original text, tap **🔊**. The **🔊** icon may not appear depending on the language you select.

Select languages.

Text selecting granularity (word or sentence)

Translation result

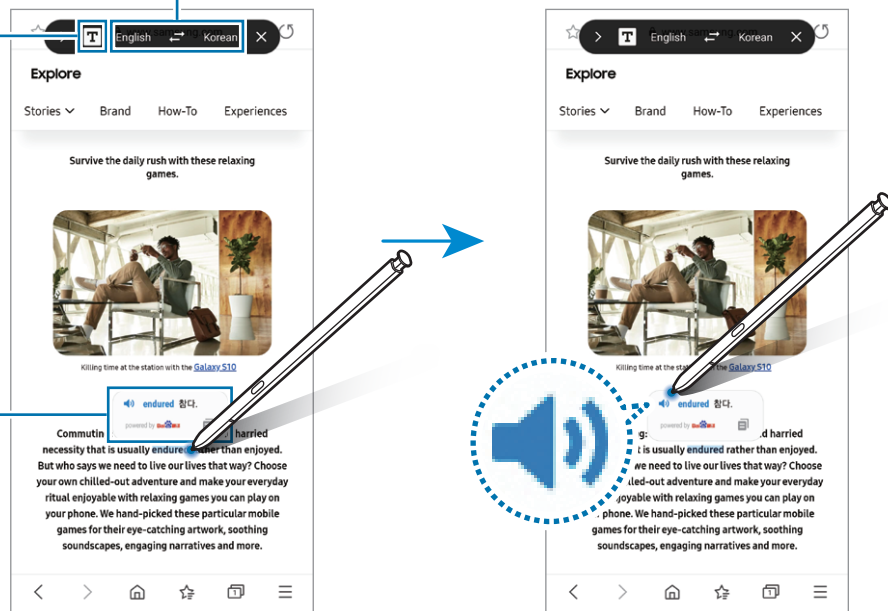

- This feature does not support some languages.
- This feature is available only when detectable text is on the screen.

Bixby Vision

When you hover the S Pen over the content, the content is recognized and available search icons will appear. Use the features to search for similar images, detect and translate text, and more. Refer to [Bixby Vision](#) for more information.

- 1 When there is an image you want to search for relevant information or extract text from, open the Air command panel and tap **Bixby Vision**.
- 2 Hover the S Pen over the content you want. When the available options appear on the screen, select an option you want.

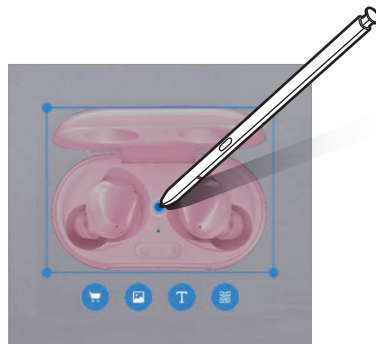

Glance

Reduce an app to a thumbnail and hover the S Pen over the thumbnail to open the app in full screen view.

For example, launch a map app, open the Air command panel, and then tap **Glance**. The app will be reduced to a thumbnail at the bottom of the screen. While browsing webpages, hover the S Pen over the thumbnail to open the map app on the full screen and quickly search for places.

Hover the S Pen away from the screen to reduce the app to a thumbnail again.

To close the minimized app, tap and hold the thumbnail and drag it to **Remove** at the top of the screen.

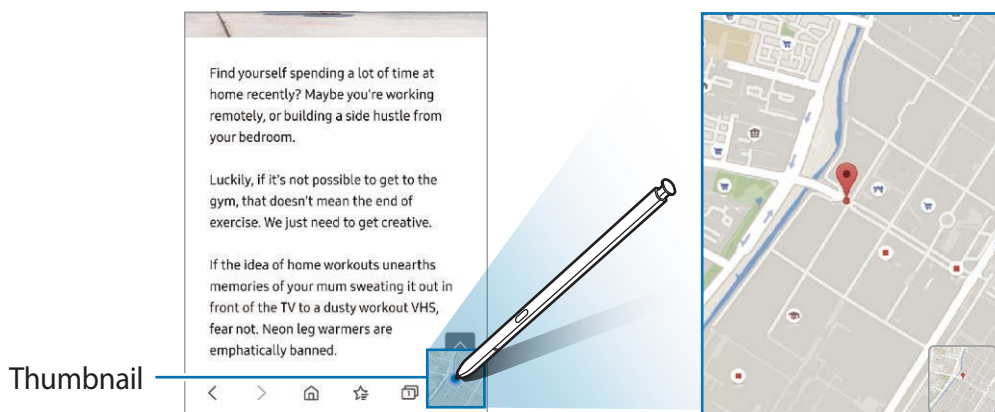

Write on calendar

Fill in your plans easily and quickly by writing or drawing on the calendar screen.

Open the Air command panel, tap **Write on calendar**, and then fill in your plans on the calendar. When you are finished, tap **Save**. To edit it, tap .

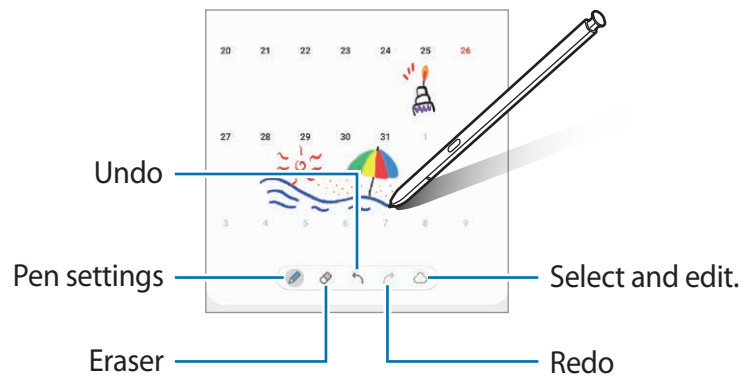

Air view

Hover the S Pen over an item on the screen to preview content or view information in a pop-up window.

In some apps, Action buttons will be displayed on the preview window.

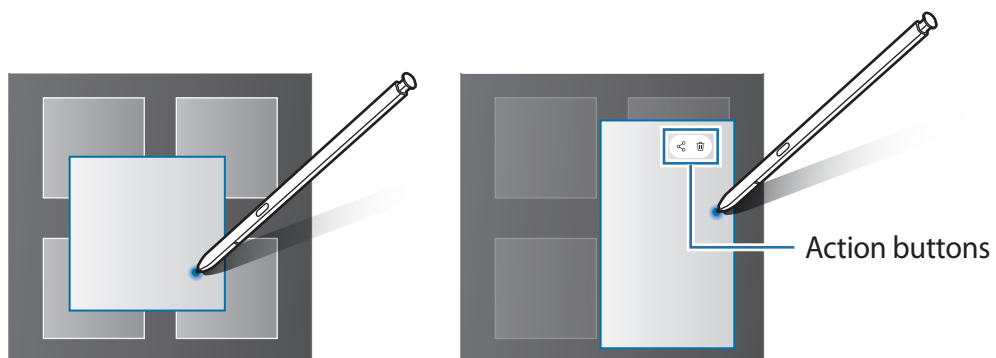

 If this feature is not activated, launch the **Settings** app, tap **Advanced features** → **S Pen**, and then tap the **Air view** switch to activate it.

Pen Select

While pressing and holding the S Pen button, drag the S Pen over text or item lists to select multiple items or text. You can also copy and paste the selected items or text into another app or share them with others.

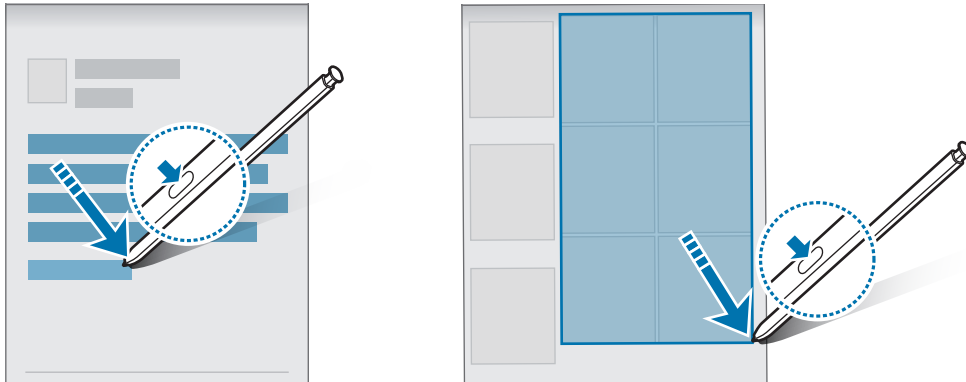

Screen off memo

You can quickly create memos by writing on the screen without turning it on.

When the screen is off, detach the S Pen or hover the S Pen over the screen and press the S Pen button.

When you tap **Save** or reinsert the S Pen into the slot after writing a memo, the memo will be saved to **Samsung Notes**.

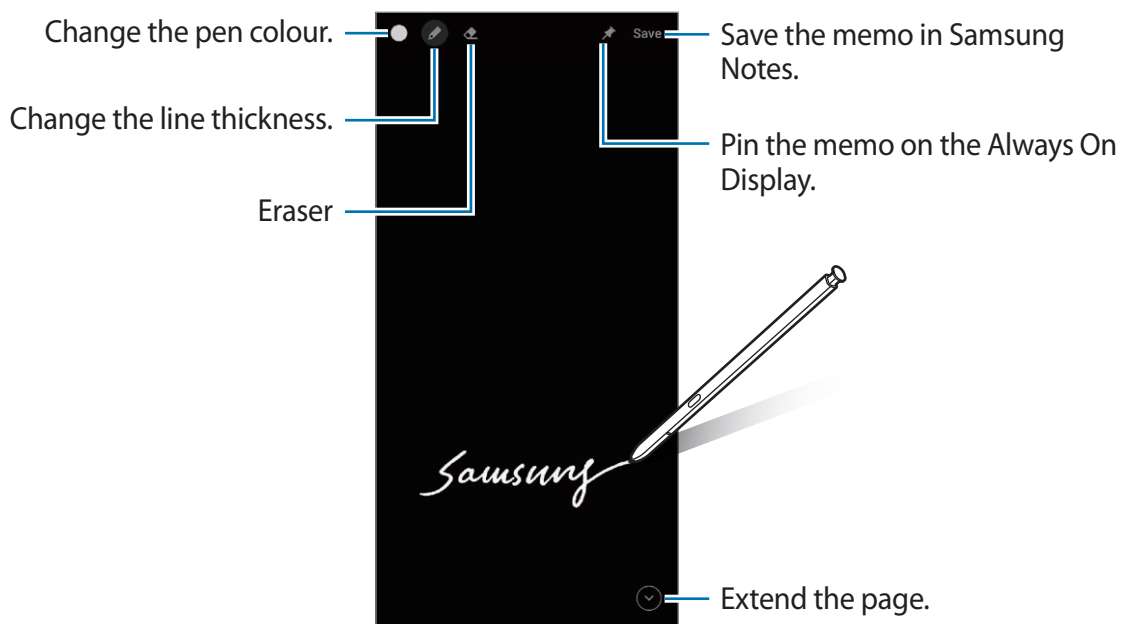



If this feature is not activated, launch the **Settings** app, tap **Advanced features** → **S Pen**, and then tap the **Screen off memo** switch to activate it.

Pinning a memo on the Always On Display

To pin a screen off memo on the Always On Display, tap  → **Pin to Always On Display**. The pinned memo will not be saved yet.

To edit the pinned memo, double-tap the memo. If you pin the edited memo on the Always On Display again, the original memo will be saved to **Samsung Notes**.

To minimize the pinned memo, double-tap . The memo will be displayed as the  icon on the Always On Display. To view the memo again, double-tap .

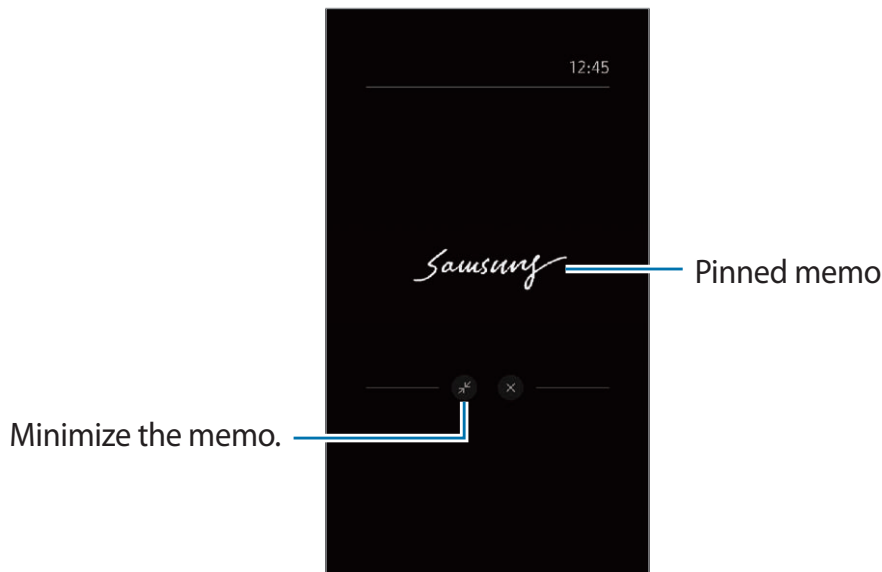

 If you do not perform any actions for a certain period after opening a memo, the memo will be automatically minimized.

Unlocking the screen using the S Pen

If the screen is locked while the S Pen is connected, you can unlock the screen by pressing the S Pen button.

1 Launch the **Settings** app and tap **Advanced features** → **S Pen** → **S Pen unlock**.

2 Tap **Use S Pen unlock** → **OK**.

Now you can unlock the screen by pressing the S Pen button.

-  • The **Use S Pen unlock** feature is available only when the screen lock method is set.
- To use this feature, the S Pen must be connected to your device.

Phone

Introduction

Make or answer voice calls.

-  If the area around the rear camera is covered, unwanted noises may incur during a call. Remove accessories, such as a screen protector or stickers, around the rear camera area.

Making calls

- 1 Launch the **Phone** app and tap **Keypad**.
- 2 Enter a phone number.
- 3 Tap  to make a voice call.

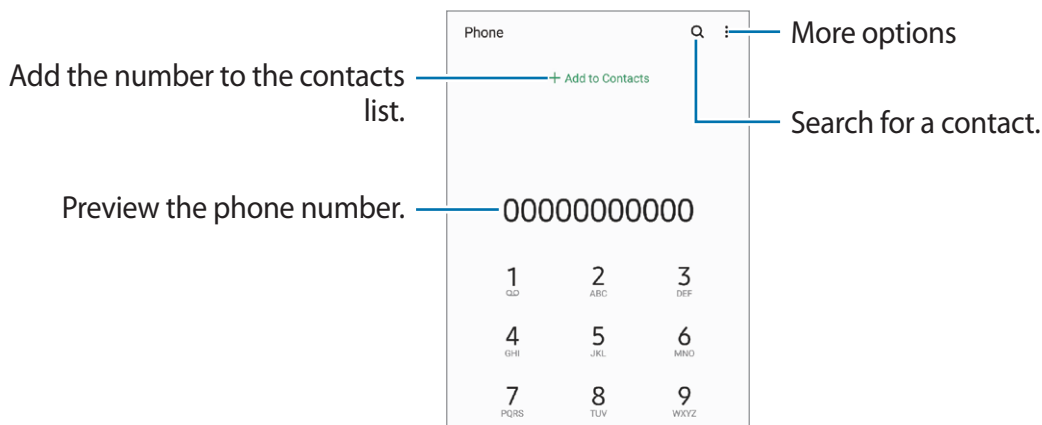

Making calls from call logs or contacts list

Launch the **Phone** app, tap **Recents** or **Contacts**, and then swipe to the right on a contact or a phone number to make a call.

If this feature is deactivated, launch the **Settings** app, tap **Advanced features** → **Motions and gestures**, and then tap the **Swipe to call or send messages** switch to activate it.

Using speed dial

To set a number to speed dial, launch the **Phone** app, tap **Keypad** or **Contacts** →  → **Speed dial numbers**, select a speed dial number, and then add a phone number.

To make a call, tap and hold a speed dial number on the keypad. For speed dial numbers 10 and up, tap the first digit(s) of the number, and then tap and hold the last digit.

For example, if you set the number **123** as a speed dial number, tap **1**, tap **2**, and then tap and hold **3**.

Making calls by searching for nearby places

Launch the **Phone** app, tap **Places**, and then select a category or tap **Q** and enter a business name in the search field. Or, select one from the recommended hot places. The business's information, such as its phone number or address, will appear.

 This feature may not be available depending on the region or service provider.

Making an international call

- 1 Launch the **Phone** app and tap **Keypad**.
- 2 Tap and hold **0** until the + sign appears.
- 3 Enter the country code, area code, and phone number, and then tap .

Receiving calls



Answering a call

When a call comes in, drag  outside the large circle.

Rejecting a call



When a call comes in, drag  outside the large circle.

To send a message when rejecting an incoming call, drag the **Send message** bar upwards and select a message to send.

To create various rejection messages, launch the **Phone** app, tap  → **Settings** → **Quick decline messages**, enter a message, and then tap .

Blocking phone numbers

Block calls from specific numbers added to your block list.

- 1 Launch the **Phone** app and tap  → **Settings** → **Block numbers**.
- 2 Tap **Recents** or **Contacts**, select contacts or phone numbers, and then tap **Done**.
To manually enter a number, tap **Add phone number**, enter a phone number, and then tap .

When blocked numbers try to contact you, you will not receive notifications. The calls will be logged in the call log.

-  You can also block incoming calls from people that do not show their caller ID. Tap the **Block unknown/hidden numbers** switch to activate the feature.

Options during calls

- **Add call:** Dial a second call. The first call will be put on hold. When you end the second call, the first call will be resumed.
- **Hold call:** Hold a call.
- **Bluetooth:** Switch to a Bluetooth headset if it is connected to the device.
- **Speaker:** Activate or deactivate the speakerphone. When using the speakerphone, keep the device away from your ears.
- **Mute:** Turn off the microphone so that the other party cannot hear you.
- **Keypad / Hide:** Open or close the keypad.
- : End the current call.

-  The features for calling may vary depending on the region or service provider.

Contacts

Introduction

Create new contacts or manage contacts on the device.

Adding contacts

Creating a new contact

- 1 Launch the **Contacts** app and tap .
- 2 Select a storage location.
- 3 Enter contact information and tap **Save**.

Importing contacts

Add contacts by importing them from other storages to your device.

- 1 Launch the **Contacts** app and tap  → **Manage contacts** → **Import or export contacts** → **Import**.
- 2 Follow the on-screen instructions to import contacts.

Syncing contacts with your web accounts





Sync your device contacts with online contacts saved in your web accounts, such as your Samsung account.

- 1 Launch the **Settings** app, tap **Accounts and backup** → **Accounts** and select the account to sync with.
- 2 Tap **Sync account** and tap the **Contacts** switch to activate it.
For the Samsung account, tap  → **Sync settings** and tap the **Contacts** switch to activate it.

Searching for contacts

Launch the **Contacts** app. Tap **Q** at the top of the contacts list and enter search criteria.

Tap the contact. Then take one of the following actions:

- : Add to favourite contacts.
- : Make a voice call.
- : Compose a message.
- : Compose an email.

Deleting contacts

1 Launch the **Contacts** app and tap  → **Delete**.

2 Select contacts and tap **Delete**.

To delete contacts one by one, tap a contact from the contacts list and tap  → **Delete**.

Sharing contacts

You can share contacts with others by using various sharing options.

1 Launch the **Contacts** app and tap  → **Share**.

2 Select contacts and tap **Share**.

3 Select a sharing method.

Creating groups

You can add groups, such as family or friends, and manage contacts by group.

1 Launch the **Contacts** app and tap  → **Groups** → **Create group**.

2 Follow the on-screen instructions to create a group.

Merging duplicate contacts

If your contacts list includes duplicate contacts, merge them into one to streamline your contacts list.

- 1 Launch the **Contacts** app and tap  → **Manage contacts** → **Merge contacts**.
- 2 Tick contacts and tap **Merge**.



Messages

Introduction

Send and view messages by conversation.

You may incur additional charges for sending or receiving messages when you are roaming.

Sending messages

- 1 Launch the **Messages** app and tap .
- 2 Add recipients and enter a message.
To record and send a voice message, tap and hold , say your message, and then release your finger. The recording icon appears only while the message input field is empty.
- 3 Tap  to send the message.

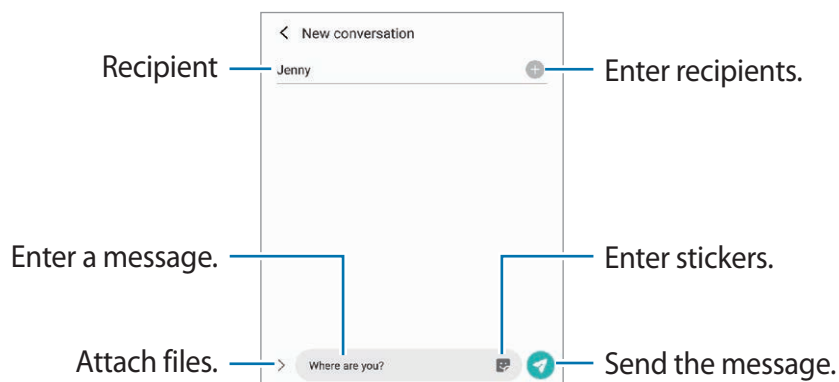

Viewing messages

- 1 Launch the **Messages** app and tap **Conversations**.
- 2 On the messages list, select a contact or a phone number.
 - To reply to the message, tap the message input field, enter a message, and then tap .
 - To adjust the font size, spread two fingers apart or pinch on the screen.

Sorting messages

You can sort messages by category and manage them easily.

Launch the **Messages** app and tap **Conversations** → **New category** → **Add category**.

If the category option does not appear, tap  → **Settings** and tap the **Conversations categories** switch to activate it.

Deleting messages

Tap and hold a message to delete, then tap **Delete**.

Changing message settings

Launch the **Messages** app, tap  → **Settings**. You can block unwanted messages, change notification settings, and more.

Internet

Browse the Internet to search for information and bookmark your favourite webpages to access them conveniently.

- 1 Launch the **Internet** app.
- 2 Enter the web address or a keyword, and then tap **Go**.

To view the toolbars, drag your finger downwards slightly on the screen.

To switch between tabs quickly, swipe to the left or right on the address field.

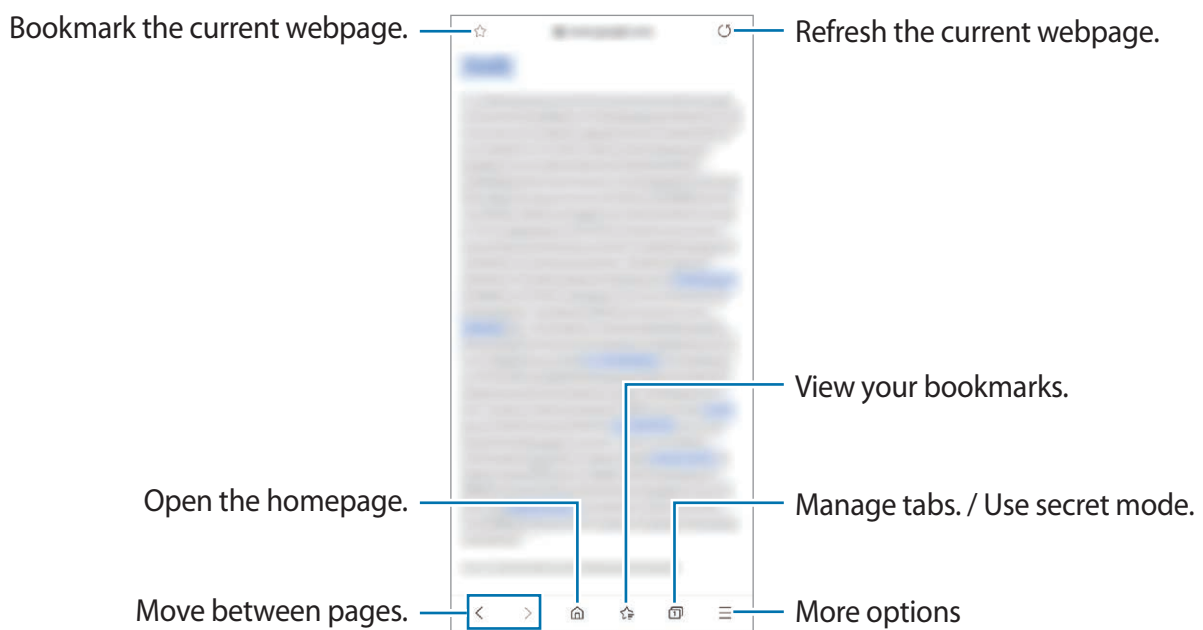

Using secret mode

If you set a password for secret mode, you can prevent others from viewing your search history, browsing history, bookmarks, and saved pages.

- 1 In the toolbar at the bottom of the screen, tap  → **Turn on Secret mode**.
- 2 Tap the **Lock Secret mode** switch to activate it, tap **Start**, and then set a password for secret mode.

In secret mode, the device will change the colour of the toolbars. To deactivate secret mode, tap  in the toolbar at the bottom of the screen and tap **Turn off Secret mode**.

 In secret mode, you cannot use some features, such as screen capture.

Camera

Introduction

Take photos and record videos using various modes and settings.

Camera etiquette

- Do not take photos or record videos of other people without their permission.
- Do not take photos or record videos where legally prohibited.
- Do not take photos or record videos in places where you may violate other people's privacy.

Taking photos

1 Launch the **Camera** app.

You can also launch the app by pressing the Side key twice quickly or dragging  outside the circle on the locked screen.

-  • Some camera features are not available when you launch the **Camera** app from the locked screen or when the screen is turned off while the screen lock method is set.
- The camera automatically shuts off when unused.
- Some methods may not be available depending on the region or service provider.



2 Tap the image on the preview screen where the camera should focus.

To adjust the brightness of photos, tap the screen. When the adjustment bar appears, drag the adjustment bar towards **+** or **-**.

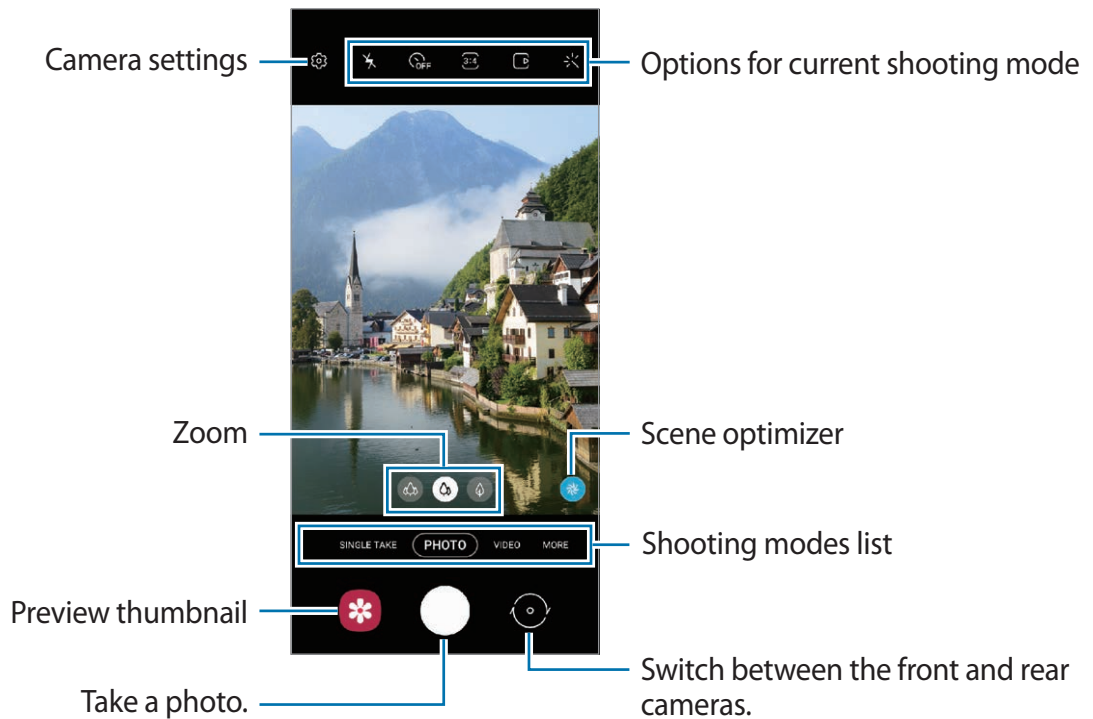

3 Tap  to take a photo.



To change the shooting mode, drag the shooting modes list to the left or right, or swipe to the left or right on the preview screen.



- 
 - The preview screen may vary depending on the shooting mode and which camera is being used.
 - When you take photos or videos with a high resolution or a high zoom ratio, the focus may not be clear if the subject is close. Take photos or videos from a good distance.
 - If photos you take appear blurry, clean the camera lens and try again.
 - Make sure that the lens is not damaged or contaminated. Otherwise, the device may not work properly in some modes that require high resolutions.
 - Minor distortion may occur in wide-angle photos or videos and does not indicate device performance problems. To correct the distortion in photos, tap  on the preview screen, tap **Save options**, and then tap the **Ultra wide shape correction** switch to activate it.
 - The maximum capacity for recording a video may vary depending on the resolution.

Using zoom features

Select  /  /  and drag it to the left or right to zoom in or out. Alternatively, spread two fingers apart on the screen to zoom in, and pinch to zoom out. If the zoom ratio exceeds a certain level, a zoom guide map will appear to indicate where you are zooming in on the image.

-  : The Ultra wide camera lets you take wide-angle photos or record wide-angle videos of things like landscapes.
-  : The wide-angle camera lets you take basic photos or record normal videos.
-  : The telephoto camera lets you take photos or record videos by enlarging the subject.











 Zoom features are available only when using the rear camera.











Using the camera button

- Tap and hold the camera button to record a video.
- To take burst shots, swipe the camera button to the edge of the screen and hold it.
- If you add another camera button, you can move it anywhere on the screen and take photos more conveniently. On the preview screen, tap  → **Shooting methods** and tap the **Floating Shutter button** switch to activate it.

Options for current shooting mode

On the preview screen, use the following options.

-  : Activate or deactivate the flash.
-  : Select the length of the delay before the camera automatically takes a photo.
-  : Select an aspect ratio and resolution for photos.
-  : Activate or deactivate the motion photo feature. If you activate the feature, a video clip will also be taken from a few seconds before tapping the camera button.
-  : Activate or deactivate the super steady feature to stabilize a video..
-  : Activate or deactivate the night hyperlapse feature.
-  : Select a frame rate.
-  : Select an aspect ratio and resolution for videos.
-  : Apply a filter effect or beauty effects.
-  : Record fun videos with virtual handwriting or drawings on faces or anywhere else. Refer to [AR Doodle](#) for more information.

- : Select a metering method. This determines how light values are calculated.  **Centre-weighted** uses the light in the centre portion of the shot to calculate the exposure of the shot.  **Spot** uses the light in a concentrated centre area of the shot to calculate the exposure of the shot.  **Matrix** averages the entire scene.
- : Change the focus area in auto focus mode.  **Multi** focuses on several areas within the frame. Multiple rectangles will appear to indicate the focused areas.  **Centre** focuses on the centre within the frame.
- : Display or hide a graph to check the light distribution in the video.
- : In **FOOD** mode, focus on a subject inside the circular frame and blur the image outside the frame.
- : In **FOOD** mode, adjust the colour tone.
- : Activate or deactivate the motion detection feature when recording super slow-mo videos.

 The available options may vary depending on the model or shooting mode.



Photo mode

The camera adjusts the shooting options automatically depending on the surroundings to capture photos easily.

On the shooting modes list, tap **PHOTO** and tap  to take a photo.

Taking high-resolution photos



Take high-resolution photos. You can crop the high-resolution photos by enlarging the area you want and saving it as a high-resolution file.

In the shooting options, tap  →  or  and take a photo.

 The resolution may vary depending on the model.

Scene optimizer

When the camera recognizes the subject, the scene optimizer button will change and the optimized colour and effect will be applied.

 If this feature is not activated, tap  on the preview screen and tap the **Scene optimizer** switch to activate it.

Shot suggestions

The camera suggests the ideal composition for the photo by recognizing the position and angle of your subject.

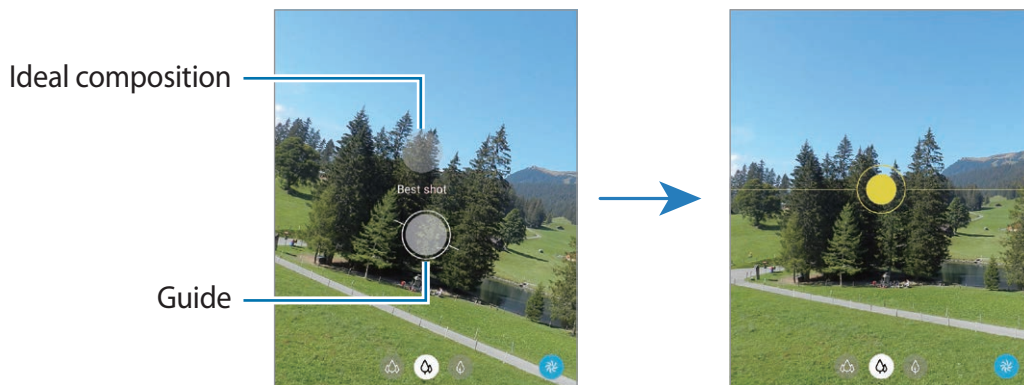

On the preview screen, tap  and tap the **Shot suggestions** switch to activate it.

- 1 On the shooting modes list, tap **PHOTO**.
A guide will appear on the preview screen.
- 2 Point the guide at the subject.
The camera recognizes the composition, and the recommended composition appears on the preview screen.
- 3 Move the device so the guide matches the recommended composition.
When the ideal composition is achieved, the guide will change to yellow.
- 4 Tap  to take a photo.



Taking selfies

You can take self-portraits with the front camera.

- 1 On the preview screen, swipe upwards or downwards, or tap  to switch to the front camera for self-portraits.
- 2 Face the front camera lens.
To take self-portraits with a wide-angle shot of the landscape or people, tap .
- 3 Tap  to take a photo.

Applying filter and beauty effects

You can select a filter effect and modify facial features, such as your skin tone or face shape, before taking a photo.

- 1 On the preview screen, tap .
- 2 Select effects and take a photo.
If you use the My filters feature, you can create your own filter using an image with a colour tone you like from **Gallery**.





Locking the focus (AF) and exposure (AE)

You can lock the focus or exposure on a selected area to prevent the camera from automatically adjusting based on changes to the subjects or light sources.

Tap and hold the area to focus. The AF/AE frame will appear on the area and the focus and exposure setting will be locked. The setting remains locked even after you take a photo.

Video mode

The camera adjusts the shooting options automatically depending on the surroundings to record videos easily.

- 1 On the shooting modes list, tap **VIDEO** and tap  to record a video.
 - To switch between the front and rear cameras while recording, swipe upwards or downwards on the preview screen or tap .
 - To capture an image from the video while recording, tap .
 - To change the focus while recording a video, tap where you want to focus. To use auto focus mode, tap **AF** to cancel the manually set focus.
 - To record the sound from a specific direction at a higher volume while recording a video, point the camera towards that direction and adjust the zoom.
- 2 Tap  to stop recording the video.
 -  • If you use the video zoom feature for a long time while recording a video, the video quality may diminish to prevent your device from overheating.
 - The optical zoom may not work in low-light environments.

Recording high-resolution videos

Record high-resolution videos with a maximum resolution of 8K.

Tap  →  and record a video.

When you finish recording an 8K video, play the video in the **Gallery** app. When you tap  on a frame that you like, the frame will be saved as a high-resolution photo.

Stabilizing videos (Super steady)



When recording videos, stabilize them using the Super steady feature.

Tap **VIDEO** on the shooting modes list, tap  on the shooting options to activate it, and then record a video.

Single take mode

Take various photos and videos in just one shot.

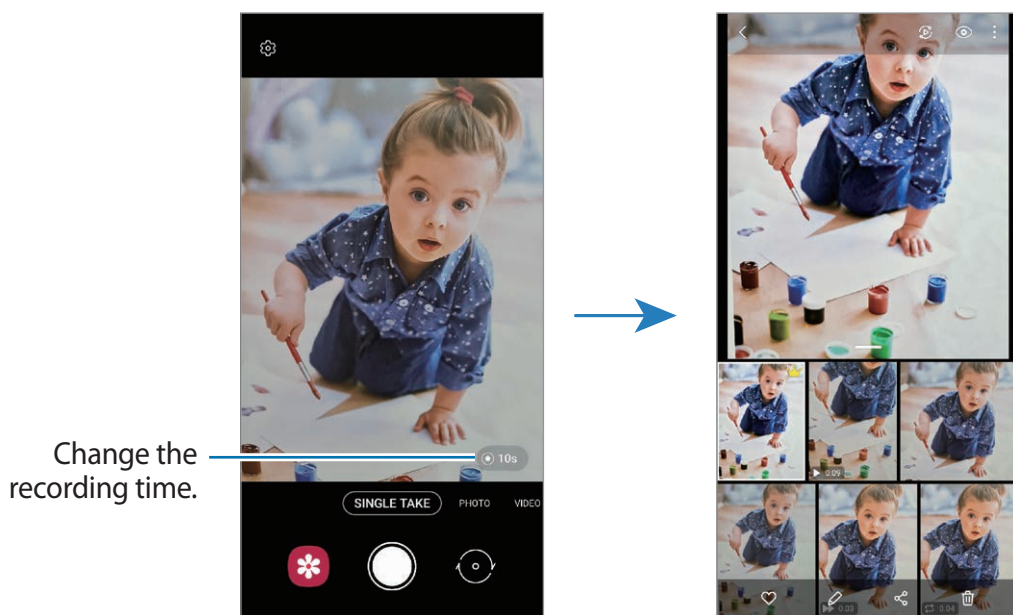

Your device automatically selects the best shot and creates photos with filters or videos with certain sections repeated.

- 1 On the shooting modes list, tap **SINGLE TAKE**.
- 2 Tap  and move the camera to capture the scene you want.
- 3 When you are finished, tap the preview thumbnail.
To view other results, drag the  icon upwards. To save the results individually, tap **Select**, tick the items you want, and then tap .















Pro mode / Pro video mode

Capture photos or videos while manually adjusting various shooting options, such as exposure value and ISO value.

On the shooting modes list, tap **MORE** → **PRO** or **PRO VIDEO**. Select options and customize the settings, and then tap  to take a photo or tap  to record a video.

Available options

-  : Reset the settings.
 -  : Select which direction's sound you want to record at a higher level. You can also use a USB or Bluetooth microphone by connecting it to your device (Pro video mode).
 -  : Select an ISO value. This controls camera light sensitivity. Low values are for stationary or brightly lit objects. Higher values are for fast-moving or poorly lit objects. However, higher ISO settings can result in noise in photos or videos.
 -  : Adjust the shutter speed. A slow shutter speed allows more light in, so the photo or video becomes brighter. This is ideal for photos or videos of scenery or photos or videos taken at night. A fast shutter speed allows less light in. This is ideal for capturing photos or videos of fast-moving subjects.
 -  : Change the exposure value. This determines how much light the camera's sensor receives. If the image is too dark, increase the exposure. If the image is too light, reduce the exposure.
 -  : Change the focus mode. Drag the adjustment bar towards  or  to manually adjust the focus. To switch to auto focus mode, tap **MANUAL**.
 -  : Select an appropriate white balance, so images have a true-to-life colour range. You can set the colour temperature.
 -  : Adjust the colour tone.
 -  : Adjust the zoom speed (Pro video mode).
-  If the shutter speed is set manually, you cannot set the ISO setting to **AUTO** and you cannot change the exposure value. The exposure value will change and be displayed based on the shutter speed setting.

Recording high-resolution pro videos

Record high-resolution pro videos with a maximum resolution of 8K.

Tap  →  or  and record a pro video.

When you finish recording an 8K pro video, play it in the **Gallery** app. When you tap  on a frame that you like, the frame will be saved as a high-resolution photo.

Separating the focus area and the exposure area



You can separate the focus area and the exposure area.

Tap the preview screen where you want the focus area to lock and hold until the AF/AE lock frame appears on the screen, separates into AF lock and AE lock frames, then rejoins to the AF/AE lock frame. Tap again and drag the AE lock frame to the location where you want the exposure area to lock.





Panorama mode

Using panorama mode, take a series of photos and then stitch them together to create a wide scene.

- 1 On the shooting modes list, tap **MORE** → **PANORAMA**.
 - 2 Tap  and move the device slowly in one direction.
Keep the image within the frame on the camera's viewfinder. If the preview image is out of the guide frame or you do not move the device, the device will automatically stop taking photos.
 - 3 Tap  to stop taking photos.
-  Avoid taking photos of indistinct backgrounds, such as an empty sky or a plain wall.

Food mode

Take photos of food with vibrant colours and blurred edges.

- 1 On the shooting modes list, tap **MORE** → **FOOD**.
- 2 Tap the screen and drag the circular frame over the area to highlight.
The area outside the circular frame will be blurred.
To resize the circular frame, drag a corner of the frame.
- 3 Tap  and drag the adjustment bar to adjust the colour tone.
- 4 Tap  to take a photo.



Night mode

Take a photo in low-light conditions, without using the flash. When you use a tripod, you can get brighter and steadier results.

- 1 On the shooting modes list, tap **MORE** → **NIGHT**.
- 2 Tap  and hold your device steady until shooting is complete.

Live focus mode / Live focus video mode

The camera allows you to capture photos or videos where the background is blurred and the subject stands out clearly. You can also apply a background effect and edit it after taking a photo.

- 1 On the shooting modes list, tap **MORE** → **LIVE FOCUS** or **LIVE FOCUS VIDEO**.
- 2 Tap  and select a background effect you want.
To adjust the intensity of the background effect, drag the adjustment bar.
- 3 When **Ready** appears on the preview screen, tap  to take a photo or tap  to record a video.

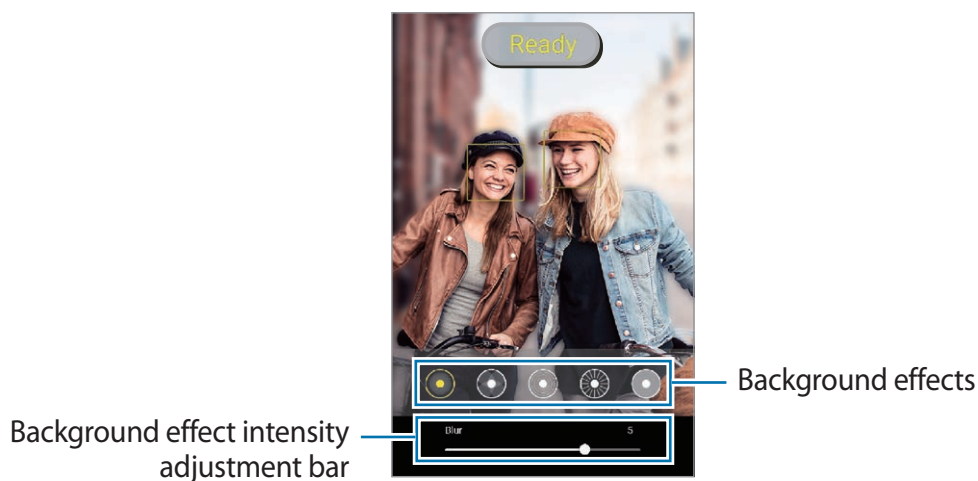

-  • The available options may vary depending on the shooting mode.
- Use this feature in a place that has sufficient light.
- The background blur may not be applied properly in the following conditions:
 - The device or the subject is moving.
 - The subject is thin or transparent.
 - The subject has a similar colour to the background.
 - The subject or background is plain.

Super Slow-mo mode

Super slow motion is a feature that records a quickly passing moment slowly so that you can appreciate it later.

- 1 On the shooting modes list, tap **MORE** → **SUPER SLOW-MO** and tap  to record a video.

The device will capture the moment in super slow motion and save it as a video.

- 2 On the preview screen, tap the preview thumbnail and tap **Play super slow-mo video**. To edit the super slow motion section, tap  → **Editor** and drag the section editing bar to the left or right.

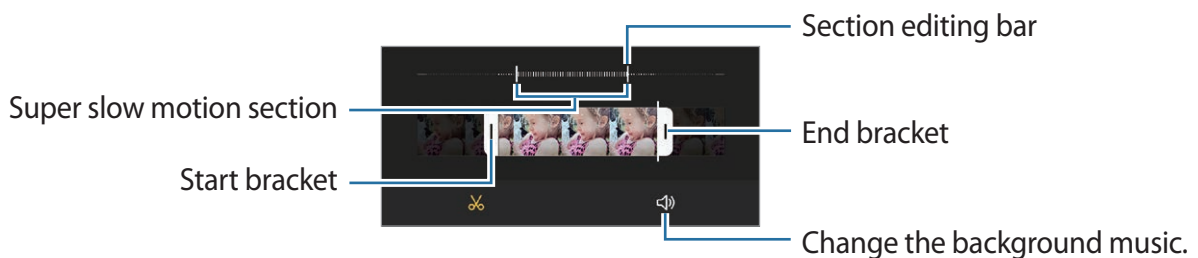

-  Use this feature in a place that has sufficient light. When recording a video indoors with insufficient or poor lighting, the screen may appear dark or be grainy. The screen may flicker in certain lighting conditions, such as in places with fluorescent lighting.

Recording super slow motion videos automatically



To capture the moment in super slow motion when motion is detected in the motion detection area, tap  to activate it. The motion detection feature will be activated and the motion detection area will appear on the preview screen.

Tap  to start recording. When motion is detected, the device will begin recording in super slow motion and save it as a video.

-  Super slow motion recording may start at an unwanted moment if there are conditions such as the following:
 - When the device shakes or when another object is moving near the subject in the motion detection area.
 - When recording under flickering light, such as in places with fluorescent lighting.

Slow motion mode





Record a video for viewing it in slow motion. You can specify sections of your videos to be played in slow motion.

- 1 On the shooting modes list, tap **MORE** → **SLOW MOTION** and tap  to record a video.
- 2 When you are finished recording, tap  to stop.
- 3 On the preview screen, tap the preview thumbnail and tap **Play slow motion video**.
The fast section of the video will be set as a slow motion section and the video will start playing. Up to two slow motion sections will be created based on the video.
To edit the slow motion section, tap  → **Editor** and drag the section editing bar to the left or right.



Hyperlapse mode

Record scenes, such as passing people or cars, and view them as fast-motion videos.

- 1 On the shooting modes list, tap **MORE** → **HYPERLAPSE**.
 - 2 Tap  and select a frame rate option.
If you set the frame rate to **Auto**, the device will automatically adjust the frame rate according to the changing rate of the scene.
 - 3 Tap  to start recording.
 - 4 Tap  to finish recording.
-  You can use the night hyperlapse feature by tapping  on the shooting options. This feature is good for doing things like taking shots from moving cars that make the light look like it is also moving.

Customizing camera settings

On the preview screen, tap . Some options may not be available depending on the shooting mode.

Intelligent features

- **Scene optimizer:** Set the device to adjust the colour settings and apply the optimized effect automatically depending on the subject or scene.
- **Shot suggestions:** Set the device to suggest the ideal composition for the photo by recognizing the position and angle of your subject.
- **Smart selfie angle:** Set the device to automatically switch to a wide-angle selfie when there are more than two people in the frame.
- **Scan QR codes:** Set the device to scan QR codes from the preview screen.

Pictures

- **Swipe Shutter button to edge to:** Select an action to perform when you swipe the camera button to the edge of the screen and hold it.
- **Save options:** Select how you want to save photos.
 - **HEIF pictures (Photo):** Take photos in the High Efficiency Image Format (HEIF).
 - **Save RAW copies:** Set the device to save photos as uncompressed RAW files (DNG file format) in pro mode. RAW files contain unprocessed data from the image sensor for processing using image-processing software. They take up more storage space. When using the **Save RAW copies** feature, each photo is saved in two formats, DNG and JPG.
 - **Ultra wide shape correction:** Set the device to correct distortion in photos taken with the Ultra wide camera.



Videos

- **Rear video size:** Select an aspect ratio and resolution for videos you want to take with the rear camera. Using a higher resolution will result in higher quality videos, but they will take up more storage space.
- **Front video size:** Select an aspect ratio and resolution for videos you want to take with the front camera. Using a higher resolution will result in higher quality videos, but they will take up more storage space.
- **Pro video size:** Select an aspect ratio and resolution for videos you want to take in pro video mode. Using a higher resolution will result in higher quality videos, but they will take up more storage space.

- **Advanced recording options:** Set the device to use an advanced recording option.
 - **High efficiency video:** You can record videos in the High Efficiency Video Codec (HEVC) format. Your HEVC videos will be saved as compressed files to conserve the device's memory.
 - **HDR10+ video:** You can record videos in which each scene's contrast and colour are optimized.
 - **Zoom-in mic:** While recording a video, you can record sound from the zoomed-in direction at a higher volume.
- You cannot play the HEVC videos on other devices or share them online.
- Super slow motion and slow motion videos cannot be recorded in the HEVC format.
- To play the HDR10+ video properly, the device must support HDR10+.
- **Video stabilization:** Activate anti-shake to reduce or eliminate blurry image resulting from camera shake while recording a video.

Useful features

- **Auto HDR:** Take photos with rich colours and reproduce details even in bright and dark areas.
 - **Selfie tone:** Set a tone to apply when you take selfies.
 - **Tracking auto-focus:** Set the device to track and automatically focus on a selected subject. When you select a subject on the preview screen, the device will focus on the subject even if the subject is moving or you change the camera's position.
-  Tracking a subject may fail in the following conditions:
- The subject is too big or too small.
 - The subject moves excessively.
 - The subject is backlit or you are shooting in a dark place.
 - Colours or patterns on the subject and the background are the same.
 - The subject includes horizontal patterns, such as blinds.
 - The camera shakes excessively.
 - The video resolution is high.
 - When zooming in or out using the optical zoom.

- **Pictures as previewed:** Set the device to save photos as they appear on the preview screen when taken with the front camera without flipping them.
 - **Grid lines:** Display viewfinder guides to help composition when selecting subjects.
 - **Location tags:** Attach a GPS location tag to the photo.
 -  • GPS signal strength may decrease in locations where the signal is obstructed, such as between buildings or in low-lying areas, or in poor weather conditions.
 - Your location may appear on your photos when you upload them to the Internet. To avoid this, deactivate the location tag setting.
 - **Shooting methods:** Select additional shooting methods for taking a photo or recording a video.
 - **Settings to keep:** Keep the last settings you used, such as the shooting mode, when you launch the camera.
 - **Storage location:** Select the memory location for storage. This feature will appear when you insert a memory card.
 - **Touch vibrations:** Set the device to vibrate when you touch the screen, such as when you tap the camera button.
 - **Reset settings:** Reset the camera settings.
 - **Contact us:** Ask questions or view frequently asked questions.
 - **About Camera:** View the Camera app version and legal information.
-  Some features may not be available depending on the model.

Gallery

Introduction

View images and videos stored in your device. You can also manage images and videos by album or create stories.

Using Gallery

Launch the **Gallery** app.

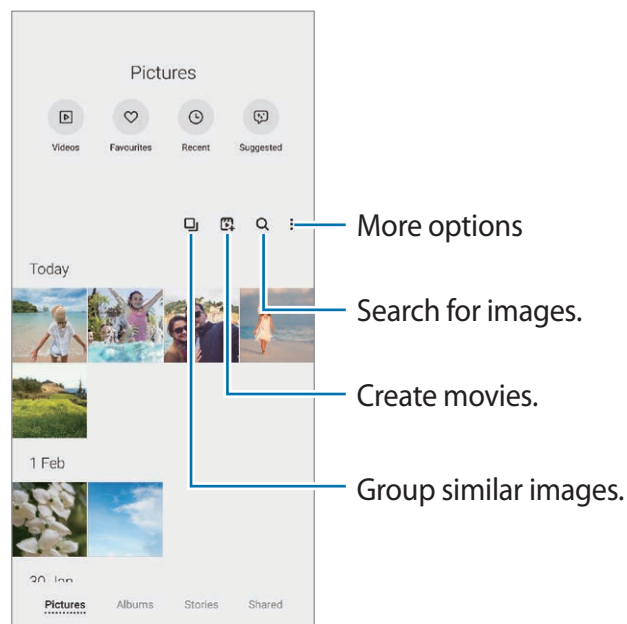

Grouping similar images

Launch the **Gallery** app and tap  to group similar images and display only the best shots as a preview of the images. When you tap the image preview, you can view all the images in the group.

Creating movies

Create a movie by selecting images or videos. Launch the **Gallery** app, tap , tick the files you want to use, and then tap **Create movie**. When you select **Highlight reel**, the device will automatically combine the highlights from the images or videos and create a movie.

Viewing images

Launch the **Gallery** app and select an image. To view other files, swipe to the left or right on the screen.

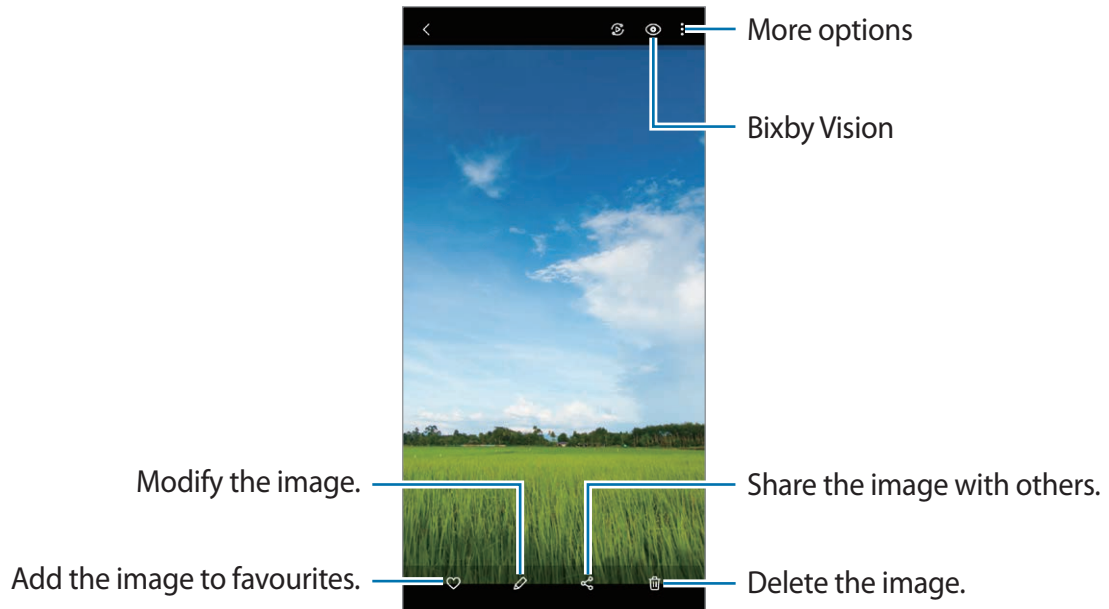

Cropping enlarged images

- 1 Launch the **Gallery** app and select an image.
- 2 Spread two fingers apart on the area you want to save and tap . The cropped area will be saved as a file.

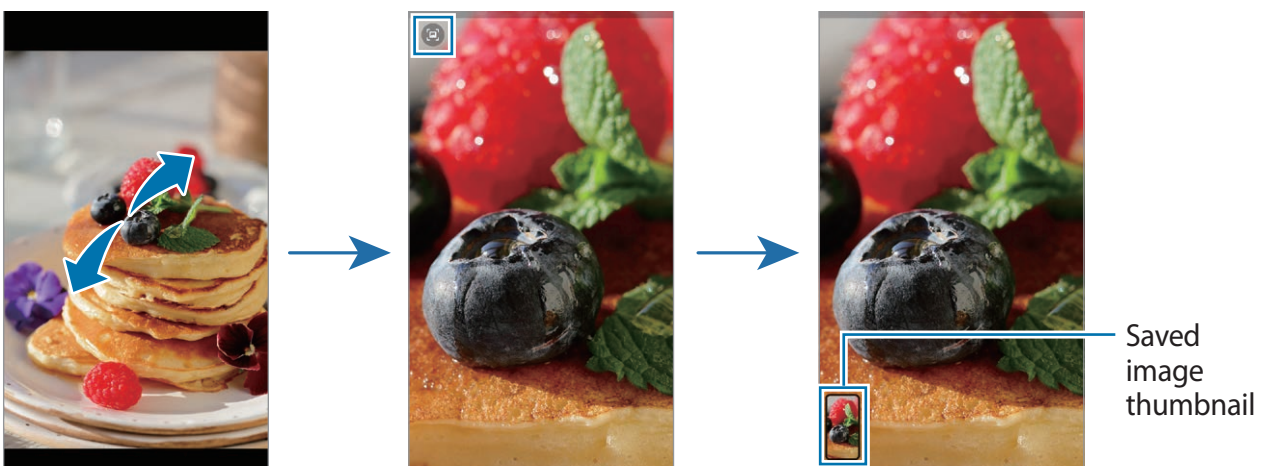

Viewing videos

Launch the **Gallery** app select a video to play. To view other files, swipe to the left or right on the screen.

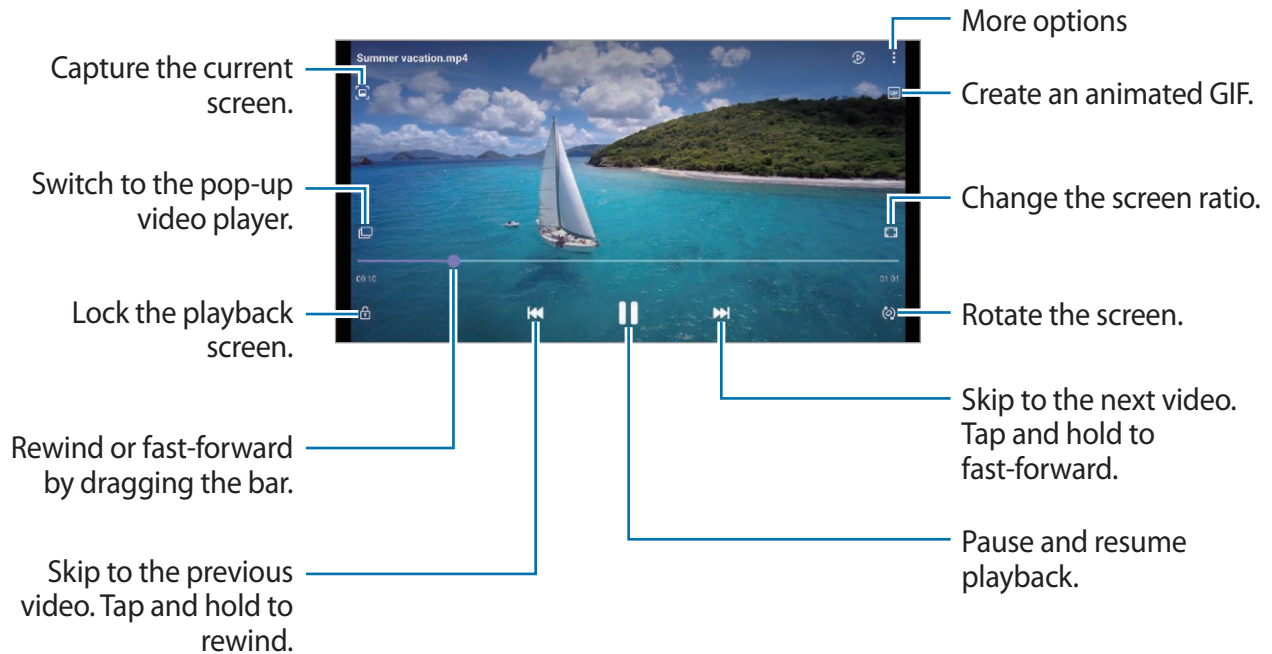

Drag your finger up or down on the left side of the playback screen to adjust the brightness, or drag your finger up or down on the right side of the playback screen to adjust the volume. To rewind or fast-forward, swipe to the left or right on the playback screen.

Viewing brighter and clearer videos

Enhance the image quality of your videos to enjoy brighter and more vivid colours. Launch the **Settings** app, tap **Advanced features**, and then tap the **Video enhancer** switch to activate it.

-  • This feature is only available in some apps.
- Using this feature will increase battery consumption.

Albums

Create albums and sort your images and videos.

- 1 Launch the **Gallery** app and tap **Albums** →  → **Create album** to create an album.
- 2 Select the album, tap **Add items**, and then copy or move the images or videos you want.

Stories

When you capture or save images and videos, the device will read their date and location tags, sort the images and videos, and then create stories.

Launch the **Gallery** app, tap **Stories**, and then select a story.

To add or delete images or videos, select a story and tap **Story album** →  → **Add or Edit**.

Syncing images and videos

Launch the **Gallery** app, tap  → **Settings** → **Cloud sync**, and then follow the on-screen instructions to complete the sync. The **Gallery** app and the cloud will be synced.

When your **Gallery** app is synced with the cloud, photos and videos you take will also be saved in the cloud. You can view images and videos saved in the cloud in your **Gallery** app and from other devices.

 When you connect your Samsung account and Microsoft account, you can set the cloud storage as Microsoft OneDrive.

Deleting images or videos

Launch the **Gallery** app, tap and hold an image, a video, or a story to delete, and then tap **Delete**.

Using the Trash feature

You can keep the deleted images and videos in the trash. The files will be deleted after a certain period.

Launch the **Gallery** app, tap  → **Settings**, and then tap the **Trash** switch to activate it.

To view files in the trash, launch the **Gallery** app and tap  → **Trash**.

AR Zone

Introduction

AR Zone provides you AR related features. Choose a feature and capture fun photos or videos.

Launching AR Zone

Use the following methods to launch AR Zone:



- Launch the **AR Zone** app.
- Launch the **Camera** app and tap **MORE** → **AR ZONE**.

 Available features may vary depending on the region, service provider, or model.

AR Emoji Camera

Creating AR Emoji

Make an emoji that looks like you. Emoji stickers with various expressions will be automatically generated.

- 1 Launch the **AR Zone** app and tap **AR Emoji Camera** → .
- 2 Align your face on the screen, tap  to take a photo, and then follow the on-screen instructions to create an emoji.
Your emoji and its emoji stickers are now created. Refer to [AR Emoji Stickers](#) for more information about emoji stickers.

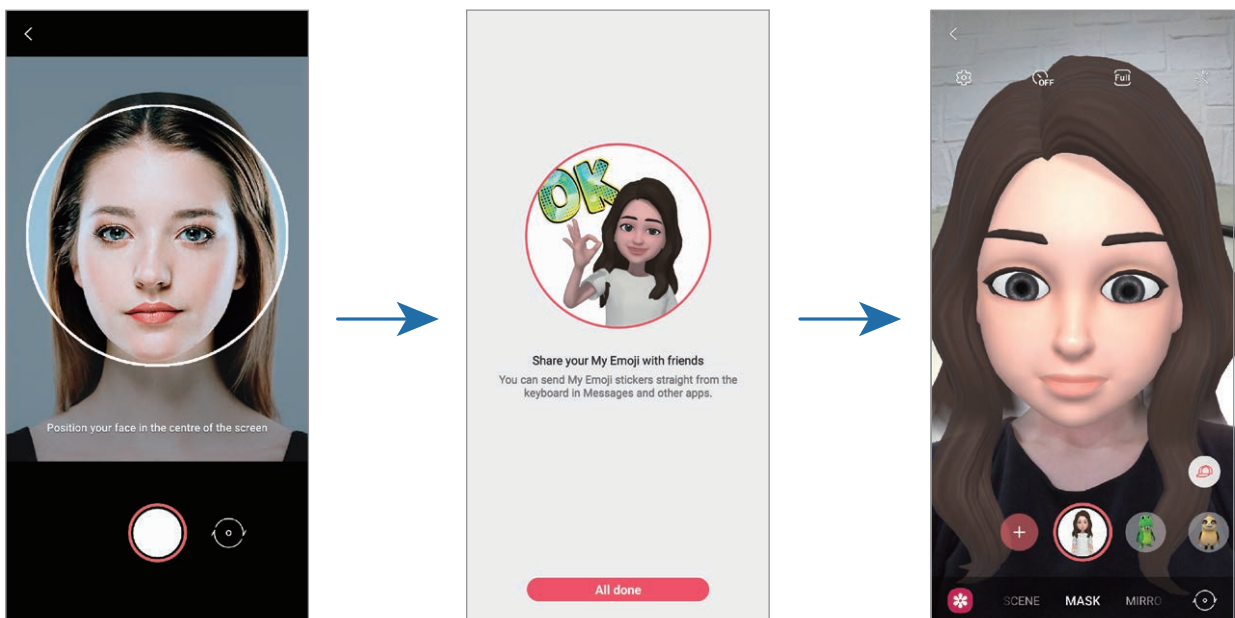

Deleting an emoji

Launch the **AR Zone** app and tap **AR Emoji Camera**. Tap  → **Manage emojis**, tick the emoji you want to delete, and then tap **Delete**. The emoji and its emoji stickers will be deleted.

Capturing photos or videos with emojis

Create fun photos or videos with emojis using various shooting modes.

- 1 Launch the **AR Zone** app and tap **AR Emoji Camera**.
- 2 Select the emoji and the mode you want to use. The available modes may vary depending on the emoji you select.
 - **SCENE**: The emoji mimics your expressions.
 - **MASK**: The emoji's face appears over your face so it looks like you are wearing a mask.
 - **MIRROR**: The emoji mimics your body movements.
 - **PLAY**: The emoji moves on a real background.

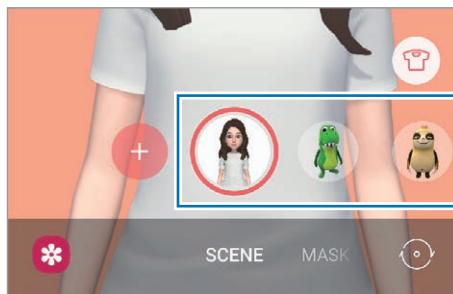

- 3 Tap the emoji icon to take a photo, or tap and hold the icon to record a video. You can view and share the photos and videos that you have captured in **Gallery**.

AR Emoji Stickers

Create your own stickers with your emoji's expressions and actions. You can use your emoji stickers when sending messages or on a social network.

Creating your own stickers

- 1 Launch the **AR Zone** app and tap **AR Emoji Stickers**.
- 2 Tap **Make custom stickers** at the bottom of the screen.
- 3 Edit stickers how you want and tap **Save**. You can view the stickers you have created by tapping **Custom**.

Deleting emoji stickers

Launch the **AR Zone** app and tap **AR Emoji Stickers** →  → **Delete stickers**. Select the emoji stickers to delete and tap **Delete**.

Using your emoji stickers in chats

You can use your emoji stickers during a conversation via messages or on a social network. The following actions are an example of using your emoji stickers in the **Messages** app.

- 1 While composing a message in the **Messages** app, tap  on the Samsung keyboard.
- 2 Tap the emoji icon.
- 3 Select one of your emoji stickers.
The emoji sticker will be inserted.

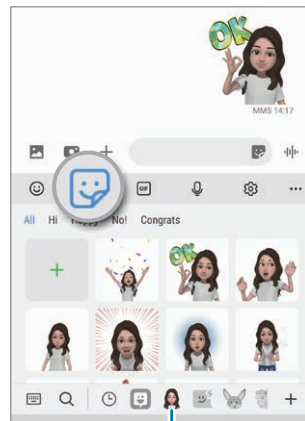

Emoji icon

AR Emoji Studio

Edit or decorate your emoji in the AR Emoji Studio. You can also create clothes with custom patterns and colours for your emoji.

Launch the **AR Zone** app and tap **AR Emoji Studio**.

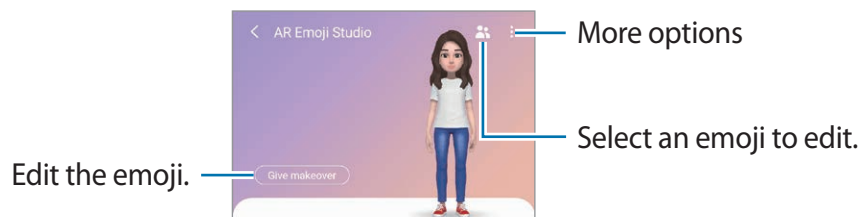

AR Doodle

Record fun videos with virtual handwriting or drawings on people or pets' (cat and dogs) faces or anywhere else. When the camera recognizes a face or space, the doodles on the face will follow the face as it moves, and the doodles in the space will be fixed in the same place even if the camera moves.

- 1 Launch the **AR Zone** app and tap **AR Doodle**.

When the camera recognizes the subject, the recognition area will appear on the screen.

- 2 Write or draw in the recognition area.

- If you switch to the rear camera, you can also write or draw outside the recognition area.
- If you tap  and then begin to doodle, you can record yourself doodling.

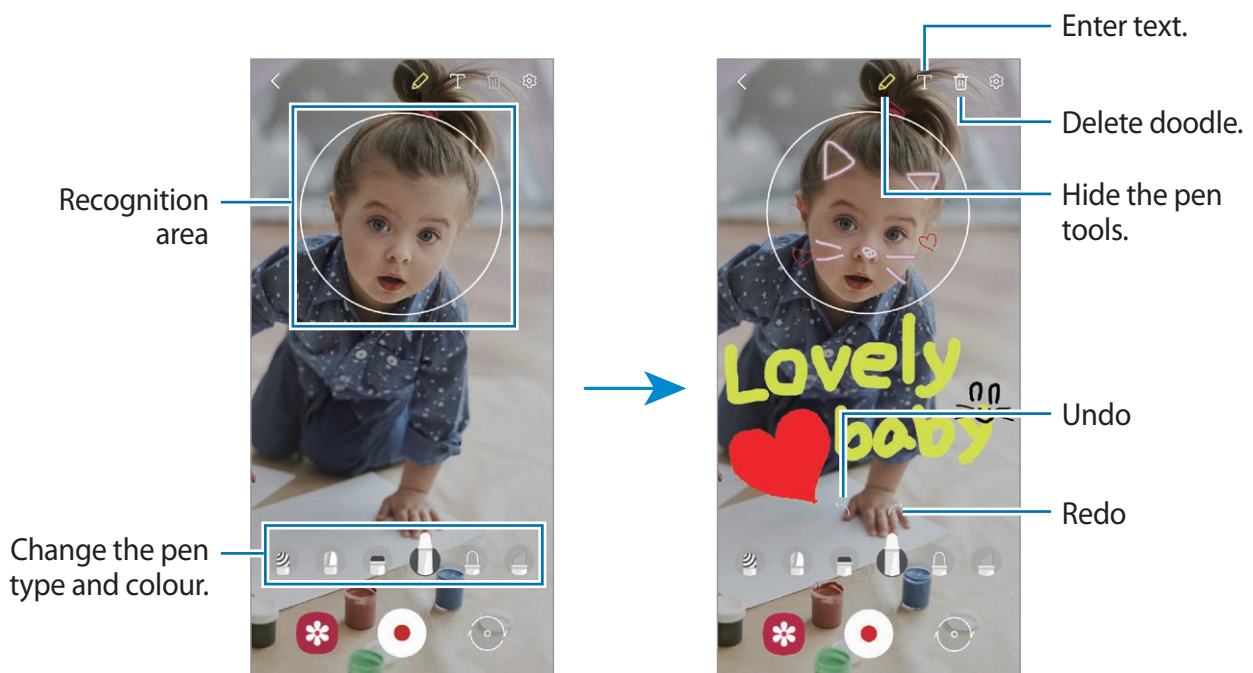

- 3 Tap  to record a video.

- 4 Tap  to stop recording the video.

You can view and share the video in **Gallery**.

Deco Pic

Capture photos or videos with various stickers.

Launch the **AR Zone** app and tap **Deco Pic**.

Bixby

Introduction

Bixby is a user interface that helps you use your device more conveniently.

You can talk to Bixby or type text. Bixby will launch a function you request or show the information you want. Visit www.samsung.com/bixby for more information.

 Bixby is only available in some languages, and it may not be available depending on the region.

Starting Bixby

Press and hold the Side key to launch Bixby. The Bixby intro page will appear. After you select the language to use with Bixby, sign in to your Samsung account, and complete the setup by following the on-screen instructions, the Bixby screen will appear.

Using Bixby



While pressing and holding the Side key, say what you want to Bixby, and then release your finger from the key when you are finished speaking. Alternatively, say "Hi, Bixby" and say what you want.

For example, while pressing and holding the Side key, say "How's the weather today?" The weather information will appear on the screen.

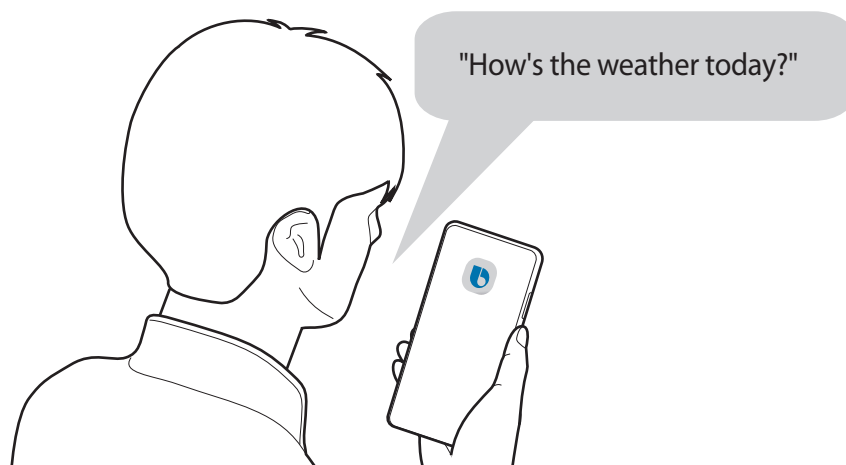
If you want to know the weather tomorrow, while pressing and holding the Side key, just say "Tomorrow?"





If Bixby asks you a question during a conversation, while pressing and holding the Side key, answer Bixby. Or, tap  and answer Bixby.

If you are using headphones or Bluetooth audio devices, or start a conversation by saying “Hi, Bixby”, you can continue the conversation without tapping the icon. Launch the **Bixby** app and tap  →  → **Automatic listening** → **Hands-free only**.

Waking up Bixby using your voice

You can start a conversation with Bixby by saying “Hi, Bixby”. Register your voice so that Bixby will respond to your voice when you say “Hi, Bixby”.

- 1 Launch the **Bixby** app and tap  →  → **Voice wake-up**.
- 2 Tap the **Wake with “Hi, Bixby”** switch to activate it.
- 3 Follow the on-screen instructions to complete the setup.
Now you can say “Hi, Bixby” and start a conversation.

Communicating by typing text

If your voice is not recognized due to noisy environments or if you are in a situation where speaking is difficult, you can communicate with Bixby via text.

Launch the **Bixby** app, tap , and then type what you want.

During the communication, Bixby will also answer you through text instead of voice feedback.

Bixby Vision

Introduction

Bixby Vision is a service that provides various features based on image recognition. You can use Bixby Vision to quickly search for information by recognizing objects. Use a variety of useful Bixby Vision features.





-  • This feature may not be available or you may not get correct search results depending on the image size, format, or resolution.
- Samsung is not responsible for the product information provided by Bixby Vision.

Launching Bixby Vision

Launch Bixby Vision using one of these methods.

- In the **Camera** app, tap **MORE** on the shooting modes list and tap **BIXBY VISION**.
- In the **Gallery** app, select an image and tap .
- In the **Internet** app, tap and hold an image and tap **Bixby Vision**.
- If you added the Bixby Vision app icon to the Apps screen, launch the **Bixby Vision** app.

Using Bixby Vision

- 1 Launch Bixby Vision.
- 2 Select a feature you want to use.
 -  : Recognize text from documents or images and translate it.
 -  : Search for images similar to the recognized object online and related information.
 -  : Search for information on products.
 -  : Recognize QR codes and view information.

-  The available features and search results may vary depending on the region or service provider.

Bixby Routines

Introduction

Add your repeated usage patterns as routines and use your device more conveniently.

For example, a 'before bed' routine will perform actions such as turning on silent mode and dark mode, to reduce strain on your eyes and ears when you use the device before going to bed.

Adding routines

- 1 Launch the **Settings** app and tap **Advanced features** → **Bixby Routines**.
- 2 On the **Discover** list, select a routine you want or tap **+** to add your own routines.
 - You can set the conditions and actions of routines on the **Discover** list.
 - If you want to set the routine's running condition to manual, tap **Start button tapped**. This option will appear only when there are no running conditions set. When a pop-up window appears, tap **Add**. You can add the routine to the Home screen as a widget and access it quickly.

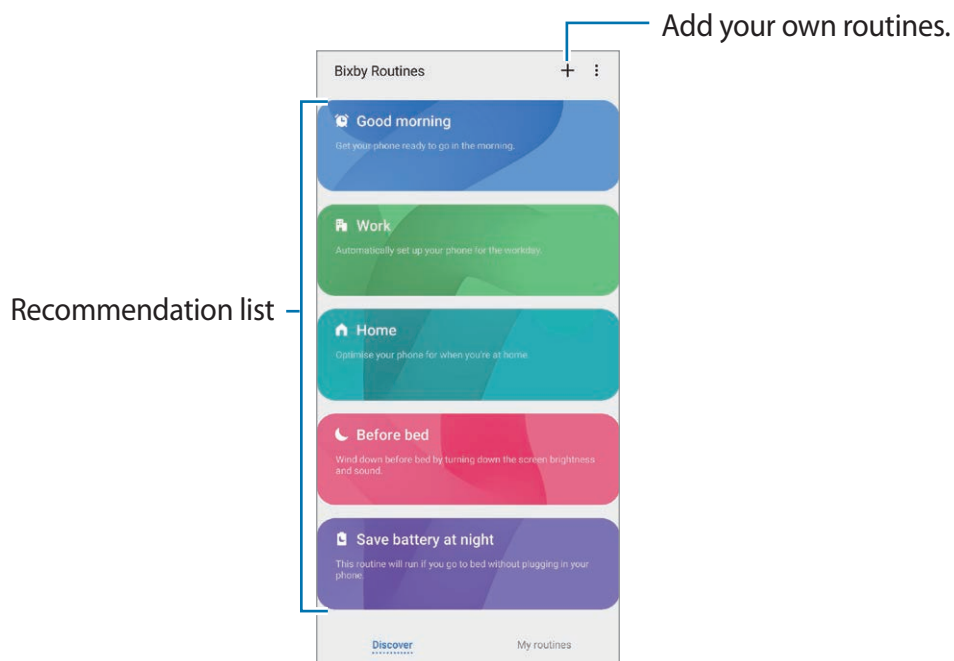

Adding recommended routines

When your device learns your usage patterns, it will recommend adding useful or frequently used features as routines.

When the recommendation notification appears, tap **View all** and add it as your own routine.

Using routines

Running auto routines

Auto routines will run automatically when their conditions are detected.

Running manual routines

For manual routines where you set the running condition as **Start button tapped**, you can run them manually by tapping the button whenever you want.

Launch the **Settings** app and tap **Advanced features** → **Bixby Routines** → **My routines** and tap  next to the routine you want to run. Alternatively, tap the routine's widget on the Home screen.

Viewing running routines

Currently running routines will appear on the notification panel. To view a routine's details, tap the notification.

You can also quickly stop running routines. On the notification panel, tap  next to a routine and tap **Stop**.

Managing routines

Launch the **Settings** app and tap **Advanced features** → **Bixby Routines** → **My routines**. Your routines will appear.

To deactivate a routine, tap the routine's switch or .

To delete routines, tap  → **Delete**, tick routines to delete, and then tap **Delete**.

Multi window

Introduction

Multi window lets you run two apps at the same time in the split screen view. You can also run multiple apps at the same time in the pop-up view.

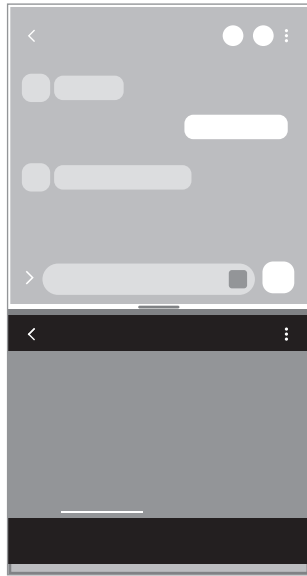

Split screen view

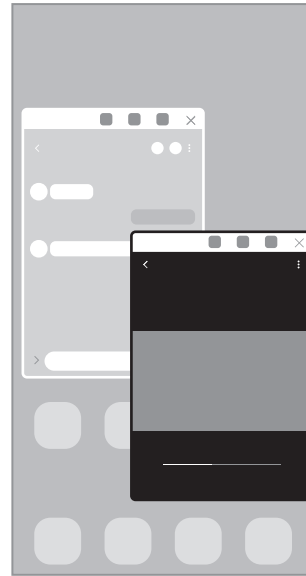

Pop-up view

 Some apps may not support this feature.

Split screen view



- 1 Tap the Recents button to open the list of recently used apps.
- 2 Swipe to the left or right, tap an app's icon, and then tap **Open in split screen view**. The selected app will launch in the split screen view.
- 3 On the other window, swipe left or right to select another app to launch. To launch apps not on the list of recently used apps, tap the Home button or Back button and select an app.

Launching apps from the Edge panel

- 1 While using an app, drag the Edge panel handle towards the centre of the screen.
- 2 Tap and hold an app, drag it to the left, and then drop it where **Drop here to open** appears.



The selected app will launch in the split screen view.



You can set to launch an app in the split screen view by tapping it once. Tap  →  and tap **Tap** under **Open in split screen view**. If you tap the **Show recent apps** switch to activate it, you can launch the recently used apps in the split screen view from the Edge panel.

Adding app pairs

Add two frequently used apps to the Edge panel to launch them together in the split screen view with a single tap.

- 1 In the split screen view, tap  between the app windows.
 - 2 Tap .
- The two apps you are using in the split screen view will be saved on the Edge panel as an app pair.

Adjusting the window size

Drag the bar between the app windows up or down to adjust the size of the windows.

When you drag the bar between the app windows to the top or bottom edge of the screen, the window will be maximized.

Pop-up view

- 1 Tap the Recents button to open the list of recently used apps.
- 2 Swipe to the left or right, tap an app's icon, and then tap **Open in pop-up view**.
The app screen will appear in the pop-up view.
If you tap the Home button while using a pop-up window, the window will be minimized and displayed as an app icon. To use the pop-up window again, tap the app icon.

Launching apps from the Edge panel

- 1 Drag the Edge panel handle towards the centre of the screen.
- 2 Tap and hold an app, drag it to the left, and then drop it where **Drop here for pop-up view** appears.

The selected app will launch in the pop-up view.

Moving pop-up windows

To move a pop-up window, tap the window's toolbar and drag it to a new location.

Samsung Daily

View the latest news and various content, such as videos and games.

On the Home screen, swipe to the right. The Samsung Daily screen will appear.

When launching this feature for the first time or after performing a data reset, follow the on-screen instructions to complete the setup.

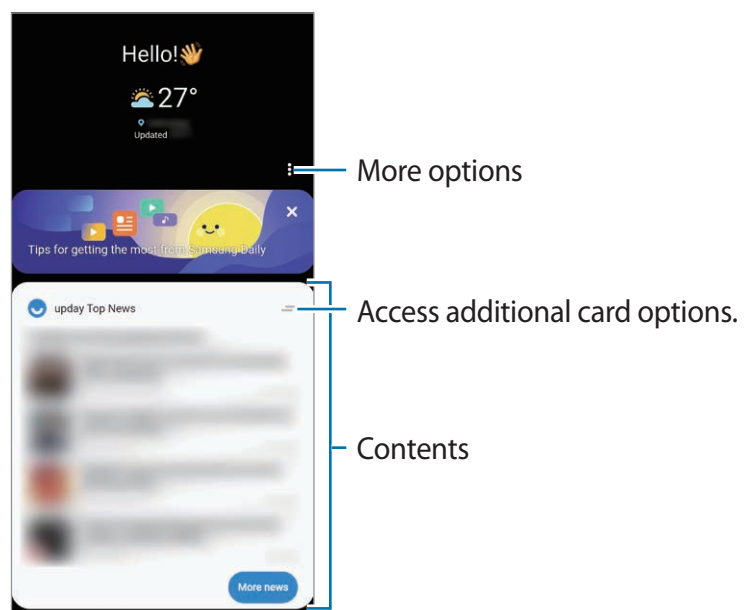

If you want to deactivate Samsung Daily, tap and hold an empty area, or pinch your fingers together on the Home screen. Then, swipe to the right on the screen and tap the **Samsung Daily** switch to deactivate it.

-  The content of the cards update automatically at a specified interval. You can update cards whenever you want by swiping downwards on the screen.

Samsung Pay

Introduction

Register cards to Samsung Pay to make both online and offline payments quickly and securely.

You can view more information, such as cards that support this feature at www.samsung.com/samsung-pay.



- To make payments with Samsung Pay, the device may require a connection to a Wi-Fi or mobile network depending on the region.
- This app's availability and supported features may vary depending on the region or service provider.
- The procedures for the initial setup and card registration may vary depending on the region or service provider.
- Magnetic secure transmission (MST) may not be supported depending on the region.

Setting up Samsung Pay

When running this app for the first time or restarting it after performing a data reset, follow the on-screen instructions to complete the initial setup.

- 1 Launch the **Samsung Pay** app.
- 2 Sign in to your Samsung account and read and agree to the terms and conditions.
- 3 Register your fingerprint and a PIN to use when making payments.
This PIN will be used to verify various actions in Samsung Pay, such as making payments and unlocking the app.

Registering cards

You can easily register cards by capturing their images with the camera.

Launch the **Samsung Pay** app and follow the on-screen instructions to complete your card registration.

Making payments

- 1 Tap and hold a card image at the bottom of the screen and drag it upwards. Alternatively, launch the **Samsung Pay** app. Then, on the cards list, swipe to the left or right and select a card to use.

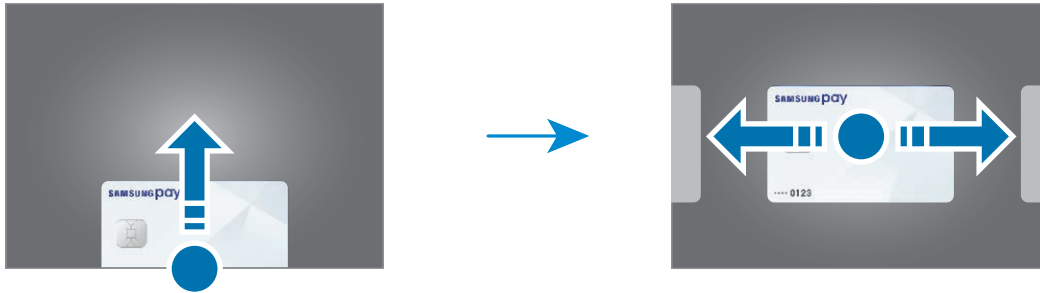

- 2 Scan your fingerprint or enter the payment PIN you set.
 - 3 Touch the back of your device to the card reader.
When the card reader recognizes the card information, the payment will be processed.
- Payments may not be processed depending on your network connection.
 - The verification method for payments may vary depending on the card readers.

Cancelling payments

You can cancel payments by visiting the place where you made them.

On the cards list, swipe to the left or right to select the card you used. Follow the on-screen instructions to complete payment cancellation.

Samsung Health

Introduction

Samsung Health helps you manage your wellness and fitness. Set fitness goals, check your progress, and keep track of your overall wellness and fitness. You can also compare your step count records with other Samsung Health users and view health tips.

Visit www.samsung.com/samsung-health for more information.

Using Samsung Health

Launch the **Samsung Health** app. When running this app for the first time or restart it after performing a data reset, follow the on-screen instructions to complete the setup.

To edit items on the Samsung Health home screen, tap **Manage items** at the bottom of the trackers list.

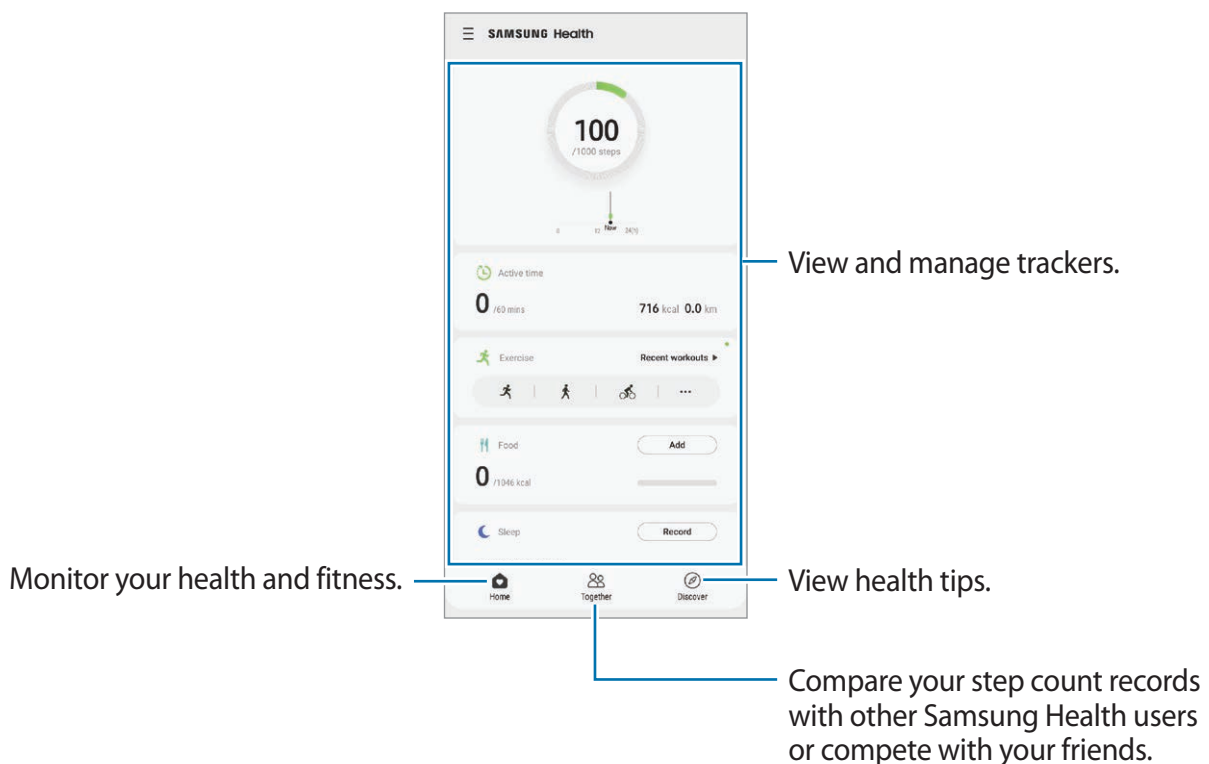



- Some features may not be available depending on the region.
- If you use the steps tracker while travelling by car or train, vibration may affect your step count.

Samsung Notes

Introduction

Create notes by entering text from the keyboard or by handwriting or drawing on the screen. You can also insert images or voice recordings into your notes.

Creating notes

- 1 Launch the **Samsung Notes** app, tap , and then create a note.
You can change the input method by tapping  or .

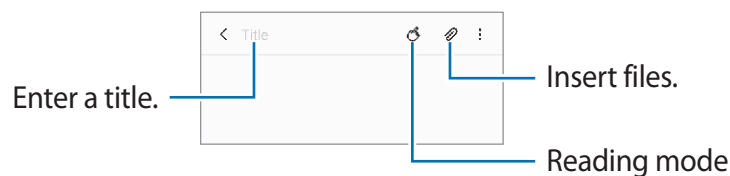

- 2 When you are finished composing the note, tap the Back button to save it.
If you want to save the note in another file format, tap  → **Save as file**.

Deleting notes

Tap and hold a note to delete and tap **Delete**.

Composing notes with handwriting

On the note composer screen, tap  to write or draw with the S Pen.

You can enter your handwriting more easily if you magnify the screen by spreading two fingers on it.

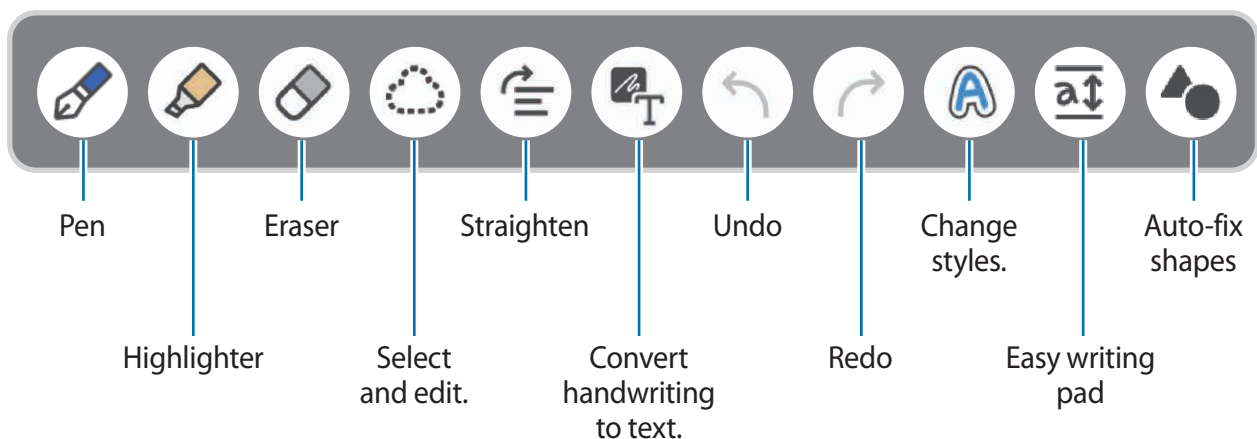

Using the eraser

When you want to erase handwriting from a note, tap  and select an area to erase. Alternatively, select an area while pressing and holding the S Pen button.



To change the eraser type, tap  once more.

- **Stroke eraser:** Erase the line you select.
- **Area eraser:** Erase only the area you select. You can adjust the size of the eraser by dragging the size adjustment bar.

 Even with a smaller eraser, you may still not be able to precisely erase the intended part.

Editing handwritten notes

Edit handwritten notes using various editing options, such as cutting, moving, or resizing.

- 1 When there is handwriting on the note, tap .
To change the shape of the selection, tap  once more.
- 2 Tap or draw a line around the input to select.
 - To move the input to another location, select the input, and then drag it to a new location.
 - To change the size of the selection, tap the input and drag a corner of the frame that appears.

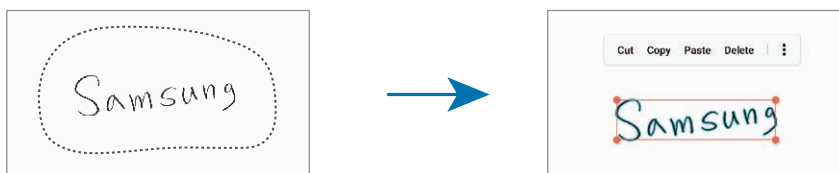

- 3 Edit the input using the available options.

Straightening content horizontally

You can horizontally straighten your handwriting and drawings.

After writing or drawing on the screen, tap .

Changing styles

You can change the style of your handwriting and drawings.

After writing or drawing on the screen, tap **A** twice and select a colour or line thickness you want. Then, point the S Pen toward where you want to apply the style. When the **→** icon appears, tap where you want to change the style.



Converting handwriting to text

After writing on the screen, tap **T**. Options will appear in the preview window. If you drag **↑** or **↓**, you can select the handwriting you want. To replace the handwriting with the text, tap **Convert**.

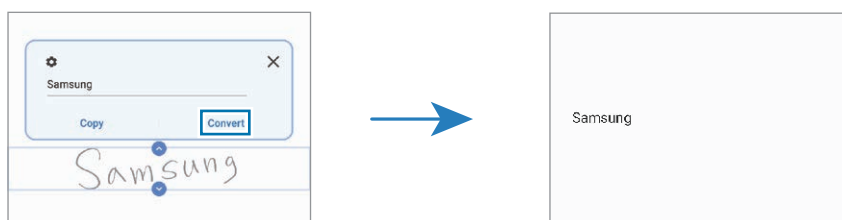

Using the easy writing pad

Use the easy writing pad to enter your handwriting more easily.

On the note composer screen, tap **a↕**. The input field will be magnified and appear as the easy writing pad.





Automatically fixing shapes

Tap  and draw a shape. The shape will be fixed.

Recording voice to notes

Make a recording of your voice while creating a note, and then the content will be synchronized with the recording.

On the note composer screen, tap  → **Voice recordings** and create a note.

Select a note from the list and tap  to play the recording. Then the content you created while recording will be displayed on the screen along with the recording.

Adding memos to PDF files

Launch the **Samsung Notes** app, tap , and then select a PDF file. You can add memos to the PDF file.

Pinning a note to the Home screen

Pin a note to the Home screen to quickly view it or open and edit it.

- 1 Launch the **Samsung Notes** app.
- 2 Select a note and tap  → **Pin to home screen**.
The note will be added to the Home screen.

Samsung Members

Samsung Members offers support services to customers, such as device problem diagnosis, and lets users submit questions and error reports. You can also share information with others in the Galaxy users' community or view the latest news and tips. **Samsung Members** can help you solve any problems you might encounter while using your device.

Samsung Galaxy

Access the Samsung website and view various information related to products.

Launch the **Samsung Galaxy** app.

PENUP

PENUP is a social network service for sharing artwork drawn with the S Pen. Post your artwork, view others' artwork, and get useful drawing tips.

Launch the **PENUP** app.

Galaxy Wearable

Galaxy Wearable is an app that allows you to manage your wearable devices. When you connect your device to the wearable device, you can customize the wearable device's settings and apps.



Launch the **Galaxy Wearable** app.

Tap **Get started** to connect your device to the wearable device. Follow the on-screen instructions to finish the setup. Refer to the wearable device's user manual for more information about how to connect and use the wearable device with your device.

Calendar



Manage your schedule by entering upcoming events in your planner.

Creating events

- 1 Launch the **Calendar** app and tap  or double-tap a date.
If the date already has saved events or tasks in it, tap the date and tap .
- 2 Enter event details and tap **Save**.

Syncing events with your accounts

- 1 Launch the **Settings** app, tap **Accounts and backup** → **Accounts**, and then select the account to sync with.
- 2 Tap **Sync account** and tap the **Calendar** switch to activate it.
For the Samsung account, tap  → **Sync settings** and tap the **Calendar** switch to activate it.

To add accounts to sync with, launch the **Calendar** app and tap  →  → **Add new account**. Then, select an account to sync with and sign in. When an account is added, a blue circle is displayed next to the account name.

Reminder

Register to-do items as reminders and receive notifications according to the condition you set.



- To receive more accurate notifications, connect to a Wi-Fi or mobile network.
- To use location reminders, the GPS feature must be activated. Location reminders may not be available depending on the model.

Starting Reminder

Launch the **Calendar** app and tap  → **Reminder**. The Reminder screen will appear and the Reminder app icon () will be added to the Apps screen.

Creating reminders

- 1 Launch the **Reminder** app.
- 2 Tap **Write a reminder** or , enter the details, and then tap **Save**.

Completing reminders

On the reminders list, select a reminder and tap **Complete**.

Restoring reminders

Restore reminders that have been completed.



- 1 On the reminders list, tap  → **Completed** → **Edit**.
- 2 Tick items to restore and tap **Restore**.
Reminders will be added to the reminders list and you will be reminded again.

Deleting reminders

To delete a reminder, select a reminder and tap **Delete**. To delete multiple reminders, tap and hold a reminder, tick reminders to delete, and then tap **Delete**.

Voice Recorder

Record or play voice recordings.

- 1 Launch the **Voice Recorder** app.
- 2 Tap  to start recording. Speak into the microphone.
 - Tap  to pause recording.
 - While making a voice recording, tap **BOOKMARK** to insert a bookmark.
- 3 Tap  to finish recording.
- 4 Enter a file name and tap **Save**.

Changing the recording mode

Select a mode from the top of the voice recorder screen.

- **Standard:** This is the normal recording mode.
- **Interview:** The device records sound from the top and the bottom of the device at a high volume while reducing the volume of sound from the sides.
- **Speech-to-text:** The device records your voice and simultaneously converts it to on-screen text. For best results, keep the device near your mouth and speak loudly and clearly in a quiet place.



If the voice memo system language does not match the language you are speaking, the device will not recognize your voice. Before using this feature, tap the current language to set the voice memo system language.

Playing selected voice recordings

When you review interview recordings, you can mute or unmute certain sound sources in the recording.

- 1 Tap **List** and select a voice recording made in interview mode.
- 2 To mute certain sound sources, tap  for the corresponding direction that sound is to be muted.

The icon will change to  and the sound will be muted.

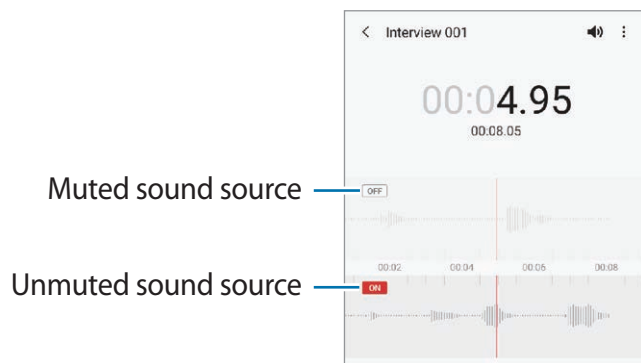

My Files

Access and manage various files stored in the device.

Launch the **My Files** app.

To check for unnecessary data and free up the device's storage, tap **Analyze storage**.

To search for files or folders, tap **Q**.

Clock





Set alarms, check the current time in many cities around the world, time an event, or set a specific duration.

Launch the **Clock** app.

Calculator

Perform simple or complex calculations.



Launch the **Calculator** app.

- : View the calculation history. To clear the history, tap **Clear history**. To close the calculation history panel, tap .
- : Use the unit conversion tool. You can convert various values, such as area, length, or temperature, into other units.
- : Display the scientific calculator.

Game Launcher

Game Launcher gathers your games downloaded from **Play Store** and **Galaxy Store** into one place for easy access. You can set the device to game mode to play games more easily.

Launch the **Game Launcher** app and select the game you want.

-  • If **Game Launcher** does not appear, launch the **Settings** app, tap **Advanced features**, and then tap the **Game Launcher** switch to activate it.
- Games downloaded from **Play Store** and **Galaxy Store** will be automatically shown on the Game Launcher screen. If you cannot see your games, drag the Library panel upwards and tap  → **Add apps**.

Removing a game from Game Launcher

Drag the Library panel upwards, tap and hold a game, and then tap **Remove from Game Launcher**.

Changing the performance mode

You can change the game performance mode.

Launch the **Game Launcher** app, tap  → **Game performance** → **Game performance**, and then select the mode you want.



- **Focus on performance:** This focuses on giving you the best possible performance while playing games.
- **Balanced:** This balances the performance and the battery usage time.
- **Focus on power saving:** This saves battery power while playing games.

 Battery power efficiency may vary by game.

Game Booster

Game Booster lets you play games in a better environment. You can use Game Booster while playing games.

To open the Game Booster panel while playing games, tap  on the navigation bar. If the navigation bar is hidden, drag upwards from the bottom of the screen to show it. If you have set the navigation bar to use **Full screen gestures**, open the notification panel and tap **Tap to open Game Booster**.

- : Configure settings for Game Booster.
- **Monitoring temperature / Monitoring memory**: Set the device to automatically adjust settings to prevent device overheating and to stop apps running in the background to better manage memory.
- **Block during game**: Lock some features during games.
- **Navigation button lock**: Hide the buttons on the navigation bar. To display the buttons, tap  on the navigation bar.
- **Screen touch lock**: Lock the touchscreen while the game is being played. To unlock the touchscreen, drag the lock icon in any direction.
- **Screenshot**: Capture screenshots.

-  You can set to open the Game Booster panel from the navigation bar while the navigation bar is set to **Full screen gestures**. On the Game Booster panel, tap **Block during game** and tap the **Navigation gestures** switch to activate it.
- Available options may vary depending on the game.

Launching apps in pop-up windows while playing games

You can launch apps in pop-up windows while playing a game.

Tap  and select an app from the apps list.

Samsung Kids

You can restrict children's access to only certain apps, set their usage times, and configure settings to provide a fun and safe environment for children when they use the device.

Open the notification panel, swipe downwards, and then tap  (**Samsung Kids**) to activate it. The Samsung Kids screen will appear. When starting Samsung Kids for the first time or after performing a data reset, follow the on-screen instructions to complete the setup.

On the Samsung Kids screen, select the app you want to use.

 Your preset screen lock method or your created PIN will be used when activating the **Parental control** feature or closing Samsung Kids.

Using parental control features

You can configure the settings for Samsung Kids and view the usage history.

On the Samsung Kids screen, tap  → **Parental control** and enter your unlock code.

Closing Samsung Kids

To close Samsung Kids, tap the Back button or tap  → **Close Samsung Kids**, and then enter your unlock code.

SmartThings

Control and manage smart appliances and Internet of Things (IoT) products with your smartphone.

To view more information, launch the **SmartThings** app and tap  → **How to use**.

- 1 Launch the **SmartThings** app.
- 2 Tap  → **Device**.
- 3 Select a device and connect to it by following the on-screen instructions.

-  • Connection methods may vary depending on the type of connected devices or the shared content.
- The devices you can connect may vary depending on the region or service provider. Available features may differ depending on the connected device.
 - Connected devices' own errors or defects are not covered by the Samsung warranty. When errors or defects occur on the connected devices, contact the device's manufacturer.

Sharing content

Share content by using various sharing options. The following actions are an example of sharing images.



- 1 Launch the **Gallery** app and select an image.
- 2 Tap  and select a sharing method you want.

 You may incur additional charges when sharing files via the mobile network.

Quick Share

Share content with nearby devices via Wi-Fi Direct or Bluetooth, or with SmartThings supported devices.

Sharing content with nearby devices



- 1 Launch the **Gallery** app and select an image.
- 2 On the other device, open the notification panel, swipe downwards, and then tap  (**Quick Share**) to activate it.
- 3 Tap  → **Quick Share** and select a device to receive the image.
- 4 Accept the file transfer request on the other device.

 This feature does not support sharing videos with TVs or SmartThings supported devices. To watch videos on TV, use the Smart View feature.

Pointing to share (Galaxy Note20 Ultra 5G, Note20 Ultra)

Share content by pointing the device among the nearby devices.

This feature is available only on Galaxy devices that support the UWB (Ultra-wideband) feature. Also, the screen of the other device receiving files must be turned on.



- 1 Launch the **Gallery** app and select an image.
- 2 On the other device, open the notification panel, swipe downwards, and then tap  (**Quick Share**) to activate it.
- 3 On the other device, tap and hold  (**Quick Share**) and tap the **Show my position to others** switch to activate it.
- 4 Tap the other device when it appears at the top of the screen.

5 Accept the file transfer request on the other device.

 The UWB feature may not be available depending on the region.

Setting who can find your device

Set who is allowed to find and send content to your device.

- 1 Open the notification panel, swipe downwards, and then tap  (**Quick Share**) to activate it.
- 2 Tap and hold  (**Quick Share**).
The Quick Share settings screen will appear.
- 3 Select an option.
 - **Contacts only:** Allow only your contacts to share with your device.
 - **Everyone:** Allow any nearby devices to share with your device.

Link Sharing

Share large files. Upload files to the Samsung storage server and share them with others via a Web link.

- 1 Launch the **Gallery** app and select an image.
- 2 Tap  → **Link Sharing**.
The link for the image will be created.
- 3 Select a sharing option.

Shared album

Create a shared album to share photos or videos with others, and download your files whenever you want.

- 1 Launch the **Gallery** app and select an image.
- 2 Tap  → **Shared album**.
- 3 Select an album to share.
If there is no album to share, tap **Create shared album** and follow the on-screen instructions to create an album.

-  • When you play a high-resolution video from a shared album, the video connection may drop depending on the network speed.
- Content that is larger than 1 GB cannot be shared to a shared album.

Music Share



Introduction

The Music Share feature allows you to share your Bluetooth speaker that is already connected to your device with another person. You can also listen to the same music on your Galaxy Buds and another person's Galaxy Buds.

This feature is available only on devices that support the Music Share feature.

Sharing a Bluetooth speaker

You can listen to music on your smartphone and your friend's smartphone via your Bluetooth speaker.



- 1 Make sure that your smartphone and your Bluetooth speaker are connected.
Refer to [Pairing with other Bluetooth devices](#) for how to connect.
- 2 On your smartphone, open the notification panel, swipe downwards, and then check if  (**Music Share**) is activated.
You can use additional features, such as setting who to share your device with, by tapping and holding  (**Music Share**).
- 3 On your friend's smartphone, select your speaker from the list of the Bluetooth devices.
- 4 On your smartphone, accept the connection request.
Your speaker will be shared.
When you play music via your friend's smartphone, the music playing via your smartphone will be paused.

Listening to music together with Galaxy Buds

You can listen to music stored on your smartphone together through your Buds and your friend's Buds.

This feature is supported only on Galaxy Buds, Galaxy Buds Plus, and Galaxy Buds Live.

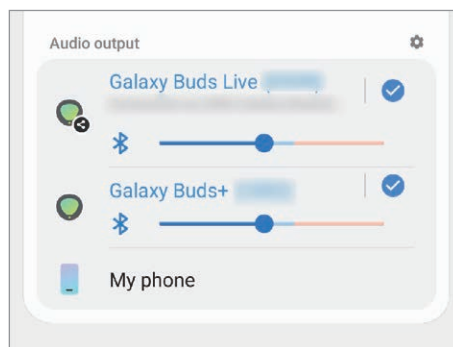

- 1 Make sure that each smartphone and pair of Buds are connected.
Refer to [Pairing with other Bluetooth devices](#) for how to connect.

- 2 On your friend's smartphone, open the notification panel, swipe downwards, and then tap  (**Music Share**) to activate it.
You can use additional features, such as setting who to share your device with, by tapping and holding  (**Music Share**).
- 3 On your smartphone, open the notification panel and tap **Media**.
- 4 Tap  and select your friend's Buds from the detected devices list.
- 5 On your friend's smartphone, accept the connection request.
- 6 On your smartphone, tick your Buds and your friend's Buds on the audio output list.
When you play music via your smartphone, you can listen to it together via both Buds.



Smart View

View your device's displayed content on a large screen by connecting your device to a screen mirroring-enabled TV or monitor.

- 1 Open the notification panel, swipe downwards, and then tap  (**Smart View**).
 - 2 Select a device to mirror your device's screen or display content.
-  When you play a video with Smart View, the resolution may vary depending on the TV model.

Samsung DeX

Introduction

Samsung DeX is a service that allows you to use your smartphone like a computer by connecting the smartphone to an external display, such as a TV or monitor, or to a computer. Accomplish tasks you want done on your smartphone quickly and easily on a large screen using a keyboard and mouse. While using Samsung DeX, you can simultaneously use your smartphone.

Connecting devices and starting Samsung DeX

Wired connections to external displays

You can connect your smartphone to an external display using an HDMI adapter (USB Type-C to HDMI).



- All accessories are sold separately.
- Use only official Samsung DeX supported accessories that are provided by Samsung. Performance problems and malfunctions caused by using accessories that are not officially supported are not covered by the warranty.

- 1 Connect an HDMI adapter to your smartphone.
- 2 Connect an HDMI cable to the HDMI adapter and to a TV or monitor's HDMI port.

3 On your smartphone's screen, tap **Start**.

Without changing your smartphone's screen, the Samsung DeX screen will appear on the connected TV or monitor.

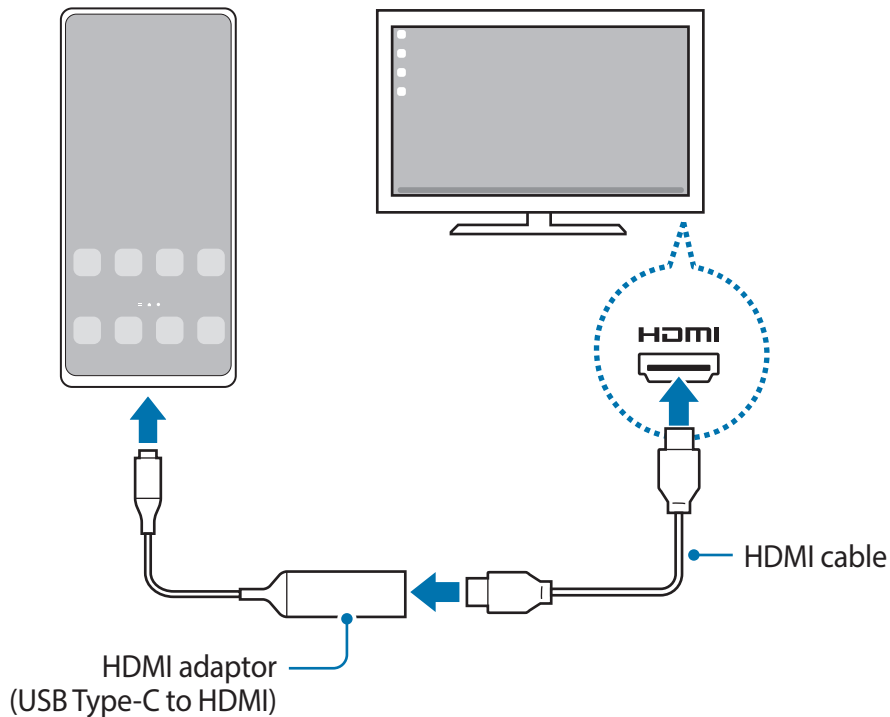

Wired connections to computers

You can use Samsung DeX by connecting your smartphone to a computer using a USB cable. To use the USB cable supplied with the device, the computer must have a USB Type-C port.

- 1 On a computer, visit www.samsung.com/samsung-dex and download the Samsung DeX app.
- 2 Connect your smartphone to a computer using a USB cable.

- 3 On your smartphone's screen, tap **Start now**.
When they are connected, the Samsung DeX screen will appear on the computer.

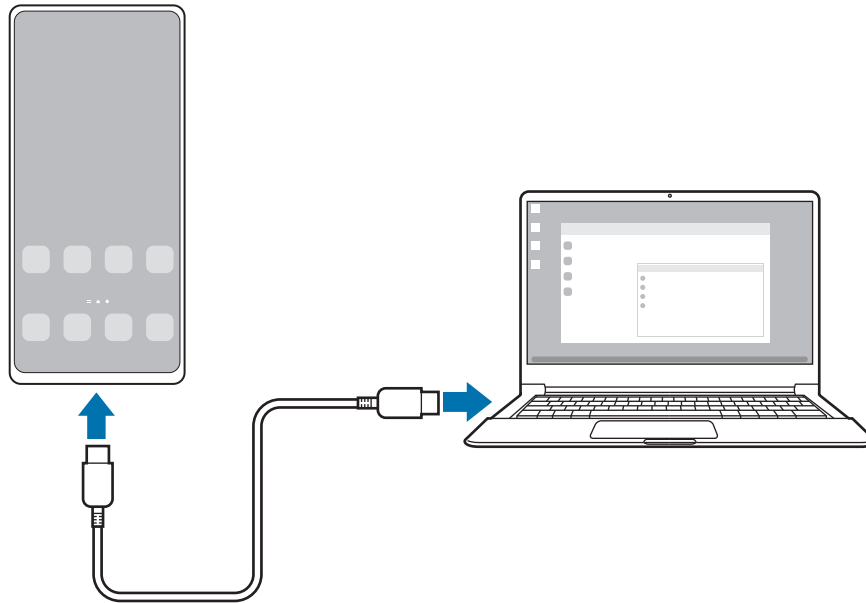

Connecting to a TV wirelessly

You can use Samsung DeX by connecting your smartphone to a TV wirelessly.

- 1 On your smartphone, open the notification panel, swipe downwards, and then tap  (**DeX**).
- 2 Select a TV from the detected devices list and tap **Start now**.
- 3 Accept the connection request on the TV.
- 4 Follow the on-screen instructions to complete the connection.

When they are connected, the Samsung DeX screen will appear on the TV.

-  • It is recommended to use a Samsung Smart TV manufactured after 2019.
- Make sure that screen mirroring is supported on the TV you want to connect to.

Controlling the Samsung DeX screen

Controlling on an external display

Controlling with an external keyboard and mouse

You can use a wireless keyboard/mouse. Refer to the respective device's manual for more information.

- You can set the mouse pointer to flow from the external display to the smartphone's screen. Launch the **Settings** app, select **Samsung DeX** → **Mouse/trackpad**, and then select the **Flow pointer to phone screen** switch to activate it.
- You can also use the external keyboard on the smartphone's screen.

Using your smartphone as a touchpad

You can use your smartphone as a touchpad and operate it with your fingers.

On your smartphone, drag downwards from the top of the screen to open the notification panel and tap **Use your phone as a touchpad**.

- If you open the notification panel, you can view the gestures you can use with the touchpad.
- If your smartphone's case has a front cover, open the front cover to use your smartphone as a touchpad. If the front cover is closed, the touchpad may not work properly.
- If your smartphone's screen turns off, press the Side key or double-tap the screen to turn on the screen.

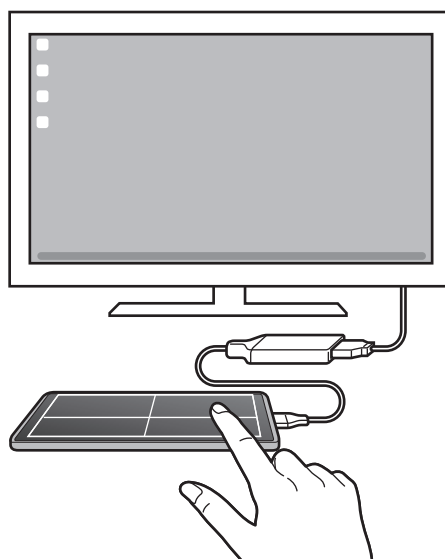

Using the screen keyboard

When you enter text to send messages, create notes, or perform other tasks, a screen keyboard will appear automatically on your smartphone's screen without connecting an external keyboard.

Controlling on a computer

Control the Samsung DeX screen using the keyboard and mouse connected to the computer. You can move files easily between the computer and Samsung DeX by drag and drop, and you can also copy and paste text.

- To view keyboard shortcuts available while using Samsung DeX, launch the **Settings** app and tap **General management** → **Language and input** → **Physical keyboard** → **Keyboard shortcuts**.

Using Samsung DeX

Use your smartphone's features in an interface environment similar to a computer. You can multitask by running multiple apps simultaneously. You can also check your smartphone's notifications and status.



- The Samsung DeX screen layout may differ depending on the connected device.
- When starting or ending Samsung DeX, running apps may be closed.
- Some apps or features may not be available when using Samsung DeX.
- To adjust the screen settings, use the connected TV or monitor's display settings.
- To change the audio output, tap the status bar, select **Media**, and then select a device under **Audio output**.

Using Samsung DeX and smartphone simultaneously

While using Samsung DeX, you can use separate apps on the external display or the computer and your smartphone simultaneously.

For example, while watching a video on the connected TV or monitor, you can chat with your friend on a messenger.

On the connected TV or monitor, launch an app to run on the Samsung DeX screen. Then, launch another app on your smartphone.

Locking the Samsung DeX screen

If you want to lock the external display and your smartphone's screen while using Samsung DeX, select  → **Lock DeX**.



While using Samsung DeX, you cannot lock the external display and your smartphone's screen by pressing the Side key.

Transferring data with a computer

Copying files

On the Samsung DeX screen, click and hold a file to select it in the **My Files** app or **Gallery** app and drag it to the computer screen. On the computer screen, select a file and drag it to the Samsung DeX screen, the **My Files** app, or the **Gallery** app.

Copying and pasting text

Using the keyboard shortcut keys, copy text on the Samsung DeX screen or computer screen and paste it in the text input field on the other screen.

Link to Windows

You can connect your device to a Windows PC to instantly access your device's data, such as photos or messages, on the computer.

When calls or messages come in, you can receive them on the computer.

- This feature is only available on Windows 10 version 1803 or higher, and it is recommended to use the latest version to fully use this feature.
- A Microsoft account is required to use this feature. When you create a Microsoft account, you can sign in to all Microsoft devices and services, such as Microsoft Office programs and Windows 10.

Connecting to a computer

- 1 Launch the **Settings** app and tap **Advanced features** → **Link to Windows**.
- 2 Follow the on-screen instructions to complete the connection.

Visit <https://aka.ms/setupltw> for details.

Viewing data and notifications from your device on the computer

Launch the **Your Phone** app on the computer and select a category you want.

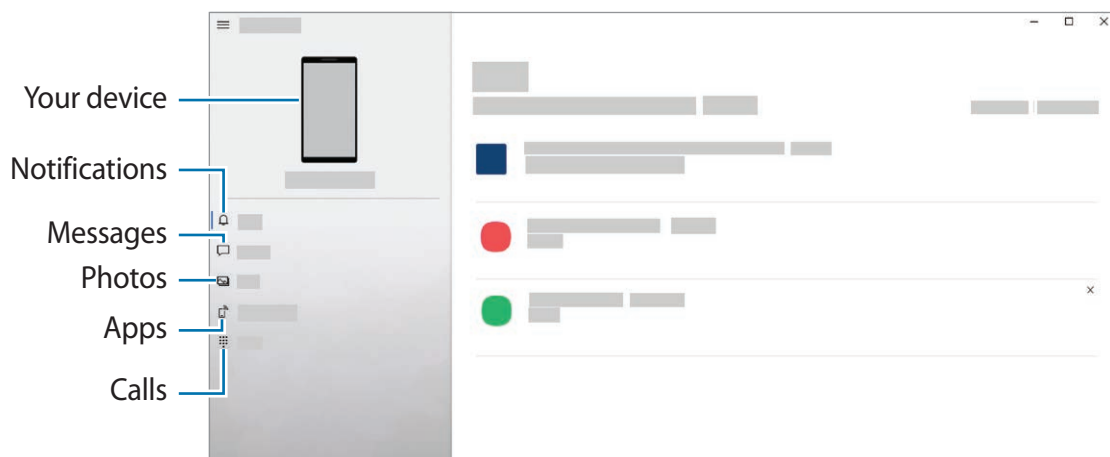

Available features and menus may vary depending on the software version or model.

Samsung Global Goals

The Global Goals, which were established by the United Nations General Assembly in 2015, consist of goals that aim to create a sustainable society. These goals have the power to end poverty, fight inequality, and stop climate change.

With Samsung Global Goals, learn more about the global goals and join the movement for a better future.

Google apps

Google provides entertainment, social network, and business apps. You may require a Google account to access some apps.

To view more app information, access each app's help menu.

- **Chrome:** Search for information and browse webpages.
- **Gmail:** Send or receive emails via the Google Mail service.
- **Maps :** Find your location on the map, search the world map, and view location information for various places around you.
- **YT Music :** Enjoy various music and videos provided by YouTube Music. You can also view the music collections stored on your device and play them.
- **Play Movies & TV:** Purchase or rent videos, such as movies and TV programs, from **Play Store**.
- **Drive:** Store your content on the cloud, access it from anywhere, and share it with others.
- **YouTube:** Watch or create videos and share them with others.
- **Photos:** Search for, manage, and edit all your photos and videos from various sources in one place.
- **Google:** Search quickly for items on the Internet or your device.
- **Duo:** Make a simple video call.

 Some apps may not be available or may be labeled differently depending on the region or service provider.

Settings

Introduction

Customize device settings.

Launch the **Settings** app.

To search for settings by entering keywords, tap **Q**.

Connections

Options

Change settings for various connections, such as the Wi-Fi feature and Bluetooth.

On the Settings screen, tap **Connections**.

- **Wi-Fi:** Activate the Wi-Fi feature to connect to a Wi-Fi network and access the Internet or other network devices. Refer to [Wi-Fi](#) for more information.
- **Bluetooth:** Use Bluetooth to exchange data or media files with other Bluetooth-enabled devices. Refer to [Bluetooth](#) for more information.
- **NFC and payment:** Set the device to allow you to read near field communication (NFC) tags that contain information about products. You can also use this feature to make payments and buy tickets for transportation or events after downloading the required apps. Refer to [NFC and payment](#) for more information.
- **Flight mode:** Set the device to disable all wireless functions on your device. You can use only non-network services.
 - ⚠ Follow the regulations provided by the airline and the instructions of aircraft personnel. In cases where it is allowed to use the device, always use it in flight mode.
- **Mobile networks:** Configure your mobile network settings.

- **Data usage:** Keep track of your data usage amount and customize the settings for the limitation. Set the device to automatically disable the mobile data connection when the amount of mobile data you have used reaches your specified limit.

You can activate the data saver feature to prevent some apps running in the background from sending or receiving data. Refer to [Data saver](#) for more information.

You can also select apps to always use the mobile data even when your device is connected to a Wi-Fi network. Refer to [Mobile data only apps](#) for more information.

- **Mobile Hotspot and Tethering:** Use the device as a mobile hotspot to share the device's mobile data connection with other devices. For more information about the mobile hotspot, refer to [Mobile Hotspot](#).



You may incur additional charges when using this feature.

- **More connection settings:** Customize settings to control other features. Refer to [More connection settings](#) for more information.



Wi-Fi

Activate the Wi-Fi feature to connect to a Wi-Fi network and access the Internet or other network devices.

Connecting to a Wi-Fi network

- 1 On the Settings screen, tap **Connections** → **Wi-Fi** and tap the switch to activate it.
- 2 Select a network from the Wi-Fi networks list.
Networks with a lock icon require a password.



- Once the device connects to a Wi-Fi network, the device will reconnect to that network each time it is available without requiring a password. To prevent the device from connecting to the network automatically, tap  next to the network and tap the **Auto reconnect** switch to deactivate it. To delete the saved connection information for a network, tap  next to the network and tap **Forget**.
- If you cannot connect to a Wi-Fi network properly, restart your device's Wi-Fi feature or the wireless router.

Viewing the Wi-Fi network quality information

View the Wi-Fi network quality information, such as the speed and stability.

On the Settings screen, tap **Connections** → **Wi-Fi** and tap the switch to activate it. The network quality information will appear under the Wi-Fi networks. If it does not appear, tap **⋮** → **Advanced** and tap the **Show network quality info** switch to activate it.

 The quality information may not appear depending on the Wi-Fi network.

Sharing network passwords

If you make a request to a person who is connected to a secured Wi-Fi network to share its password, you can connect to the network without entering the password. This feature is available between the devices which have contacts each other and the screen of the other device must be turned on.

- 1 On the Settings screen, tap **Connections** → **Wi-Fi** and tap the switch to activate it.
- 2 Select a network from the Wi-Fi networks list.
- 3 Tap **Request password**.
- 4 Accept the share request on the other device.
The Wi-Fi password is entered on your device and it is connected to the network.

Wi-Fi Direct

Wi-Fi Direct connects devices directly via a Wi-Fi network without requiring an access point.

- 1 On the Settings screen, tap **Connections** → **Wi-Fi** and tap the switch to activate it.
- 2 Tap **⋮** → **Wi-Fi Direct**.
The detected devices are listed.
If the device you want to connect to is not in the list, turn on its Wi-Fi Direct feature.
- 3 Select a device to connect to.
The devices will be connected when the other device accepts the Wi-Fi Direct connection request.
To end the device connection, select the device to disconnect from the list.

Sending and receiving data

You can share data, such as contacts or media files, with other devices. The following actions are an example of sending an image to another device.

- 1 Launch the **Gallery** app and select an image.
- 2 Tap  → **Wi-Fi Direct** and select a device to receive the image.
- 3 Accept the Wi-Fi Direct connection request on the other device.
If the devices are already connected, the image will be sent to the other device without the connection request procedure.

Bluetooth

Use Bluetooth to exchange data or media files with other Bluetooth-enabled devices.

-  • Samsung is not responsible for the loss, interception, or misuse of data sent or received via Bluetooth.
 - Always ensure that you share and receive data with devices that are trusted and properly secured. If there are obstacles between the devices, the operating distance may be reduced.
 - Some devices, especially those that are not tested or approved by the Bluetooth SIG, may be incompatible with your device.
 - Do not use the Bluetooth feature for illegal purposes (for example, pirating copies of files or illegally tapping communications for commercial purposes). Samsung is not responsible for the repercussion of illegal use of the Bluetooth feature.

Pairing with other Bluetooth devices

- 1 On the Settings screen, tap **Connections** → **Bluetooth** and tap the switch to activate it.
The detected devices will be listed.
 - 2 Select a device to pair with.
If the device you want to pair with is not on the list, set the device to enter Bluetooth pairing mode. Refer to the other device's user manuals.
-  Your device is visible to other devices while the Bluetooth settings screen is open.

- 3 Accept the Bluetooth connection request on your device to confirm.
The devices will be connected when the other device accepts the Bluetooth connection request.
To unpair the devices, tap  next to the device name to unpair and tap **Unpair**.

Sending and receiving data

Many apps support data transfer via Bluetooth. You can share data, such as contacts or media files, with other Bluetooth devices. The following actions are an example of sending an image to another device.

- 1 Launch the **Gallery** app and select an image.
- 2 Tap  → **Bluetooth** and select a device to receive the image.
If the device you want to pair with is not in the list, turn on its visibility option.
- 3 Accept the Bluetooth connection request on the other device.

NFC and payment

Your device allows you to read near field communication (NFC) tags that contain information about products. You can also use this feature to make payments and buy tickets for transportation or events after downloading the required apps.

-  The device contains a built-in NFC antenna. Handle the device carefully to avoid damaging the NFC antenna.

Reading information from NFC tags

Use the NFC feature to read product information from NFC tags.

- 1 On the Settings screen, tap **Connections** and tap the **NFC and payment** switch to activate it.

- 2 Place the NFC antenna area on the back of your device near an NFC tag. The information from the tag appears.

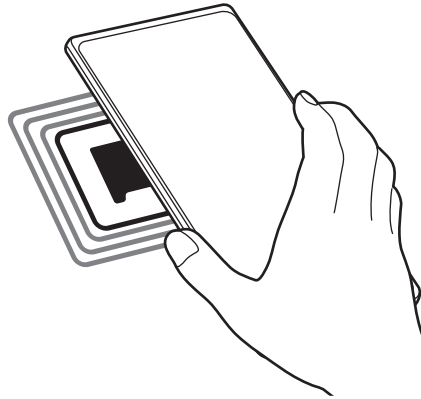

-  Ensure that the device's screen is turned on and unlocked. Otherwise, the device will not read NFC tags or receive data.

Making payments with the NFC feature

Before you can use the NFC feature to make payments, you must register for the mobile payment service. To register or get more information about the service, contact your service provider.

- 1 On the Settings screen, tap **Connections** and tap the **NFC and payment** switch to activate it.
- 2 Touch the NFC antenna area on the back of your device to the NFC card reader.

To set the default payment app, open the Settings screen and tap **Connections** → **NFC and payment** → **Tap and pay** → **PAYMENT**, and then select an app.

-  The payment services list may not include all available payment apps.

Sending data with the NFC feature

Transfer data, such as images or contacts, with other devices by touching your device's NFC antenna to the other device's NFC antenna.

- 1 On the Settings screen, tap **Connections** → **NFC and payment** and tap the switch to activate it.
- 2 Tap the **Android Beam** switch to activate it.

- 3 Select an item and touch the other device's NFC antenna to your device's NFC antenna.
 - 4 When **Touch to beam.** appears on the screen, tap your device's screen to send the item.
-  If both devices try to send data simultaneously, the file transfer may fail.

Data saver

Reduce your data usage by preventing some apps running in the background from sending or receiving data.

On the Settings screen, tap **Connections** → **Data usage** → **Data saver** and tap the switch to activate it.

When the data saver feature is activated, the  icon will appear on the status bar.



-  To select apps to use data without restriction, tap **Allow app while Data saver on** and select apps.

Mobile data only apps

Select apps to always use mobile data even when your device is connected to a Wi-Fi network.





For example, you can set the device to use only mobile data for apps that you want to keep secure or streaming apps that can be disconnected. Even if you do not deactivate the Wi-Fi feature, the apps will launch using mobile data.

On the Settings screen, tap **Connections** → **Data usage** → **Mobile data only apps**, tap the switch to activate it, and then tap the switches next to the apps you want.

-  You may incur additional charges when using this feature.

Mobile Hotspot

Use your device as a mobile hotspot to share your device's mobile data connection with other devices.

- 1 On the Settings screen, tap **Connections** → **Mobile Hotspot and Tethering** → **Mobile Hotspot**.
 - 2 Tap the switch to activate it.
The  icon appears on the status bar.
You can change the level of security and the password by tapping  → **Configure Mobile Hotspot**.
 - 3 On the other device's screen, search for and select your device from the Wi-Fi networks list. Alternatively, tap  on the mobile hotspot screen and scan the QR code with the other device.
-  • If the mobile hotspot is not found, on your device, set **Band** to **2.4 GHz**, tap  → **Configure Mobile Hotspot**, and then deselect **Hide my device**.
 - If you activate the **Auto Hotspot** feature, you can share your device's mobile data connection with other devices signed in to your Samsung account.

More connection settings

Customize settings to control other connection features.

On the Settings screen, tap **Connections** → **More connection settings**.

- **Nearby device scanning:** Set the device to scan for nearby devices to connect to.
- **Printing:** Configure settings for printer plug-ins installed on the device. You can search for available printers or add one manually to print files. Refer to [Printing](#) for more information.
- **VPN:** Set up virtual private networks (VPNs) on your device to connect to a private network.
- **Private DNS:** Set the device to use the security enhanced private DNS.
- **Ethernet:** When you connect an Ethernet adapter, you can use a wired network and configure network settings.

Printing

Configure settings for printer plug-ins installed on the device. You can connect the device to a printer via Wi-Fi or Wi-Fi Direct, and print images or documents.

 Some printers may not be compatible with the device.

Adding printer plug-ins

Add printer plug-ins for printers you want to connect the device to.



1 On the Settings screen, tap **Connections** → **More connection settings** → **Printing** → **Download plugin**.

2 Select a printer plug-in and install it.

3 Select the installed printer plug-in.

The device will automatically search for printers that are connected to the same Wi-Fi network as your device.

4 Select a printer to add.

 To add printers manually, tap  → **Add printer**.

Printing content

While viewing content, such as images or documents, access the options list, tap **Print** →  → **All printers...**, and then select a printer.

 Printing methods may vary depending on the content type.

Sounds and vibration

Options

Change settings for various sounds on the device.

On the Settings screen, tap **Sounds and vibration**.

- **Sound mode:** Set the device to use sound mode, vibration mode, or silent mode.
- **Vibrate while ringing:** Set the device to vibrate and play a ringtone for incoming calls.
- **Temporary mute:** Set the device to use silent mode for a certain period.
- **Ringtone:** Change the call ringtone.
- **Notification sound:** Change the notification sound.
- **System sound:** Change the sound to use for certain actions, such as charging the device.
- **Volume:** Adjust the device's volume level.
- **Vibration pattern:** Select a vibration pattern.
- **Vibration intensity:** Adjust the force of the vibration notification.
- **System sound/vibration control:** Set the device to sound or vibrate for actions, such as controlling the touchscreen.
- **Sound quality and effects:** Set the device's sound quality and effects. Refer to [Sound quality and effects](#) for more information.
- **Separate app sound:** Set the device to play media sound from a specific app separately on the other audio device. Refer to [Separate app sound](#) for more information.

Sound quality and effects

Set the device's sound quality and effects.

On the Settings screen, tap **Sounds and vibration** → **Sound quality and effects**.

- **Dolby Atmos:** Select a surround sound mode optimized for various types of audio, such as movies, music, and voice. With Dolby Atmos, you can experience moving audio sounds that flow all around you.
- **Dolby Atmos for gaming:** Experience the Dolby Atmos sound optimized for games while playing games.
- **Equalizer:** Select an option for a specific music genre and enjoy optimized sound.
- **UHQ upscaler:** Enhance the sound resolution of music and videos.
- **Adapt sound:** Set the best sound for you.

Separate app sound

Set the device to play media sound from a specific app on the connected Bluetooth speaker or headset.

For example, you can listen to the Navigation app through your device's speaker while listening to playback from the Music app through the vehicle's Bluetooth speaker.

- 1 On the Settings screen, tap **Sounds and vibration** → **Separate app sound** and tap the switch to activate it.
- 2 Select an app to play media sounds separately and tap the Back button.
- 3 Select a device for playing the selected app's media sound.

Notifications

Change the notification settings.

On the Settings screen, tap **Notifications**.

- **Suggest actions and replies:** Set the device to suggest actions and replies for notifications.
- **Swipe left or right for snooze:** Set the device to show the notification snooze icon when you swipe a notification to the left or right on the notification panel.
- **App icon badges:** Set the device to display a number or dot badge on apps that have notifications.
- **Status bar:** Set how to display notification icons and whether to show the remaining battery percentage on the status bar.
- **Do not disturb:** Set the device to mute all sounds except for allowed exceptions.
- **Recently sent:** View the apps that received recent notifications and change the notification settings. To customize notification settings for more apps, tap **See all** → ▼ → **All** and select an app from the apps list.

Display

Options

Change the display and the Home screen settings.

On the Settings screen, tap **Display**.

- **Light / Dark:** Activate or deactivate dark mode.
- **Dark mode settings:** Reduce eye strain by applying the dark theme when using the device at night or in a dark place. You can set a schedule for applying dark mode.
 The dark theme may not be applied in some apps.
- **Brightness:** Adjust the brightness of the display.
- **Adaptive brightness:** Set the device to keep track of your brightness adjustments and apply them automatically in similar lighting conditions.
- **Motion smoothness:** Change the refresh rate of the screen. When a high refresh rate is set, the screen will scroll more smoothly. Refer to [Motion smoothness \(Galaxy Note20 Ultra 5G, Note20 Ultra\)](#) for more information.
- **Blue light filter:** Reduce eye strain by limiting the amount of blue light emitted by the screen. You can set a schedule for applying the blue light filter.
- **Screen mode:** Change the screen mode to adjust the display's colour and contrast. Refer to [Changing the screen mode or adjusting the display colour](#) for more information.
- **Font size and style:** Change the font size and style.
- **Screen zoom:** Make the items on the screen larger or smaller.
- **Screen resolution:** Change the screen resolution. Higher resolutions make the display more vivid, however they will consume more battery power. Some currently running apps may close when you change the resolution.
- **Full screen apps:** Select apps to use with the full screen aspect ratio. You can also set the device to hide the front camera from the screen.
- **Screen timeout:** Set the length of time the device waits before turning off the display's backlight.
- **Home screen:** Configure settings for the Home screen, such as the screen layout.
- **Easy mode:** Switch to easy mode to display larger icons and apply a simpler layout to the Home screen.

- **Edge screen:** Change the settings for the Edge panel and the edge lighting.
- **Navigation bar:** Change the navigation bar settings. Refer to [Navigation bar \(soft buttons\)](#) for more information.
- **Accidental touch protection:** Set the device to prevent the screen from detecting touch input when it is in a dark place, such as a pocket or bag.
- **Touch sensitivity:** Increase the touch sensitivity of the screen for use with screen protectors.
- **Show charging information:** Set the device to display the charging information, such as the remaining battery percentage when the screen is off.
- **Screensaver:** Set the device to launch a screensaver when the device is charging.



Some features may not be available depending on the model.

Motion smoothness (Galaxy Note20 Ultra 5G, Note20 Ultra)

The refresh rate is the number of times the screen is refreshed every second. Use a high refresh rate to prevent the screen from flickering when switching between screens. The screen will scroll more smoothly. When you select a standard refresh rate, you can use the battery longer.

- 1 On the Settings screen, tap **Display** → **Motion smoothness**.
- 2 Select a refresh rate.
 - **Adaptive:** Get smoother animations and scrolling by automatically adjusting your screen refresh rate up to 120 Hz.
 - **Standard:** Use a standard refresh rate in normal situations to conserve battery power.

Changing the screen mode or adjusting the display colour

Change the screen mode or adjust the display colour to your preference.

Changing the screen mode

On the Settings screen, tap **Display** → **Screen mode** and select a mode you want.

- **Vivid:** This optimizes the colour range, saturation, and sharpness of your display. You can also adjust the display colour balance by colour value.
- **Natural:** This adjusts the screen to a natural tone.



- You can adjust the display colour only in **Vivid** mode.
- **Vivid** mode may not be compatible with third-party apps.
- You cannot change the screen mode while applying the blue light filter.

Optimizing the full screen colour balance

Optimize the display colour by adjusting the colour tones to your preference.

On the Settings screen, tap **Display** → **Screen mode** → **Vivid** and adjust the colour adjustment bar under **White balance**.

When you drag the colour adjustment bar towards **Cool**, the blue colour tone will increase. When you drag the bar towards **Warm**, the red colour tone will increase.

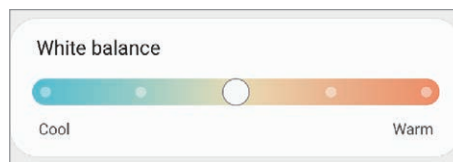

Adjusting the screen tone by colour value

Increase or lower certain colour tones by adjusting the Red, Green, or Blue value individually.

- 1 On the Settings screen, tap **Display** → **Screen mode** → **Vivid**.
- 2 Tap **Advanced settings**.
- 3 Adjust the **R** (Red), **G** (Green), or **B** (Blue) colour bar to your preference. The screen tone will be adjusted.

Wallpaper

Change the wallpaper settings for the Home screen and the locked screen.

On the Settings screen, tap **Wallpaper**.

Themes

Apply various themes to the device to change the visual elements of the Home screen, locked screen, and icons.

On the Settings screen, tap **Themes**.

Lock screen

Options

Change the settings for the locked screen.

On the Settings screen, tap **Lock screen**.

- **Screen lock type:** Change the screen lock method.
- **Smart Lock:** Set the device to unlock itself when trusted locations or devices are detected. Refer to [Smart Lock](#) for more information.
- **Secure lock settings:** Change screen lock settings for the selected lock method.
- **Always On Display:** Set the device to display information while the screen is turned off. Refer to [Always On Display](#) for more information.
- **Wallpaper services:** Set the device to use wallpaper services such as Dynamic Lock screen.
- **Clock style:** Change the type and colour of the clock on the locked screen.
- **Roaming clock:** Change the clock to show both the local and home time zones on the locked screen when roaming.
- **FaceWidgets:** Change the settings of the items displayed on the locked screen.
- **Contact information:** Set the device to show contact information, such as your email address, on the locked screen.

- **Notifications:** Set how to show notifications on the locked screen.
- **Shortcuts:** Select apps to display shortcuts to them on the locked screen.
- **About Lock screen:** View the Lock screen version and legal information.

 The available options may vary depending on the screen lock method selected.

Smart Lock

You can set the device to unlock itself and remain unlocked when trusted locations or devices are detected.

For example, if you have set your home as a trusted location, when you get home your device will detect the location and automatically unlock itself.

On the Settings screen, tap **Lock screen** → **Smart Lock** and follow the on-screen instructions to complete the setup.

-  • This feature will be available to use after you set a screen lock method.
- If you do not use your device for four hours or when you turn on the device, you must unlock the screen using the pattern, PIN, or password you set.

Always On Display

You can view information, such as the clock or calendar, or control music playback on the screen when it is turned off.

You can also check notifications for new messages or missed calls.

The Always On Display is set to appear only when you tap the screen. To change the settings to make it appear continuously or during a set time, on the Settings screen, tap **Lock screen** → **Always On Display**, and then select a mode you want.

 The brightness of the Always On Display may change automatically depending on the lighting conditions.

Opening notifications on the Always On Display

When you receive message, missed call, or app notifications, notification icons will appear on the Always On Display. Double-tap a notification icon to view its notification.

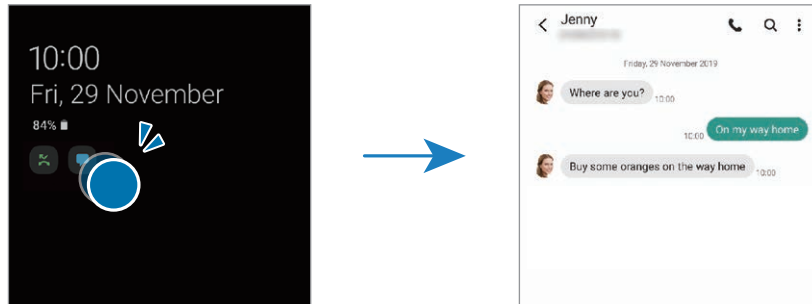

 If the screen is locked, you must unlock it to view notifications.

Deactivating the Always On Display feature

Open the notification panel, swipe downwards, and then tap  (Always On Display) to deactivate it. Alternatively, on the Settings screen, tap **Lock screen**, and then tap the **Always On Display** switch to deactivate it.

Biometrics and security

Options

Change the settings for securing the device.

On the Settings screen, tap **Biometrics and security**.

- **Face recognition:** Set the device to unlock the screen by recognizing your face. Refer to [Face recognition](#) for more information.
- **Fingerprints:** Register your fingerprints to unlock the screen. Refer to [Fingerprint recognition](#) for more information.
- **Biometrics preferences:** Change the settings for biometric data.
- **Biometrics security patch:** View the version of the biometrics security patch and check for updates.
- **Google Play Protect:** Set the device to check for harmful apps and behaviour, warn about potential harm, and remove them.

- **Security update:** View the version of your device's software and check for updates.
- **Find My Mobile:** Activate or deactivate the Find My Mobile feature. Access the Find My Mobile website (findmymobile.samsung.com) to track and control your lost or stolen device.
- **Samsung Pass:** Verify your identity easily and securely using your biometric data. Refer to [Samsung Pass](#) for more information.
- **Secure Folder:** Create a secure folder to protect your private content and apps from others. Refer to [Secure Folder](#) for more information.
- **Samsung Blockchain Keystore:** Manage your blockchain private key safely.
- **Install unknown apps:** Set the device to allow the installation of apps from unknown sources.
- **Encrypt or decrypt SD card:** Set the device to encrypt files on a memory card.
 - ❗ If you reset your device to the factory defaults with this setting enabled, the device will not be able to read your encrypted files. Disable this setting before resetting the device.
- **Other security settings:** Configure additional security settings.



Some features may not be available depending on the region, service provider, or model.

Face recognition

You can set the device to unlock the screen by recognizing your face.



- If you use your face as a screen lock method, your face cannot be used to unlock the screen for the first time after turning on the device. To use the device, you must unlock the screen using the pattern, PIN, or password you set when registering the face. Be careful not to forget your pattern, PIN, or password.
- If you change the screen lock method to **Swipe** or **None**, which are not secure, all of your biometric data will be deleted. If you want to use your biometric data in apps or features, you must register your biometric data again.

Precautions for using face recognition

Before using the face recognition to unlock your device, keep the following precautions in mind.

- Your device could be unlocked by someone or something that looks like your image.
- Face recognition is less secure than Pattern, PIN, or Password.

For better face recognition

Consider the following when using face recognition:

- Consider the conditions when registering, such as wearing glasses, hat, mask, beard, or heavy makeup
- Ensure that you are in a well-lit area and that the camera lens is clean when registering
- Ensure your image is not blurry for better match results

Registering your face

For better face registration, register your face indoors and out of direct sunlight.

- 1 On the Settings screen, tap **Biometrics and security** → **Face recognition**.
- 2 Read the on-screen instructions and tap **Continue**.
- 3 Set a screen lock method.
- 4 Select whether you are wearing glasses or not and tap **Continue**.
- 5 Position your face inside the frame on the screen.

The camera will scan your face.

-  • If unlocking the screen with your face is not working properly, tap **Remove face data** to remove your registered face and register your face again.
- To enhance the face recognition, tap **Add alternative look** and add an alternate appearance.

Unlocking the screen with your face

You can unlock the screen with your face instead of using a pattern, PIN, or password.

- 1 On the Settings screen, tap **Biometrics and security** → **Face recognition**.
- 2 Unlock the screen using the preset screen lock method.
- 3 Tap the **Face unlock** switch to activate it.

4 On the locked screen, look at the screen.

When your face is recognized, you can unlock the screen without using any additional screen lock method. If your face is not recognized, use the preset screen lock method.

Deleting the registered face data

You can delete face data that you have registered.

1 On the Settings screen, tap **Biometrics and security** → **Face recognition**.

2 Unlock the screen using the preset screen lock method.

3 Tap **Remove face data** → **Remove**.

Once the registered face is deleted, all the related features will also be deactivated.

Fingerprint recognition

In order for fingerprint recognition to function, your fingerprint information needs to be registered and stored in your device.



- This feature may not be available depending on the region or service provider.
- Fingerprint recognition uses the unique characteristics of each fingerprint to enhance the security of your device. The likelihood of the fingerprint sensor confusing two different fingerprints is very low. However, in rare cases where separate fingerprints are very similar the sensor may recognize them as identical.
- Your device comes with a screen protector attached. If you replace it, make sure the new protector allows for use of the ultrasonic fingerprint sensor. However, a screen protector may not be attached depending on the region or service provider.
- If you use your fingerprint as a screen lock method, your fingerprint cannot be used to unlock the screen for the first time after turning on the device. To use the device, you must unlock the screen using the pattern, PIN, or password you set when registering the fingerprint. Be careful not to forget your pattern, PIN, or password.
- If your fingerprint is not recognized, unlock the device using the pattern, PIN, or password you set when registering the fingerprint, and then re-register your fingerprints. If your pattern, PIN, or password is forgotten, you will not be able to use the device if you do not reset it. Samsung is not responsible for any data loss or inconvenience caused by forgotten unlock codes.
- If you change the screen lock method to **Swipe** or **None**, which are not secure, all of your biometric data will be deleted. If you want to use your biometric data in apps or features, you must register your biometric data again.

For better fingerprint recognition

When you scan your fingerprints on the device, be aware of the following conditions that may affect the feature's performance:

- The device may not recognize fingerprints that are affected by wrinkles or scars.
- The device may not recognize fingerprints from small or thin fingers.
- To improve recognition performance, register fingerprints of the hand used most often to perform tasks on the device.
- Your device has a built-in fingerprint recognition sensor at the bottom centre of the screen. Ensure that the screen protector or the touchscreen on the fingerprint recognition sensor area is not scratched or damaged by objects, such as coins, keys, pens, and necklaces.
- Ensure that the fingerprint recognition sensor area at the bottom centre of the screen and your fingers are clean and dry.
- If you bend your finger or use a fingertip, the device may not recognize your fingerprints. Press the screen so that your fingertip spreads over the wide surface of the fingerprint recognition area.

Registering fingerprints

- 1 On the Settings screen, tap **Biometrics and security** → **Fingerprints**.
- 2 Read the on-screen instructions and tap **Continue**.
- 3 Set a screen lock method.
- 4 Place your finger on the fingerprint recognition sensor. After the device detects your finger, lift it up and place it on the fingerprint recognition sensor again. Repeat this action until the fingerprint is registered.

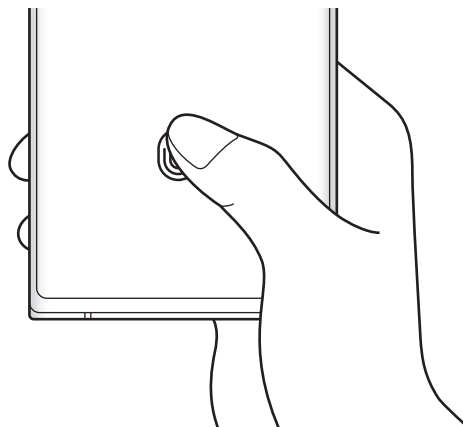

- 5 When you are finished registering your fingerprints, tap **Done**.
You can check whether your fingerprint is registered by tapping **Check added fingerprints**.

Unlocking the screen with your fingerprints

You can unlock the screen with your fingerprint instead of using a pattern, PIN, or password.

- 1 On the Settings screen, tap **Biometrics and security** → **Fingerprints**.
- 2 Unlock the screen using the preset screen lock method.
- 3 Tap the **Fingerprint unlock** switch to activate it.
- 4 On the locked screen, place your finger on the fingerprint recognition sensor and scan your fingerprint.

Changing the fingerprint recognition icon setting

Set the device to show or hide the fingerprint recognition icon when you tap the screen while the screen is turned off.

- 1 On the Settings screen, tap **Biometrics and security** → **Fingerprints**.
- 2 Unlock the screen using the preset screen lock method.
- 3 Tap **Show icon when screen is off** and select an option.

Deleting registered fingerprints

You can delete registered fingerprints.

- 1 On the Settings screen, tap **Biometrics and security** → **Fingerprints**.
- 2 Unlock the screen using the preset screen lock method.
- 3 Select a fingerprint to delete and tap **Remove**.

Samsung Pass

Register your biometric data to Samsung Pass and easily verify your identity when using services which require your login or personal information.



- The website sign-in feature is only available for websites that you access via the **Internet** app. Some websites may not support this feature.
- Registered biometric data and saved payment card information are only saved to your device and are not synced with other devices or servers.

Registering Samsung Pass

Before using Samsung Pass, register your biometric data to Samsung Pass.

On the Settings screen, tap **Biometrics and security** → **Samsung Pass**. Follow the on-screen instructions to complete the setup.

Verifying the Samsung account password

You can use your registered biometric data to verify your identity instead of entering your Samsung account password when, for example, you purchase content from **Galaxy Store**.

On the Samsung Pass main screen, tap  → **Settings** → **Account and syncing**, and then tap the **Verify with Samsung Pass** switch to activate it.

Using Samsung Pass to sign in to websites

You can use Samsung Pass to easily sign in to websites that support ID and password autofill.

- 1 On the sign-in page of the website, enter your ID and password, and then tap the website's sign-in button.
- 2 When a pop-up window asking whether you want to save the sign-in information appears, tick **Sign in with Samsung Pass** and tap **Remember**.

Using Samsung Pass to sign in to apps

You can use Samsung Pass to easily sign in to apps that support ID and password autofill.

- 1 On the sign-in page of the app, enter your ID and password, and then tap the app's sign-in button.
- 2 When a pop-up window asking whether you want to save the sign-in information appears, tap **Save**.

Managing sign-in information

View the list of websites and apps you have set to use Samsung Pass and manage your sign-in information.

- 1 On the Samsung Pass main screen, tap **Sign-in** and select a website or app from the list.
- 2 Tap **Edit** and modify your ID, password, and the website's or app's name.
To delete your sign-in information, tap **Delete**.

Using Samsung Pass with websites and apps

When using websites or apps that support Samsung Pass, you can easily sign in with Samsung Pass.

To see the list of websites and apps that support Samsung Pass, on the Samsung Pass main screen, tap  → **Partners**. If there are no websites or apps that support Samsung Pass, **Partners** will not appear.



- Available websites and apps may vary depending on the region or service provider.
- Samsung is not responsible for any loss or inconvenience caused by signing in to websites or apps via Samsung Pass.

Entering your personal information automatically

You can use Samsung Pass to easily enter your personal information, such as your address or payment card information, on apps that support autofill.

- 1 On the Samsung Pass main screen, tap **Autofill forms** and select an option.
- 2 Enter the information and tap **Save**.
You can now use the biometric data you registered to Samsung Pass when entering the personal information automatically on supported apps.

Deleting your Samsung Pass data

You can delete your biometric data, sign-in information, and app data registered to Samsung Pass.

On the Samsung Pass main screen, tap  → **Settings** → **Delete data**.



- Your agreement to the terms and conditions and your Samsung account will remain active.
- The Samsung Pass data on other devices signed in to your Samsung account will not be deleted.

Secure Folder

Secure Folder protects your private content and apps, such as photos and contacts, from being accessed by others. You can keep your private content and apps secure even when the device is unlocked.

- ❗ Secure Folder is a separate, secured storage area. The data in Secure Folder cannot be transferred to other devices via unapproved sharing methods, such as USB or Wi-Fi Direct. Attempting to customize the operating system or modifying software will cause Secure Folder to be automatically locked and inaccessible. Before saving data in Secure Folder, make sure to back up a copy of the data in another secure location.

Setting up Secure Folder

- 1 Launch the **Settings** app and tap **Biometrics and security** → **Secure Folder**.
- 2 Follow the on-screen instructions to complete the setup.
The Secure Folder screen will appear and the Secure Folder app icon (📁) will be added to the Apps screen.
To change the name or icon colour of Secure Folder, tap ⋮ → **Customize**.

- 📁 • When you launch the **Secure Folder** app, you must unlock the app using your preset lock method.
- If you forget your Secure Folder unlock code, you can reset it using your Samsung account. Tap the button at the bottom of the locked screen, and enter your Samsung account password.

Setting an auto lock condition for Secure Folder

- 1 Launch the **Secure Folder** app and tap ⋮ → **Settings** → **Auto lock Secure Folder**.
- 2 Select a lock option.

- 📁 To manually lock your Secure Folder, tap ⋮ → **Lock and exit**.

Moving content to Secure Folder

Move content, such as photos and videos, to Secure Folder. The following actions are an example of moving an image from the default storage to Secure Folder.

- 1 Launch the **Secure Folder** app and tap **Add files**.
- 2 Tap **Images**, tick images to move, and then tap **Done**.
- 3 Tap **Move**.
The selected items will be deleted from the original folder and moved to Secure Folder. To copy items, tap **Copy**.



The method for moving content may vary depending on the content type.

Moving content from Secure Folder

Move content from Secure Folder to the corresponding app in the default storage. The following actions are an example of moving an image from Secure Folder to the default storage.

- 1 Launch the **Secure Folder** app and tap **Gallery**.
- 2 Select an image and tap **⋮** → **Move out of Secure Folder**.
The selected items will be moved to **Gallery** in the default storage.

Adding apps

Add an app to use in Secure Folder.

- 1 Launch the **Secure Folder** app and tap **Add apps**.
- 2 Tick one or more apps installed on the device and tap **Add**.

Removing apps from Secure Folder

Tap and hold an app to delete, and tap **Uninstall**.

Adding accounts

Add your Samsung and Google accounts, or other accounts, to sync with the apps in Secure Folder.

- 1 Launch the **Secure Folder** app and tap **⋮** → **Settings** → **Accounts** → **Add account**.
- 2 Select an account service.
- 3 Follow the on-screen instructions to complete the account setup.

Hiding Secure Folder

You can hide the Secure Folder shortcut from the Apps screen.

Launch the **Secure Folder** app, tap  → **Settings**, and then tap the **Show icon on Apps screen** switch to deactivate it.

Alternatively, open the notification panel, swipe downwards, and then tap  (**Secure Folder**) to deactivate the feature.

If you want to show the Secure Folder again, launch the **Settings** app, tap **Biometrics and security** → **Secure Folder**, and then tap the **Show icon on Apps screen** switch to activate it.

Backing up and restoring Secure Folder

Back up content and apps in Secure Folder to Samsung Cloud using your Samsung account and restore them later.

Launch the **Secure Folder** app and tap  → **Settings** → **Backup and restore**.

Uninstalling Secure Folder

You can uninstall Secure Folder, including the content and apps in it.

Launch the **Secure Folder** app and tap  → **Settings** → **More settings** → **Uninstall**.

To back up content before uninstalling Secure Folder, tick **Move media files out of Secure Folder** and tap **Uninstall**. To access data backed up from Secure Folder, launch the **My Files** app and tap **Internal storage** → **Secure Folder**.



Notes saved in **Samsung Notes** will not be backed up.

Privacy

Change the settings for privacy.

On the Settings screen, tap **Privacy**.

- **Permission manager:** View the list of features and apps that have permission to use them. You can also edit the permission settings.
- **Send diagnostic data:** Set the device to automatically send the device's diagnostic and usage information to Samsung.
- **Receive marketing information:** Set whether to receive Samsung marketing information, such as special offers, membership benefits, and newsletters.
- **Samsung account privacy:** Manage personal data related to your Samsung account and change the settings for Customization Service.

- **Advanced:** Configure advanced settings for privacy.



Some features may not be available depending on the region.

Location

Change settings for location information permissions.

On the Settings screen, tap **Location**.

- **App permissions:** View the list of apps that have permission to access the device's location and edit the permission settings.
- **Improve accuracy:** Set the device to use the Wi-Fi or Bluetooth feature to increase the accuracy of your location information, even when the features are deactivated.
- **Recent location requests:** View which apps request your current location information.
- **Location services:** View the location services your device is using.

Accounts and backup

Options

Sync, back up, or restore your device's data using Samsung Cloud. You can also sign in to accounts, such as your Samsung account or Google account, or transfer data to or from other devices via Smart Switch.

On the Settings screen, tap **Accounts and backup**.

- **Accounts:** Add your Samsung and Google accounts, or other accounts, to sync with.
- **Backup and restore:** Keep your personal information, app data, and settings safe on your device. You can back up your sensitive information and access it later. You must sign in to your Google or Samsung account to back up or restore data.
- **Samsung Cloud:** Manage the content that you want to store securely in Samsung Cloud. Sync and back up your data and settings, and restore the previous device's data and settings even when you do not have it. Refer to [Settings](#) for more information.
- **Smart Switch:** Launch Smart Switch and transfer data from your previous device. Refer to [Transferring data from your previous device \(Smart Switch\)](#) for more information.



Regularly back up your data to a safe location, such as Samsung Cloud or a computer, so that you can restore it if the data is corrupted or lost due to an unintended factory data reset.

Samsung Cloud

Sync your device's data with Samsung Cloud and view the data you have synced in each app. You can also back up your device's data to Samsung Cloud and restore it later.

Syncing data

You can sync data saved in your device with Samsung Cloud and access it from other devices.

1 On the Settings screen, tap **Accounts and backup** → **Samsung Cloud**.

2 Tap  → **Settings** → **Sync and auto backup settings** → **Sync**.

3 Tap the switches next to the items you want to sync with.

 When you connect your Samsung account and Microsoft account, you can sync images and videos with Microsoft OneDrive.

Backing up data

You can back up your device's data to Samsung Cloud.

1 On the Settings screen, tap **Accounts and backup** → **Samsung Cloud** → **Back up this phone**.

2 Tick items you want to back up and tap **Back up**.

3 Tap **Done**.

 • Some data will not be backed up. To check which data will be backed up, on the Settings screen, tap **Accounts and backup** → **Samsung Cloud** → **Back up this phone**.

• To view the backup data for other devices in your Samsung Cloud, on the Settings screen, tap **Accounts and backup** → **Samsung Cloud** → **Restore data** → , and then select a device you want.

Restoring data

You can restore your backup data from Samsung Cloud to your device.

1 On the Settings screen, tap **Accounts and backup** → **Samsung Cloud**.

2 Tap **Restore data** →  and select a device you want.

3 Tick items you want to restore and tap **Restore**.

Google

Configure settings for some features provided by Google.

On the Settings screen, tap **Google**.

Advanced features

Options

Activate advanced features and change the settings that control them.

On the Settings screen, tap **Advanced features**.

- **S Pen:** Change the settings for using the S Pen. Refer to [S Pen](#) for more information.
- **Side key:** Select an app or feature to launch using the Side key. Refer to [Setting the Side key](#) for more information.
- **Bixby Routines:** Add routines to automate settings that you use repeatedly. The device also suggests useful routines according to your frequent situations. Refer to [Bixby Routines](#) for more information.
- **Call & text on other devices:** Use your device's calling and messaging features on other devices signed in to your Samsung account.
- **Link to Windows:** Instantly access data saved in your device on your computer. Refer to [Link to Windows](#) for more information.
- **Smart pop-up view:** Select apps to view their notifications via pop-up windows. When using this feature, you can quickly view the contents via pop-up windows by tapping the icon on the screen.
- **Screenshots and screen recorder:** Change the settings for screenshots and screen recorder.
- **Direct share:** Set the device to display the people you contacted on the sharing options panel to allow you to share content directly.
- **Reduce animations:** Set the device to reduce the screen effects of certain actions, such as opening or closing apps.
- **Motions and gestures:** Activate the motion feature and configure settings. Refer to [Motions and gestures](#) for more information.

- **One-handed mode:** Activate one-handed operation mode for your convenience when using the device with one hand.
- **Game Launcher:** Activate the Game Launcher. Refer to [Game Launcher](#) for more information.
- **Dual Messenger:** Install a second copy of a messenger app and use two separate accounts for the same app. Refer to [Dual Messenger](#) for more information.
- **Video enhancer:** Enhance the image quality of your videos to enjoy brighter and more vivid colours.



This feature may not be available in some apps.

- **Send SOS messages:** Set the device to send help messages by pressing the Side key several times.



Some features may not be available depending on the region or service provider.

Motions and gestures

Activate the motion feature and configure settings.

On the Settings screen, tap **Advanced features** → **Motions and gestures**.

- **Lift to wake:** Set the device to turn on the screen when you pick it up.
- **Double tap to wake:** Set the device to turn on the screen by double-tapping anywhere on the screen while the screen is turned off.
- **Smart stay:** Set the device to prevent the display from turning off while you are looking at it.
- **Smart alert:** Set the device to alert you if you have missed calls or new messages when you pick up the device.



This feature may not work if the screen is turned on or the device is not on a flat surface.

- **Easy mute:** Set the device to mute certain sounds by using motions or gestures.
- **Palm swipe to capture:** Set the device to capture a screenshot when you swipe your hand to the left or right across the screen. You can view the captured images in **Gallery**.



It is not possible to capture a screenshot while using some apps and features.

- **Swipe to call or send messages:** Set the device to make a call or send a message when you swipe to the right or left on a contact or a phone number in the **Phone** or **Contacts** app.



Excessive shaking or an impact to the device may cause an unintended input for some features using sensors.

Dual Messenger

Install a second copy of a messenger app and use two separate accounts for the same app.

- 1 On the Settings screen, tap **Advanced features** → **Dual Messenger**.
Supported apps will appear.
- 2 Tap the switch of an app to install the second copy.
The second app will be installed. The second app's icon will be displayed with .



-  • The Dual Messenger feature may not be available depending on the app.
- Some features of the app may be limited for the second app.

Uninstalling a second app

- 1 On the Settings screen, tap **Advanced features** → **Dual Messenger**.
- 2 Tap the switch of the app you want to uninstall and tap **Uninstall**.
All data related to the second app will be deleted.

-  If you uninstall the first app, the second app will also be deleted.

Digital Wellbeing and parental controls

View the history of your device usage and use features to prevent your device from interfering with your life. You can also set up parental controls for your children and manage their digital use.

On the Settings screen, tap **Digital Wellbeing and parental controls**.

- **Screen time:** Set goals for how much you use your device a day.
- **Unlocks:** Set goals for how many times you unlock your device a day.
- **App timers:** Limit the daily usage time for each app by setting a timer. When you reach the limit, the app will be deactivated and you cannot use it.
- **Focus mode:** Activate focus mode to avoid distractions from your device and stay focused on what you want. You can use the apps you allowed to be used in focus mode.

- **Wind Down:** Activate wind down mode to reduce eye strain before sleeping and prevent your sleep from being disturbed.
- **Volume monitor:** Activate the volume monitor to protect your hearing.
- **Parental controls:** Manage your children's digital use.

Device care

Introduction

The device care feature provides an overview of the status of your device's battery, storage, memory, and system security. You can also automatically optimize the device with a tap of your finger.

Optimizing your device

On the Settings screen, tap **Device care** → **Optimize now**.

The quick optimization feature improves device performance through the following actions:

- Closing apps running in the background.
- Managing abnormal battery usage.
- Scanning for crashed apps and malware.

Using the auto optimization feature

You can set the device to perform auto optimization when your device is not in use. Tap  → **Advanced** → **Auto optimization** and tap the switch to activate it. If you want to set the time to perform auto optimization, tap **Time**.

Battery

Check the remaining battery power and time to use the device. For devices with low battery levels, conserve battery power by activating power saving features.

On the Settings screen, tap **Device care** → **Battery**.

- **Battery usage:** View your battery usage and put apps to sleep when they are not being used. Select apps from the apps list and tap the **Put app to sleep** switch to activate it.
- **Power mode:** Select a power mode, such as power saving mode.
- **App power management:** Limit battery usage for apps that you do not use often.

- **Wireless PowerShare:** Charge another device with your device's battery. Refer to [Wireless PowerShare](#) for more information.
 - **Charging:** Set the device to charge the battery more quickly. Refer to [Quick charging](#) for more information.
-  • The usage time left shows the time remaining before the battery power runs out. Usage time left may vary depending on your device settings and operating conditions.
- You may not receive notifications from some apps that use power saving mode.

Storage

Check the status of the used and available storage space.

On the Settings screen, tap **Device care** → **Storage**. To delete files or uninstall apps that you do not use any more, select a category. Then, tick items to select and tap **Delete** or **Uninstall**

-  • The actual available capacity of the internal memory is less than the specified capacity because the operating system and default apps occupy part of the space. The available capacity may change when you update the device.
- You can view the available capacity of the internal storage in the Specification section for your device on the Samsung website.

Memory

On the Settings screen, tap **Device care** → **Memory**.

To speed up your device by stopping apps running in the background, tick apps from the apps list, and tap **Clean now**.

Security

Check the device's security status. This feature scans your device for malware.

On the Settings screen, tap **Device care** → **Security** → **Scan phone**.

Apps

Manage the device's apps and change their settings. You can view the apps' usage information, change their notification or permission settings, or uninstall or disable unnecessary apps.

On the Settings screen, tap **Apps**.

General management

Customize your device's system settings or reset the device.

On the Settings screen, tap **General management**.

- **Language and input:** Select device languages and change settings, such as keyboards and voice input types. Some options may not be available depending on the selected language. Refer to [Adding device languages](#) for more information.
- **Date and time:** Access and alter the settings to control how the device displays the time and date.
 If the battery remains fully discharged, the time and date is reset.
- **Contact us:** Ask questions or view frequently asked questions.
- **Reset:** Reset your device's settings or perform a factory data reset. You can reset all your settings, or only network settings, or accessibility settings. You can also set the device to restart at a preset time for device optimization.

Adding device languages

You can add languages to use on your device.

1 On the Settings screen, tap **General management** → **Language and input** → **Language** → **Add language**.

To view all the languages that can be added, tap  → **All languages**.

2 Select a language to add.

- 3 To set the selected language as the default language, tap **Set as default**. To keep the current language setting, tap **Keep current**.

The selected language will be added to your languages list. If you changed the default language, the selected language will be added to the top of the list.

To change the default language from your languages list, select the language you want and tap **Apply**. If an app does not support the default language, the next supported language in the list will be used.

Accessibility

Configure various settings to improve accessibility to the device. Refer to [Accessibility](#) for more information.

On the Settings screen, tap **Accessibility**.

Software update

Update your device's software via the firmware over-the-air (FOTA) service. You can also schedule software updates.

On the Settings screen, tap **Software update**.

- **Download and install:** Check for and install updates manually.
- **Auto download over Wi-Fi:** Set the device to download updates automatically when connected to a Wi-Fi network.
- **Last update:** View information about the last software update.

 If emergency software updates are released for your device's security and to block new types of security threats, they will be installed automatically without your agreement.

Security updates information

Security updates are provided to strengthen the security of your device and protect your personal information. For security updates for your model, visit security.samsungmobile.com.

 The website supports only some languages.

About phone

Access your device's information.

On the Settings screen, tap **About phone**.

To change your device's name, tap **Edit**.

- **Status:** View various device information, such as the SIM card status, Wi-Fi MAC address, and serial number.
- **Legal information:** View legal information related to the device, such as safety information and the open source licence.
- **Software information:** View the device's software information, such as its operating system version and firmware version.
- **Battery information:** View the device's battery status and information.

Appendix

Accessibility

About Accessibility

Improve accessibility with features that make the device easier to use for users who have impaired vision, hearing, and reduced dexterity.

Launch the **Settings** app and tap **Accessibility**. You can check the accessibility feature you are using at the top of the screen. Tap  to view features you are currently using or tap **Turn off** to disable the features quickly.

Voice Assistant (Voice feedback)

Activating or deactivating Voice Assistant

When you activate Voice Assistant, the device will start voice feedback. When you tap the selected feature once, the device will read the text on the screen aloud. Tapping the feature twice will activate the feature.

Launch the **Settings** app, tap **Accessibility** → **Screen reader**, tap the **Voice Assistant** switch, tap **Allow**, and then tap the selected area twice to activate the feature.

To deactivate Voice Assistant, tap the switch and tap anywhere on the screen twice quickly.

To view how to use Voice Assistant, tap **Tutorial**.

 Some features are not available while you are using Voice Assistant.

Controlling the screen with finger gestures

You can use various finger gestures to control the screen while you are using Voice Assistant.

One finger gestures

- Tap: Read aloud the item under your finger. To explore the screen, place a finger on the screen and move it on the screen.
- Tap twice: Open the selected item. While selected items are read aloud, when you hear the item you want, release your finger from the item. Then, tap anywhere on the screen twice quickly.
- Double-tap and hold the screen: Move an item or access an available option.
- Swipe to the left: Read the previous item.
- Swipe to the right: Read the next item.
- Swipe upwards or downwards: Change the most recent contextual menu settings.
- Swipe to the left then right in one motion: Scroll up the screen.
- Swipe to the right then left in one motion: Scroll down the screen.
- Swipe upwards then downwards in one motion: Move to the first item on the screen.
- Swipe downwards then upwards in one motion: Move to the last item on the screen.

Two finger gestures

- Tap twice: Start, pause, or resume the current action.
- Tap three times: Check the current time, remaining battery power, and more. To change items that are read aloud, launch the **Settings** app and tap **Accessibility** → **Screen reader** → **Settings** → **Status bar information**.
- Tap four times: Activate or deactivate voice feedback.
- Swipe to the left: Move to the next page.
- Swipe to the right: Return to the previous page.
- Swipe upwards: Scroll down the list.
- Swipe downwards: Scroll up the list.
- Swipe upwards or downwards on the Home screen: Open the Apps screen.
- Swipe upwards or downwards on the Apps screen: Return to the Home screen.
- Swipe in any direction on the locked screen: Unlock the screen.
- Swipe downwards from the top of the screen: Open the notification panel.

Three finger gestures

- Tap: Start reading items aloud from the top.
- Tap twice: Start reading from the next item.
- Tap three times: Read the last selected text and copy it to the clipboard.
- Swipe to the left or right: Open the contextual menu and scroll through the options.
- Swipe upwards or downwards: Change the text reading and selecting granularity.
- Swipe upwards then downwards in one motion: Return to the previous screen.
- Swipe downwards then upwards in one motion: Return to the Home screen.

Four finger gestures

- Tap: Return to the previous screen.
- Tap twice: Return to the Home screen.
- Tap three times: Open the list of recent apps.

Using the contextual menu

While you are using Voice Assistant, swipe to the left or right with three fingers. The contextual menu will appear and the device will read the options aloud. Swipe to the left or right with three fingers to scroll through the options. When you hear the option you want, swipe upwards or downwards to use the option or adjust the settings for the option. For example, when you hear **Speech rate**, you can adjust the speech rate by swiping upwards or downwards.

Adding and managing image labels

You can assign labels to images on the screen. The device reads the labels aloud when the images are selected. Add labels to unlabelled images by tapping the screen twice with three fingers and holding.

To manage the labels, launch the **Settings** app and tap **Accessibility** → **Screen reader** → **Settings** → **Manage custom labels**.

Configuring settings for Voice Assistant

Configure settings for Voice Assistant for your convenience.

Launch the **Settings** app and tap **Accessibility** → **Screen reader** → **Settings**.

- **Text-to-speech:** Change the settings for text-to-speech features used when Voice Assistant is activated, such as languages, speed, and more.
- **Verbosity:** Customize the detailed settings for voice feedback.
- **Shake for continuous reading:** Set the device to read aloud the text displayed on the screen when you shake the device. You can select from various shaking intensity.
- **Speak passwords:** Set the device to read the characters aloud when you enter your password.
- **Read caller ID aloud:** Set the device to read the caller's name aloud when you have an incoming call.
- **Vibration feedback:** Set the device to vibrate when you control the screen, such as selecting an item.
- **Sound feedback:** Set the device to emit a sound when you control the screen, such as selecting an item. You can also adjust the volume of the sound played when you touch the screen to control it.
- **Focus on speech audio:** Set the device to turn the media volume down when the device reads an item aloud.
- **Focus indicator:** Set the device to thicken the border of the focus indicator that appears when you tap items. You can also change the colour of the indicator.
- **Single-tap activation:** Set the device to activate the selected item with a single tap.
- **Single-tap navigation bar:** Set the device to use the buttons on the navigation bar with a single tap.
- **Quick menu:** Select contextual menu options to display when you swipe to the left or right with three fingers.
- **Manage custom labels:** Manage the labels you added.
- **Enhanced focus:** Set the device to move the focus to the starting or previous position when changing screens.
- **Keyboard shortcuts:** Set key shortcuts to use when using an external keyboard.
- **Light sensing:** Set the device to let you know when it detects light.

- **Dark screen with Side key:** Set the device to function normally with the screen off.
- **Status bar information:** Select items to read aloud when you tap the screen three times with two fingers.
- **Developer options:** Set options for app development.

Using the device with the screen turned off

For privacy, you can set the device to function normally with the screen off. The screen will not turn on when you press keys or tap the screen. Currently activated features do not turn off when the screen is off.

Launch the **Settings** app, tap **Accessibility** → **Screen reader** → **Settings**, and then tap the **Dark screen with Side key** switch to activate it. You can activate or deactivate this feature by pressing the Side key twice quickly.

 This feature will appear only when Voice Assistant has been activated.

Entering text using the keyboard

To display the keyboard, tap the text input field, and then tap anywhere on the screen twice quickly.

To activate the rapid key input feature, launch the **Settings** app, tap **Accessibility** → **Screen reader**, and then tap the **Quick typing** switch to activate it.

When you touch the keyboard with your finger, the device reads aloud the character keys under your finger. When you hear the character you want, release your finger from the screen to select it. The character is entered and the device reads the text aloud.

If **Quick typing** is not activated, release your finger from the character you want, and then tap anywhere on the screen twice quickly.

 This feature will appear only when Voice Assistant has been activated.

Entering additional characters

Tap and hold a key on the keyboard to enter additional characters available for the key. A pop-up window appears above the key showing available characters. To select a character, drag your finger on the pop-up window until you hear the character you want, and release it.

Visibility enhancements

Using the high contrast theme

Apply a clear theme that displays light-coloured content on a dark background.

Launch the **Settings** app, tap **Accessibility** → **Visibility enhancements** → **High contrast theme**, and then select a theme you want.

Using the high contrast font

Adjust the colour and outline of fonts to increase the contrast between the text and the background.

Launch the **Settings** app, tap **Accessibility** → **Visibility enhancements**, and then tap the **High contrast fonts** switch to activate it.

Using the high contrast keyboard

Change the colours of the Samsung keyboard to increase the contrast between the text and the background.

Launch the **Settings** app, tap **Accessibility** → **Visibility enhancements**, and then tap the **High contrast keyboard** switch to activate it.

Displaying button shapes

Display button shapes with frames to make them stand out.

Launch the **Settings** app, tap **Accessibility** → **Visibility enhancements**, and then tap the **Show button shapes** switch to activate it.

Reversing the display colours

Improve screen visibility to help users recognize text on the screen more easily.

Launch the **Settings** app, tap **Accessibility** → **Visibility enhancements**, and then tap the **Colour inversion** switch to activate it.

Colour adjustment

Adjust how colours are displayed on the screen if you have difficulty distinguishing colours. The device changes the colours into more recognizable colours.

Launch the **Settings** app, tap **Accessibility** → **Visibility enhancements** → **Colour adjustment**, and then tap the switch to activate it. Select an option.

To adjust the intensity of colour, drag the adjustment bar under **Intensity**.

If you select **Personalized colour**, you can personalize the colour of the screen. Follow the on-screen instructions to complete the colour adjustment procedure.

Colour lens

Adjust the screen colours if you have difficulty in reading the text.

Launch the **Settings** app, tap **Accessibility** → **Visibility enhancements** → **Colour lens**, and then tap the switch to activate it. Select a colour you want.

To adjust the transparency level, drag the adjustment bar under **Opacity**.

Reducing screen motion effects

Reduce animation effects if you are sensitive to animations or screen movement.

Launch the **Settings** app, tap **Accessibility** → **Visibility enhancements**, and then tap the **Remove animations** switch to activate it.

Using a magnifier

Activate a magnifier to zoom in on the screen to view a larger version of the content.



Launch the **Settings** app, tap **Accessibility** → **Visibility enhancements**, and then tap the **Magnifier window** switch to activate it. The magnifier will appear on the screen.

Drag the edge of the magnifier frame to move the magnifier to where you want to zoom in on the screen.

Magnifying the screen

Magnify the screen and zoom in on a specific area.

Launch the **Settings** app and tap **Accessibility** → **Visibility enhancements** → **Magnification**.

- **Triple tap screen to magnify:** Zoom in by tapping the screen three times. To return to the normal view, tap the screen three times again.
- **Use shortcut to magnify:** Zoom in by tapping  on the navigation bar, and then tapping where you want to magnify the screen. To return to the normal view, tap .

To explore the screen, drag two or more fingers across the magnified screen.

To adjust zoom ratio, pinch two or more fingers on the magnified screen or spread them apart.

You can also temporarily magnify the screen by tapping the screen three times and holding. Or, tap , and then tap and hold the screen. While holding the screen, drag your finger to explore the screen. Release your finger to return to the normal view.

-  • Keyboards and the navigation bar on the screen cannot be magnified.
- When this feature is activated, the performance of some apps may be affected.

Enlarging mouse or touchpad pointers

Enlarge the pointer when using an external mouse or touchpad.

Launch the **Settings** app, tap **Accessibility** → **Visibility enhancements**, and then tap the **Large mouse/touchpad pointer** switch to activate it.

Changing font

Change the font size and style.

Launch the **Settings** app and tap **Accessibility** → **Visibility enhancements** → **Font size and style**.

Changing screen zoom

Make the items on the screen larger or smaller.

Launch the **Settings** app and tap **Accessibility** → **Visibility enhancements** → **Screen zoom**.

Hearing enhancements

Hearing aid support

Set the device to enhance the sound quality to work better with hearing aids.

Launch the **Settings** app, tap **Accessibility** → **Hearing enhancements** → **Hearing aid support**, and then tap the **Hearing aid compatibility** switch to activate it.

Amplify ambient sound

Set the device to amplify the sound around you to help you hear better when using an earphone.

- 1 Launch the **Settings** app, tap **Accessibility** → **Hearing enhancements** → **Amplify ambient sound**, and then tap the switch to activate it.
- 2 Connect an earphone to the device and wear it.
- 3 Tap .

Adapt sound

Optimize the sound setting to find the best sound quality and use it for calls or media playback.

Launch the **Settings** app, tap **Accessibility** → **Hearing enhancements** → **Adapt sound**, and then optimize the sound setting.

Adjusting the sound balance

Set the device to adjust the sound balance.

- 1 Launch the **Settings** app and tap **Accessibility** → **Hearing enhancements**.
- 2 Drag the adjustment bar under **Left/right sound balance** to the left or right and adjust the sound balance.

Mono audio

Mono output combines stereo sound into one signal that is played through all earphone speakers. Use this if you have a hearing impairment or if a single earbud is more convenient.

Launch the **Settings** app, tap **Accessibility** → **Hearing enhancements**, and then tap the **Mono audio** switch to activate it.

Turning off all sounds

Set the device to mute all device sounds, such as media sounds, and the caller's voice during a call.

Launch the **Settings** app, tap **Accessibility** → **Hearing enhancements**, and then tap the **Mute all sounds** switch to activate it.

Live Transcribe

Set the device to capture speech using the device's microphone and convert it to on-screen text.

Launch the **Settings** app, tap **Accessibility** → **Hearing enhancements** → **Live Transcribe**, and then tap the switch to activate it. Then, tap  to transcribe speech.

Live Caption

Set the device to detect speech and automatically generate captions when you play media content, such as videos or podcasts.

Launch the **Settings** app, tap **Accessibility** → **Hearing enhancements** → **Live Caption**, and then tap the **Live Caption** switch to activate it.

Caption settings

Launch the **Settings** app, tap **Accessibility** → **Hearing enhancements** → **Subtitle settings** → **Samsung subtitles (CC)** or **Google subtitles (CC)**, and then tap the switch to activate it.

Select an option for configuring the caption settings.

Sound detectors

Set the device to detect a baby crying or your doorbell. The device will vibrate when it detects sound and the alert will be saved as a log.



While this feature is enabled, the voice recognition will not operate.

Baby crying detector

Launch the **Settings** app and tap **Accessibility** → **Hearing enhancements** → **Sound detectors** → **Baby crying detector** → **Start**.

Doorbell detector

- 1 Launch the **Settings** app and tap **Accessibility** → **Hearing enhancements** → **Sound detectors** → **Doorbell detector**.
- 2 Tap **Record** to make a recording of your doorbell.
The device will detect and record the doorbell.
- 3 Tap **Test** and ring your doorbell to check if it is recorded correctly. When the device detects the doorbell sound, tap **Start**.
To change the doorbell sound, tap **Change doorbell sound**.

Interaction and dexterity

Universal switch

You can control the touchscreen by connecting an external switch, by tapping the screen, or by using head movements and face gestures.

- 1 Launch the **Settings** app and tap **Accessibility** → **Interaction and dexterity** → **Universal switch**.
 - 2 Read the on-screen instructions and tap **Done**.
 - 3 Tap the switch to activate it.
 - 4 If the universal switches are not registered on the device, tap **Add switch** and set switches to control the device.
-  To activate the universal switch feature, at least one switch must be registered on the device.

To set switches to control the device, tap the switch under **Switches**.

To deactivate this feature, press the Side key and the Volume Up key simultaneously.

Assistant menu

Displaying the assistive shortcut icon

Set the device to display the assistive shortcut icon for accessing apps, features, and settings. You can easily control the device by tapping the assistive menus in the icon.

- 1 Launch the **Settings** app and tap **Accessibility** → **Interaction and dexterity** → **Assistant menu**.
- 2 Tap the switch to activate it.
The assistive shortcut icon appears at the bottom right of the screen.
To adjust the assistant shortcut icon's transparency level, drag the adjustment bar under **Transparency**.

Accessing assistive menus







The assistive shortcut icon appears as a floating icon for easy access to the assistive menus from any screen.

When you tap the assistive shortcut icon, the icon expands slightly and the assistive menus appear on the icon. Tap the left or right arrow to move to other panels or swipe to the left or right to select other menus.

Using the cursor

On the assistive menu, tap **Cursor**. You can control the screen using small finger movements on the touch area. Drag your finger on the touch area to move the cursor. Also, tap the screen to select items under the cursor.

Use the following options:

-  : Scroll left or right on the screen.
-  : Scroll up or down the screen.
-  : Magnify the area where the cursor is located.
-  : Change the touchpad and cursor settings.
-  : Move the touch area to another location.
-  : Close the touch area.

Using enhanced assistive menus

Set the device to display enhanced assistive menus for selected apps.

Launch the **Settings** app, tap **Accessibility** → **Interaction and dexterity** → **Assistant menu** → **Assistant plus**, and then tap the switches next to the apps you want to activate.

Answering or ending calls

Change the method for answering or ending calls.

Launch the **Settings** app, tap **Accessibility** → **Interaction and dexterity** → **Answering and ending calls**, and then tap the switch of the method you want.

Interaction control

Activate interaction control mode to restrict the device's reaction to inputs while using apps.

- 1 Launch the **Settings** app and tap **Accessibility** → **Interaction and dexterity** → **Interaction control**.
- 2 Tap the switch to activate it.
- 3 Press and hold the Side key and the Volume Up key simultaneously while using an app.
- 4 Adjust the size of the frame or draw a line around an area that you want to restrict.
- 5 Tap **Done**.

The device displays the restricted area. The restricted area will not react when you touch it and the device's keys will be disabled. However, you can enable functions for the Side key, Volume key, and keyboard in interaction control mode.

To deactivate interaction control mode, press and hold the Side key and the Volume Up key simultaneously.

To set the device to lock the screen after deactivating interaction control mode, launch the **Settings** app, tap **Accessibility** → **Interaction and dexterity** → **Interaction control**, and then tap the **Lock screen when deactivated** switch to activate it.

Touch and hold delay

Set the recognition time for tapping and holding the screen.

Launch the **Settings** app, tap **Accessibility** → **Interaction and dexterity** → **Touch and hold delay**, and then select an option.

Tap duration

Set the duration you must touch the screen for the device to recognize it as a tap.

Launch the **Settings** app, tap **Accessibility** → **Interaction and dexterity** → **Tap duration**, tap the switch to activate it, and then set the time.

Ignore repeated touches

Set the device to recognize only the first tap within a set time when you tap the screen repeatedly.

Launch the **Settings** app, tap **Accessibility** → **Interaction and dexterity** → **Ignore repeated touches**, tap the switch to activate it, and then set the time.

Click after pointer stops

Set the device to select an item automatically when you place the mouse pointer over the item.

Launch the **Settings** app, tap **Accessibility** → **Interaction and dexterity**, and then tap the **Click after pointer stops** switch to activate it.

Sticky keys

Set an external keyboard's modifier key, such as the Shift, Ctrl, or Alt keys, to stay pressed. This helps you use keyboard shortcuts without pressing two keys at the same time.

Launch the **Settings** app, tap **Accessibility** → **Interaction and dexterity**, and then tap the **Sticky keys** switch to activate it.

Slow keys

Set the recognition time for pressing a key on the external keyboard.

Launch the **Settings** app, tap **Accessibility** → **Interaction and dexterity** → **Slow keys**, tap the switch to activate it, and then set the time.

Bounce keys

Set the device to recognize only the first time you press a key within a set time when you press the same key repeatedly.

Launch the **Settings** app, tap **Accessibility** → **Interaction and dexterity** → **Bounce keys**, tap the switch to activate it, and then set the time.

Advanced settings

Launching accessibility features quickly

Set to open accessibility features quickly.

Launch the **Settings** app, tap **Accessibility** → **Advanced settings** → **Side and Volume up keys**, and then tap the switch to activate it. Then, select an accessibility feature to open when you simultaneously press the Side key and the Volume Up key.

You can access the following accessibility features:

- Accessibility
- Voice Assistant
- Universal switch
- Magnifier window
- Colour inversion
- Colour adjustment
- Colour lens
- High contrast fonts
- Mute all sounds
- Interaction control

Launching the shortcut services quickly

Set to start a shortcut service quickly.

Launch the **Settings** app, tap **Accessibility** → **Advanced settings** → **Volume up and down keys**, and then tap the switch to activate it. Then, tap **Selected service** and select a shortcut service to start when you simultaneously press and hold the Volume Up key and the Volume Down key for three seconds.

You can access the following shortcut services:

- Live Transcribe
- Your Phone Companion
- Universal switch
- Voice Assistant

Setting light notification

Set the device to blink the flash or the screen when an alarm sounds or when you have notifications, such as incoming calls or new messages.

Launch the **Settings** app, tap **Accessibility** → **Advanced settings** → **Flash notification**, and then tap the switches next to the options you want to activate.

Notification reminders

Set the device to alert you to notifications that you have not checked at the interval.

Launch the **Settings** app, tap **Accessibility** → **Advanced settings** → **Notification reminders**, and then tap the switch to activate it.

- **Vibrate when sound plays:** Set the device to vibrate and play a notification sound when you have unchecked notifications.
- **Remind every:** Set an interval between alerts.
- **Select apps:** Set apps to alert you to notifications.

Time to take action

Set the amount of time to display pop-up windows that ask you to take action, such as notifications or volume controller.

Launch the **Settings** app, tap **Accessibility** → **Advanced settings** → **Time to take action**, and then select an option.

Adding voice recordings to voice labels

You can use voice labels to distinguish objects of similar shape by attaching labels to them. You can record and assign a voice recording to an NFC-enabled voice label. The voice recording is played back when you place your device near the label.





 Turn on the NFC feature before using this feature.

- 1 Launch the **Settings** app and tap **Accessibility** → **Advanced settings** → **Voice Label**. The voice recorder will launch.
- 2 Tap  to start recording. Speak into the microphone.

- 3 When you are finished recording, tap **Done** to stop.
- 4 Hold the back of your device over the voice label.
The information in the voice recording will be written to the voice label.

Bixby Vision for accessibility

When you activate the Bixby Vision accessibility features, you can use additional Bixby Vision features.

- 1 Launch the **Settings** app, tap **Accessibility** → **Advanced settings** → **Bixby Vision for accessibility**, and then tap the switch to activate it.
- 2 Tap **Open Bixby Vision**.
- 3 Select a feature you want to use.
 -  : Analyze the scene you captured and describe it by voice.
 -  : Recognize objects and describe them by voice.
 -  : Recognize text and read them aloud.
 -  : Detect the colour of the object and say it aloud.

 Available features may vary depending on the region.

Installed services

View accessibility services installed on the device.

Launch the **Settings** app and tap **Accessibility** → **Installed services**.

Troubleshooting

Before contacting a Samsung Service Centre, please attempt the following solutions. Some situations may not apply to your device.

You can also use Samsung Members to solve any problems you might encounter while using your device.

When you turn on your device or while you are using the device, it prompts you to enter one of the following codes:

- **Password:** When the device lock feature is enabled, you must enter the password you set for the device.
- **PIN:** When using the device for the first time or when the PIN requirement is enabled, you must enter the PIN supplied with the SIM or USIM card. You can disable this feature by using the Lock SIM card menu.
- **PUK:** Your SIM or USIM card is blocked, usually as a result of entering your PIN incorrectly several times. You must enter the PUK supplied by your service provider.
- **PIN2:** When you access a menu requiring the PIN2, you must enter the PIN2 supplied with the SIM or USIM card. For more information, contact your service provider.

Your device displays network or service error messages

- When you are in areas with weak signals or poor reception, you may lose reception. Move to another area and try again. While moving, error messages may appear repeatedly.
- You cannot access some options without a subscription. For more information, contact your service provider.

Your device does not turn on

When the battery is completely discharged, your device will not turn on. Fully charge the battery before turning on the device.

The touchscreen responds slowly or improperly

- If you attach a screen protector or optional accessories to the touchscreen, the touchscreen may not function properly.
- If you are wearing gloves, if your hands are not clean while touching the touchscreen, or if you tap the screen with sharp objects or your fingertips, the touchscreen may malfunction.
- The touchscreen may malfunction in humid conditions or when exposed to water.
- Restart your device to clear any temporary software bugs.
- Ensure that your device software is updated to the latest version.
- If the touchscreen is scratched or damaged, visit a Samsung Service Centre.

Your device freezes or encounters a fatal error

Try the following solutions. If the problem is still not resolved, contact a Samsung Service Centre.

Restarting the device

If your device freezes or hangs, you may need to close apps or turn off the device and turn it on again.

Forcing restart

If your device is frozen and unresponsive, press and hold the Side key and the Volume Down key simultaneously for more than 7 seconds to restart it.

Resetting the device

If the methods above do not solve your problem, perform a factory data reset.

Launch the **Settings** app and tap **General management** → **Reset** → **Factory data reset** → **Reset** → **Delete all**. Before performing the factory data reset, remember to make backup copies of all important data stored in the device.

Calls are not connected

- Ensure that you have accessed the right cellular network.
- Ensure that you have not set call barring for the phone number you are dialing.
- Ensure that you have not set call barring for the incoming phone number.

Others cannot hear you speaking on a call

- Ensure that you are not covering the built-in microphone.
- Ensure that the microphone is close to your mouth.
- If using an earphone, ensure that it is properly connected.

Sound echoes during a call

Adjust the volume by pressing the Volume key or move to another area.

A cellular network or the Internet is often disconnected or audio quality is poor

- Ensure that you are not blocking the device's internal antenna.
- When you are in areas with weak signals or poor reception, you may lose reception. You may have connectivity problems due to issues with the service provider's base station. Move to another area and try again.
- When using the device while moving, wireless network services may be disabled due to issues with the service provider's network.

The battery does not charge properly (For Samsung-approved chargers)

- Ensure that the charger is connected properly.
- Visit a Samsung Service Centre and have the battery replaced.

The battery depletes faster than when first purchased

- When you expose the device or the battery to very cold or very hot temperatures, the useful charge may be reduced.
- Battery consumption will increase when you use certain features or apps, such as GPS, games, or the Internet.
- The battery is consumable and the useful charge will get shorter over time.

Error messages appear when launching the camera

Your device must have sufficient available storage and battery power to operate the camera app. If you receive error messages when launching the camera, try the following:

- Charge the battery.
- Free some space by transferring files to a computer or deleting files from your device.
- Restart the device. If you are still having trouble with the camera app after trying these tips, contact a Samsung Service Centre.

Photo quality is poorer than the preview

- The quality of your photos may vary, depending on the surroundings and the photography techniques you use.
- If you take photos in dark areas, at night, or indoors, image noise may occur or images may be out of focus.

Error messages appear when opening multimedia files

If you receive error messages or multimedia files do not play when you open them on your device, try the following:

- Free some space by transferring files to a computer or deleting files from your device.
- Ensure that the music file is not Digital Rights Management (DRM)-protected. If the file is DRM-protected, ensure that you have the appropriate licence or key to play the file.
- Ensure that the file formats are supported by the device. If a file format is not supported, such as DivX or AC3, install an app that supports it. To confirm the file formats that your device supports, visit the Samsung website.
- Your device supports photos and videos captured with the device. Photos and videos captured by other devices may not work properly.
- Your device supports multimedia files that are authorized by your network service provider or providers of additional services. Some content circulated on the Internet, such as ringtones, videos, or wallpapers, may not work properly.

Bluetooth is not working well

If another Bluetooth device is not located or there are connection problems or performance malfunctions, try the following:

- Ensure that the device you wish to connect with is ready to be scanned or connected to.
- Ensure that your device and the other Bluetooth device are within the maximum Bluetooth range (10 m).
- On your device, launch the **Settings** app, tap **Connections**, and then tap the **Bluetooth** switch to re-activate it.
- On your device, launch the **Settings** app, tap **General management** → **Reset** → **Reset network settings** → **Reset settings** → **Reset** to reset network settings. You may lose registered information when performing the reset.

If the tips above do not solve the problem, contact a Samsung Service Centre.

The screen brightness adjustment bar does not appear on the notification panel

Open the notification panel by dragging the status bar downwards, and then drag the notification panel downwards. Tap  → **Quick panel layout** and tap the **Show brightness on top** switch to activate it.

A connection is not established when you connect the device to a computer

- Ensure that the USB cable you are using is compatible with your device.
- Ensure that you have the proper driver installed and updated on your computer.

Your device cannot find your current location

GPS signals may be obstructed in some locations, such as indoors. Set the device to use Wi-Fi or a mobile network to find your current location in these situations.

Data stored in the device has been lost

Always make backup copies of all important data stored in the device. Otherwise, you cannot restore data if it is corrupted or lost. Samsung is not responsible for the loss of data stored in the device.

A small gap appears around the outside of the device case

- This gap is a necessary manufacturing feature and some minor rocking or vibration of parts may occur.
- Over time, friction between parts may cause this gap to expand slightly.

There is not enough space in the device's storage

Delete unnecessary data, such as cache, using the device care feature or manually delete unused apps or files to free up storage space.

The Home button does not appear

The navigation bar containing the Home button may disappear while using certain apps or features. To view the navigation bar, drag upwards from the bottom of the screen.

Removing the battery

- **To remove the battery, contact an authorized service centre.**
- For your safety, you **must not attempt to remove** the battery. If the battery is not properly removed, it may lead to damage to the battery and device, cause personal injury, and/or result in the device being unsafe.
- Samsung does not accept liability for any damage or loss (whether in contract or tort, including negligence) which may arise from failure to precisely follow these warnings and instructions, other than death or personal injury caused by Samsung's negligence.

Health and Safety

Please read this important safety information before you use the device. It contains general safety information for devices and may include content that does not apply to your device. Follow the warning and caution information to prevent injury to yourself or others and to prevent damage to your device.



The term 'device' refers to the product and its battery, charger, the items supplied with the product, and any Samsung-approved accessories used with the product.



Warning: Failure to comply with safety warnings and regulations can cause serious injury or death.

Do not use damaged power cords or plugs, or loose electrical sockets

Unsecured connections can cause electric shock or fire.

Do not touch the device, power cords, plugs, or the electric socket with wet hands or other wet body parts

Doing so may cause electric shock.

Do not pull the power cord excessively when disconnecting it

Doing so may cause electric shock or fire.

Do not bend or damage the power cord

Doing so may cause electric shock or fire.

Do not use the device with wet hands while the device is charging

Doing so may cause electric shock.

Do not directly connect together the charger's positive and negative terminals

Doing so may cause fire or serious injury.

Do not use your device outdoor during a thunderstorm

Doing so may result in electric shock or device malfunction.

Use manufacturer-approved batteries, chargers, accessories, and supplies

- Using generic batteries or chargers may shorten the life of your device or cause the device to malfunction. They may also cause a fire or cause the battery to explode.
- Use only a Samsung-approved battery and charger specifically designed for your device. An incompatible battery or charger can cause serious injuries or damage to your device.
- Samsung cannot be responsible for the user's safety when using accessories or supplies that are not approved by Samsung.

Do not carry your device in your back pockets or on your waist

- The device may be damaged, explode, or result in a fire if too much pressure is applied to it.
- You may be injured if you are bumped or fall.

Do not drop or cause an impact to the charger or the device

Handle and dispose of the device and charger with care

- Never dispose of the battery or device in a fire. Never place the battery or device on or in heating devices, such as microwave ovens, stoves, or radiators. The device may explode when overheated. Follow all local regulations when disposing of used battery or device.
- Never crush or puncture the device.
- Avoid exposing the device to high external pressure, which can lead to an internal short circuit and overheating.

Protect the device, battery and charger from damage

- Avoid exposing your device and battery to very cold or very hot temperatures.
- Extreme temperatures can damage the device and reduce the charging capacity and life of your device and battery.
- Do not directly connect together the battery's positive and negative terminals and prevent them from coming into contact with metal objects. Doing so may cause the battery to malfunction.
- Never use a damaged charger or battery.

Do not store your device near or in heaters, microwaves, hot cooking equipment, or high pressure containers

- The battery may leak.
- Your device may overheat and cause a fire.

Do not use or store your device in areas with high concentrations of dust or airborne materials

Dust or foreign materials can cause your device to malfunction and may result in fire or electric shock.

Prevent the multipurpose jack and the small end of the charger from contact with conductive materials, such as liquids, dust, metal powders, and pencil leads. Do not touch the multipurpose jack with sharp tools or cause an impact to the multipurpose jack

Conductive materials may cause a short circuit or corrosion of the terminals, which may result in an explosion or fire.

When using the wireless charger, do not place foreign materials, such as metal objects, magnets, and magnetic stripe cards, between the device and the wireless charger

The device may not charge properly or may overheat.

Do not bite or suck the device or the battery

- Doing so may damage the device or result in an explosion or fire.
- Children or animals can choke on small parts.
- If children use the device, make sure that they use the device properly.

Do not insert the device or supplied accessories into the eyes, ears, or mouth

Doing so may cause suffocation or serious injuries.

Do not handle a damaged or leaking Lithium Ion (Li-Ion) battery

For safe disposal of your Li-Ion battery, contact your nearest authorized service centre.

⚠ Caution: Failure to comply with safety cautions and regulations can cause injury or property damage

Do not use your device near other electronic devices

- Most electronic devices use radio frequency signals. Your device may interfere with other electronic devices.
- Using an LTE data connection may cause interference with other devices, such as audio equipment and telephones.

Do not use your device in a hospital, on an aircraft, or in automotive equipment that can be interfered with by radio frequency

- Avoid using your device within a 15 cm range of a pacemaker, if possible, as your device can interfere with the pacemaker.
- To minimize possible interference with a pacemaker, use your device only on the side of your body that is opposite the pacemaker.
- If you use medical equipment, contact the equipment manufacturer before using your device to determine whether or not the equipment will be affected by radio frequencies emitted by the device.
- On an aircraft, using electronic devices can interfere with the aircraft's electronic navigational instruments. Make sure the device is turned off during takeoff and landing. After takeoff, you can use the device in flight mode if allowed by aircraft personnel.
- Electronic devices in your car may malfunction due to radio interference from your device. Contact the manufacturer for more information.

Do not expose the device to heavy smoke or fumes

- Doing so may damage the outside of the device or cause it to malfunction.

If you use a hearing aid, contact the manufacturer for information about radio interference

The radio frequency emitted by your device may interfere with some hearing aids. Before using your device, contact the manufacturer to determine whether or not your hearing aid will be affected by radio frequencies emitted by the device.

Do not use your device near devices or apparatuses that emit radio frequencies, such as sound systems or radio towers

Radio frequencies may cause your device to malfunction.

Turn off the device in potentially explosive environments

- Turn off your device in potentially explosive environments instead of removing the battery.
- Always comply with regulations, instructions and signs in potentially explosive environments.
- Do not use your device at refuelling points (gas stations), near fuels or chemicals, or in blasting areas.
- Do not store or carry flammable liquids, gases, or explosive materials in the same compartment as the device, its parts, or accessories.

If you notice strange smells or sounds coming from your device or the battery, or if you see smoke or liquids leaking from the device or battery, stop using the device immediately and take it to a Samsung Service Centre

Failure to do so may result in fire or explosion.

Comply with all safety warnings and regulations regarding mobile device usage while operating a vehicle

While driving, safely operating the vehicle is your first responsibility. Never use your mobile device while driving, if it is prohibited by law. For your safety and the safety of others, use your common sense and remember the following tips:

- Get to know your device and its convenience features, such as speed dial and redial. These features help you reduce the time needed to place or receive calls on your mobile device.
- Position your device within easy reach. Make sure you can access your wireless device without taking your eyes off the road. If you receive an incoming call at an inconvenient time, let your voicemail answer it for you.
- Suspend use in heavy traffic or hazardous weather conditions. Rain, sleet, snow, ice, and heavy traffic can be hazardous.

- Do not take notes or look up phone numbers. Jotting down a “to do” list or flipping through your address book takes attention away from your primary responsibility of driving safely.
- Dial sensibly and assess the traffic. Place calls when you are not moving or before pulling into traffic. Try to plan calls when your car will be stationary.
- Do not engage in stressful or emotional conversations that may be distracting. Make the person you are talking to aware that you are driving and suspend conversations that could potentially divert your attention from the road.

Care for and use your mobile device properly

Keep your device dry

- Humidity and liquids may damage the parts or electronic circuits in your device.
- Do not turn on your device if it is wet. If your device is already on, turn it off and remove the battery immediately (if the device will not turn off or you cannot remove the battery, leave it as-is). Then, dry the device with a towel and take it to a service centre.
- This device has internal liquid indicators fitted. Water damage to your device may void the manufacturer’s warranty.

Store your device only on flat surfaces

- If your device falls, it may be damaged.

The device can be used in locations with an ambient temperature of 0°C to 35°C. You can store the device at an ambient temperature of -20°C to 50°C. Using or storing the device outside of the recommended temperature ranges may damage the device or reduce the battery’s lifespan

- Do not store your device in very hot areas such as inside a car in the summer. Doing so may cause the screen to malfunction, result in damage to the device, or cause the battery to explode.
- Do not expose your device to direct sunlight for extended periods of time (on the dashboard of a car, for example).
- For a device with a removable battery, the battery can be stored separately in locations with an ambient temperature of 0 °C to 45 °C.

Do not store your device with metal objects, such as coins, keys, and necklaces

- Your device may be scratched or may malfunction.
- If the battery terminals come into contact with metal objects, this may cause a fire.

Do not store your device near magnetic fields

- Your device may malfunction or the battery may discharge from exposure to magnetic fields.
- Magnetic stripe cards, including credit cards, phone cards, passbooks, and boarding passes, may be damaged by magnetic fields.

Prolonged exposure of your skin to an overheated device may cause low temperature burn symptoms, such as red spots and pigmentation

Do not use your device with the back cover removed

The battery may fall out of the device, which may result in damage or malfunction.

If your device has a camera flash or light, do not use it close to the eyes of people or pets

Using a flash close to the eyes may cause temporary loss of vision or damage to the eyes.

Use caution when exposed to flashing lights

- While using your device, leave some lights on in the room and do not hold the screen too close to your eyes.
- Seizures or blackouts can occur when you are exposed to flashing lights while watching videos or playing Flash-based games for extended periods. If you feel any discomfort, stop using the device immediately.
- If anyone related to you has experienced seizures or blackouts while using a similar device, consult a physician before using the device.
- If you feel discomfort, such as a muscle spasm, or disoriented, stop using the device immediately and consult a physician.
- To prevent eye strain, take frequent breaks while using the device.

Reduce the risk of repetitive motion injuries

When you repetitively perform actions, such as pressing keys, drawing characters on a touch screen with your fingers, or playing games, you may experience occasional discomfort in your hands, neck, shoulders, or other parts of your body. When using your device for extended periods, hold the device with a relaxed grip, press the keys lightly, and take frequent breaks. If you continue to have discomfort during or after such use, stop using the device and consult a physician.

Protect your hearing and ears when using a headset



- Excessive exposure to loud sounds can cause hearing damage.
 - Exposure to loud sounds while walking may distract your attention and cause an accident.
 - Always turn the volume down before plugging the earphones into an audio source and use only the minimum volume setting necessary to hear your conversation or music.
-
- In dry environments, static electricity can build up in the headset. Avoid using headsets in dry environments or touch a metal object to discharge static electricity before connecting a headset to the device.
 - Do not use a headset while driving or riding. Doing so may distract your attention and cause an accident, or may be illegal, depending on your region.

Use caution when using the device while walking or moving

- Always be aware of your surroundings to avoid injury to yourself or others.
- Make sure the headset cable does not become entangled in your arms or on nearby objects.

Do not paint or put stickers on your device

- Paint and stickers can clog moving parts and prevent proper operation.
- If you are allergic to paint or metal parts of the device, you may experience itching, eczema, or swelling of the skin. When this happens, stop using the device and consult your physician.

Do not use the device if the screen is cracked or broken

- Broken glass or acrylic could cause injury to your hands and face. Take the device to a Samsung Service Centre to have it repaired.

Install mobile devices and equipment with caution

- Ensure that any mobile devices or related equipment installed in your vehicle are securely mounted.
- Avoid placing your device and accessories near or in an airbag deployment area. Improperly installed wireless equipment can cause serious injury when airbags inflate rapidly.

Do not drop your device or cause impacts to your device

- Your device may be damaged or may malfunction.
- If bent or deformed, your device may be damaged or parts may malfunction.

Ensure maximum battery and charger life

- Batteries may malfunction if they are not used for extended periods.
- Over time, unused device will discharge and must be recharged before use.
- Disconnect the charger from power sources when not in use.
- Use the battery only for its intended purpose.
- Follow all instructions in this manual to ensure the longest lifespan of your device and battery. Damage or poor performance caused by failure to follow warnings and instructions can void your manufacturer's warranty.
- Your device may wear out over time. Some parts and repairs are covered by the warranty within the validity period, but damages or deterioration caused by using unapproved accessories are not.

When using the device, mind the following

- Hold the device upright, as you would with a traditional phone.
- Speak directly into the microphone.

Do not disassemble, modify, or repair your device

- Any changes or modifications to your device can void your manufacturer's warranty. If your device needs servicing, take your device to a Samsung Service Centre.
- Do not disassemble or puncture the battery, as this can cause explosion or fire.
- Turn off the device before removing the battery. If you remove the battery with the device turned on, it may cause the device to malfunction.

When cleaning your device, mind the following

- Wipe your device or charger with a towel or an eraser.
- Clean the battery terminals with a cotton ball or a towel.
- Do not use chemicals or detergents. Doing so may discolour or corrode the outside the device or may result in electric shock or fire.

Do not use the device for anything other than its intended use

- Your device may malfunction.

Avoid disturbing others when using the device in public

Allow only qualified personnel to service your device

- Allowing unqualified personnel to service your device may result in damage to your device and will void your manufacturer's warranty.

Handle SIM cards, memory cards and cables with care

- When inserting a card or connecting a cable to your device, make sure that the card is inserted or the cable is connected to the proper side.
- Do not remove a card while the device is transferring or accessing information, as this could result in loss of data and/or damage to the card or device.
- Protect cards from strong shocks, static electricity, and electrical noise from other devices.
- Do not touch gold-coloured contacts or terminals with your fingers or metal objects. If dirty, wipe the card with a soft cloth.
- Inserting a card or connecting a cable by force or improperly may result in damage to the multipurpose jack or other parts of the device.

Ensure access to emergency services

Emergency calls from your device may not be possible in some areas or circumstances. Before travelling in remote or undeveloped areas, plan an alternative method of contacting emergency services personnel.

Protect your personal data and prevent leakage or misuse of sensitive information

- While using your device, be sure to back up important data. Samsung is not responsible for the loss of any data.
- When disposing of your device, back up all data and then reset your device to prevent misuse of your personal information.
- Carefully read the permissions screen when downloading applications. Be particularly cautious with applications that have access to many functions or to a significant amount of your personal information.
- Check your accounts regularly for unapproved or suspicious use. If you find any sign of misuse of your personal information, contact your service provider to delete or change your account information.
- In the event your device is lost or stolen, change the passwords on your accounts to protect your personal information.
- Avoid using applications from unknown sources and lock your device with a pattern, password, or PIN.

Do not distribute copyright-protected material

Do not distribute copyright-protected material without the permission of the content owners. Doing this may violate copyright laws. The manufacturer is not liable for any legal issues caused by the user's illegal use of copyrighted material.

Malware and viruses

To protect your device from malware and viruses, follow these usage tips. Failure to do so may result in damages or loss of data that may not be covered by the warranty service

- Do not download unknown applications.
- Do not visit untrusted websites.
- Delete suspicious messages or email from unknown senders.
- Set a password and change it regularly.
- Deactivate wireless features, such as Bluetooth, when not in use.
- If the device behaves abnormally, run an antivirus program to check for infection.
- Run an antivirus program on your device before you launch newly-downloaded applications and files.
- Install antivirus programs on your computer and run them regularly to check for infection.
- Do not edit registry settings or modify the device's operating system.

Acknowledging Special Precautions and ISED (Innovation, Science and Economic Development Canada) Notice

Cautions

Any changes or modifications to your device not expressly approved in this document could void your warranty for this equipment, and void your authority to operate this equipment. Only use approved batteries, antennas, and chargers. The use of any unauthorized accessories may be dangerous and void the phone warranty if they cause damage or a defect to the device.

Although your device is quite sturdy, it is a complex piece of equipment and can be broken. Avoid dropping, hitting, bending, or sitting on it.

Information to User

This equipment has been tested and found to comply with the limits of a Class B digital device. These limits are designed to provide reasonable protection against harmful interference in a residential installation. This equipment generates, uses, and can radiate radio frequency energy and, if not installed and used in accordance with the instructions, may cause harmful interference to radio communications. However, there is no guarantee that interference will not occur in a particular installation; if this equipment does cause harmful interference to radio or television reception, which can be determined by turning the equipment off and on, the user is encouraged to try to correct the interference by one or more of the following measures:

- Reorient/relocate the receiving antenna.
- Increase the separation between the equipment and receiver.
- Connect the equipment into an outlet on a circuit different from that to which the receiver is connected.
- Consult the dealer or an experienced radio/TV technician for help.

 **Warning:** At very high volumes, prolonged listening to a headset can damage your hearing.

Specific Absorption Rates (SAR) for Wireless Devices

The SAR is a value that corresponds to the relative amount of RF energy absorbed by the user of a wireless device.

The SAR value of a device is the result of an extensive testing, measuring and calculation process. It does not represent how much RF the device emits. All devices are tested at their highest value in strict laboratory settings. But when in operation, the SAR of a device can be substantially less than the level reported to ISED. This is because of a variety of factors including its proximity to a base station antenna, design and other factors. What is important

to remember is that each device meets strict federal guidelines. Variations in SARs do not represent a variation in safety.

All devices must meet the federal standard, which incorporates a substantial margin of safety. As stated above, variations in SAR values between different model devices do not mean variations in safety. SAR values at or below the federal standard of 1.6 W/kg are considered safe for use by the public.

SAR values are measured in positions that simulate uses against the head and held to the ear. SAR values for body-worn operations refer to accessories (i.e. device case and device holster) that contains no metal at a minimum distance of 1.5 cm from the body.

Correct disposal of this product (Waste Electrical & Electronic Equipment)



This marking on the product, accessories or literature indicates that the product and its electronic accessories (e.g., charger, headset, USB cable) should not be disposed of with other household waste.

To prevent possible harm to the environment or human health from uncontrolled waste disposal, please separate these items from other types of waste and recycle them responsibly to promote the sustainable reuse of material resources.

Household users should contact either the retailer where they purchased this product, or their local government office, for details of where and how they can take these items for environmentally safe recycling.

Business users should contact their supplier and check the terms and conditions of the purchase contract. This product and its electronic accessories should not be mixed with other commercial wastes for disposal.

This product is RoHS compliant.

Correct disposal of batteries in this product

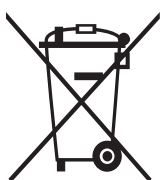

This marking on the battery, manual or packaging indicates that the batteries in this product should not be disposed of with other household waste at the end of their working life. Where marked, the chemical symbols Hg, Cd or Pb indicate that the battery contains mercury, cadmium or lead above the reference levels in EC Directive 2006/66.

Disclaimer

Some content and services accessible through this device belong to third parties and are protected by copyright, patent, trademark and/or other intellectual property laws. Such content and services are provided solely for your personal non-commercial use. You may not use any content or services in a manner that has not been authorized by the content owner or service provider. Without limiting the foregoing, unless expressly authorized by the applicable content owner or service provider, you may not modify, copy, republish, upload, post, transmit, translate, sell, create derivative works, exploit, or distribute in any manner or medium any content or services displayed through this device.

“THIRD PARTY CONTENT AND SERVICES ARE PROVIDED “AS IS.” SAMSUNG DOES NOT WARRANT CONTENT OR SERVICES SO PROVIDED, EITHER EXPRESSLY OR IMPLIED, FOR ANY PURPOSE. SAMSUNG EXPRESSLY DISCLAIMS ANY IMPLIED WARRANTIES, INCLUDING BUT NOT LIMITED TO, WARRANTIES OF MERCHANTABILITY OR FITNESS FOR A PARTICULAR PURPOSE. SAMSUNG DOES NOT GUARANTEE THE ACCURACY, VALIDITY, TIMELINESS, LEGALITY, OR COMPLETENESS OF ANY CONTENT OR SERVICE MADE AVAILABLE THROUGH THIS DEVICE AND UNDER NO CIRCUMSTANCES, INCLUDING NEGLIGENCE, SHALL SAMSUNG BE LIABLE, WHETHER IN CONTRACT OR TORT, FOR ANY DIRECT, INDIRECT, INCIDENTAL, SPECIAL OR CONSEQUENTIAL DAMAGES, ATTORNEY FEES, EXPENSES, OR ANY OTHER DAMAGES ARISING OUT OF, OR IN CONNECTION WITH, ANY INFORMATION CONTAINED IN, OR AS A RESULT OF THE USE OF ANY CONTENT OR SERVICE BY YOU OR ANY THIRD PARTY, EVEN IF ADVISED OF THE POSSIBILITY OF SUCH DAMAGES.”

Third party services may be terminated or interrupted at any time, and Samsung makes no representation or warranty that any content or service will remain available for any period of time. Content and services are transmitted by third parties by means of networks and transmission facilities over which Samsung has no control. Without limiting the generality of this disclaimer, Samsung expressly disclaims any responsibility or liability for any interruption or suspension of any content or service made available through this device.

Samsung is neither responsible nor liable for customer service related to the content and services. Any question or request for service relating to the content or services should be made directly to the respective content and service providers.

Technical requirements for Wi-Fi operation in the 5 GHz band

Wi-Fi access points that are capable of allowing your device to operate in the 5.15 - 5.25 GHz band are optimized for indoor use only. If your Wi-Fi network is capable of operating in this mode, please restrict your Wi-Fi use to indoors to not violate federal regulations to protect mobile satellite services.

Copyright

Copyright © 2020 Samsung Electronics Co., Ltd.

This manual is protected under international copyright laws.

No part of this manual may be reproduced, distributed, translated, or transmitted in any form or by any means, electronic or mechanical, including photocopying, recording, or storing in any information storage and retrieval system.

Trademarks

- SAMSUNG and the SAMSUNG logo are registered trademarks of Samsung Electronics Co., Ltd.
- Bluetooth® is a registered trademark of Bluetooth SIG, Inc. worldwide.
- Wi-Fi®, Wi-Fi Direct™, Wi-Fi CERTIFIED™, and the Wi-Fi logo are registered trademarks of the Wi-Fi Alliance.
- Manufactured under license from Dolby Laboratories. Dolby, Dolby Atmos, and the double-D symbol are trademarks of Dolby Laboratories.
- All other trademarks and copyrights are the property of their respective owners.

ISED Notice

This Class B digital apparatus complies with Canadian ICES-003.

This device complies with Innovation, Science and Economic Development Canada licence-exempt RSS standard(s). Operation is subject to the following two conditions:

- (1) this device may not cause interference, and
- (2) this device must accept any interference, including interference that may cause undesired operation of the device.