



Getting started guide

Turbo Hub



NETGEAR® MBR1210

Welcome and thanks for choosing Bell. Your new Turbo Hub will enable you to connect to the Internet. This guide will provide you with an overview of your Turbo Hub and steps for getting started.

A Turbo Hub User Guide CD is included in the box for additional installation information.

SETUP

Choosing a location.....	2
Inserting your Bell SIM card.....	3
Connecting the power cord.....	4
Start-up.....	5

USING YOUR TURBO HUB

Connecting a computer through Ethernet.....	6
Connecting a device through Wi-Fi.....	6

TROUBLESHOOTING

Button and LED indicator legend.....	7
FAQs.....	10
Technical Support.....	11

SETUP

Before using your Turbo Hub, please ensure you have the following:

- A Bell Turbo Hub Flex Plan
- Your Mobile Directory Number (MDN) or phone number

If you don't have an account or a Turbo Hub Flex Plan or number, get set up by speaking with a Bell account representative at [1-888-4MOBILE](tel:1-888-4MOBILE) (1-888-466-2453).

Choosing a location for your Turbo Hub

Always select an indoor location, preferably close to a window but avoiding direct sunlight. A window location generally will give the best conditions for accessing the Internet.

For best results, place the Turbo Hub away from microwave ovens and other transmitters (e.g. security/alarm systems) as they can cause signal interference.

Using the stand provided, you can position your Turbo Hub upright by inserting the tabs of the stand into the slot on the bottom of the Hub.

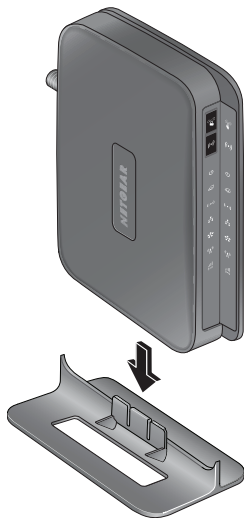

Inserting your Bell SIM card

Before turning the device on, follow the steps below:

1. Locate the SIM card slot on the back of the device.
2. Gently insert your Bell SIM card into the SIM card slot.
3. Ensure that the SIM card is inserted into the Turbo Hub with its bevelled edge facing up, as illustrated. You should hear a “click” sound when the SIM card has been inserted properly.

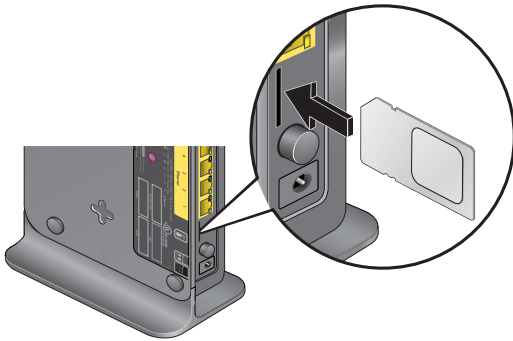



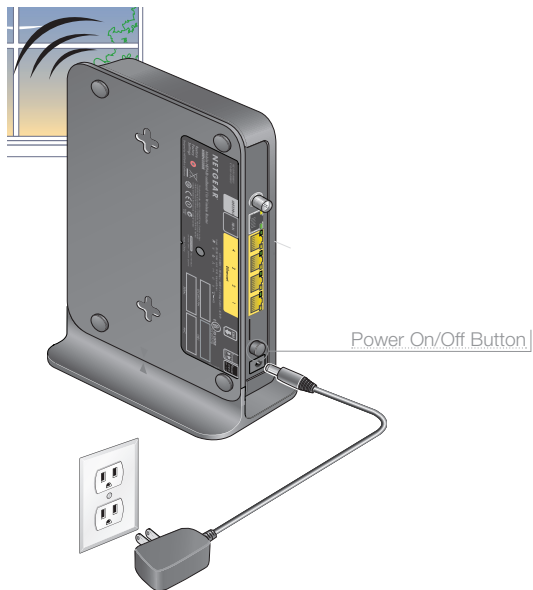

Note: You must use the SIM card you received with the Turbo Hub. SIM cards from other devices will not function in the Turbo Hub. Similarly, the SIM card provided with the Turbo Hub will not function in other devices.

Connecting the power cord

- Connect the cable from the enclosed power adapter to the power adapter input on the back of the Turbo Hub and insert the plug into an outlet.
- Power on the device (press the round button on back of device).



Start-up

- Allow approximately one minute for the Turbo Hub to boot/start-up. When the start-up procedure is finished, the following should occur:
 1. The Power button  will show amber for a moment and then turn to a steady green. A solid amber light indicates the unit has failed to power-on.
 2. When a high-speed connection is established to the Bell HSPA+ network, the 2G/3G indicator  will be lit up in solid blue.
 3. The Wi-Fi indicator  will show solid blue.
 4. The Internet Port indicator  will show green.
 5. The Signal Quality indicator  shows the quality of the signal from the Bell HSP+ network.
 - a. Solid blue: Excellent coverage
 - b. Solid green: Good coverage
 - c. Solid amber: Minimal coverage
 - d. Off: No coverage

If any of these conditions does not occur, refer to the Troubleshooting section starting on page 7.

USING YOUR TURBO HUB

Connecting your computer through an Ethernet cable

- Attach the enclosed Ethernet cable to one of the Ethernet connectors (1 – 4) on the back of the Turbo Hub.
- Connect the other end of the Ethernet connector to a PC/laptop.
- Launch your Internet browser and you're online.

You can connect up to four (4) computers using the Ethernet ports. One shielded Ethernet cable is included.

Note: If connecting additional PCs, use only shielded Ethernet cables in order to fulfill electrical emissions requirements (CE, FCC).

Connecting your device through Wi-Fi

Wi-Fi security has been enabled on your Turbo Hub. To connect through Wi-Fi, enter the following on your Wi-Fi-enabled PC/laptop or device:





- The Wi-Fi Network Name (SSID). You can find your Wi-Fi Network Name (SSID) printed on the back of your Turbo Hub. The Wi-Fi Network Name (SSID) will be BellXXXX, where XXXX is random numbers or letters.
- The WPA Passphrase. You can find your WPA Passphrase printed on the back of the Turbo Hub, under the title "WPA/WPA2 – PSK Passphrase."
- Launch your Internet browser and you're online.





Note: You can connect up to 15 devices using Ethernet and/or Wi-Fi.

TROUBLESHOOTING

Button and LED indicator legend

Below is a list of LED indicators & buttons which outline the status of your Turbo Hub:

LED Symbol	Status	Description
WPS 		Press this button to open a 2-minute window for the Turbo Hub to connect with other WPS-enabled devices. For more information about this function, see the Using Push 'N' Connect (WPS) To Configure Your Wireless Network section of the User Guide CD.
Wi-Fi 		This button is used to turn the Wi-Fi radio on and off.
Power 	Solid green	The router is powered on and operating normally.
	Solid amber	POST (Power-On Self-Test) in progress.
	Off	Power is not supplied to the router.
Internet Port 	Solid green	There is an Internet connection.
	Blinking green	Data is being transmitted over the Internet connection.
	Off	No Internet connection detected.

LED Symbol	Status	Description
Wi-Fi 	Solid blue	The Wi-Fi local port is initialized.
	Blinking blue	Data is being transmitted or received over the Wi-Fi link.
	Off	The wireless access point is turned off.
LAN Ports 	Solid green	The local Ethernet ports have detected wired links with PCs.
	Blinking	Data is being transmitted or received.
	Off	No link is detected on these ports.
WAN Port 	Solid green	The Ethernet WAN port has detected an active link.
	Blinking	Data is being transmitted or received.
	Off	No link is detected on these ports.
2G/3G 	Solid blue	Indicates the Turbo Hub is in 3G+ coverage.
	Blinking	Indicates the Turbo Hub is in 2G coverage.
	Off	No coverage is detected.

TROUBLESHOOTING (cont'd...)

Button and LED indicator legend

LED Symbol	Status	Description
Signal Quality 	Solid blue	Excellent coverage detected.
	Solid green	Good coverage detected.
	Solid amber	Minimal coverage detected.
	Off	No coverage detected.

TROUBLESHOOTING (cont'd...)

FAQs

Q: What should I do if my Turbo Hub will not turn on?

Make sure that the Turbo Hub power button has been turned on, and that the power cord is correctly connected to your Turbo Hub and a functioning power outlet. If the error persists, you may have a hardware problem and should call Bell Technical support at 1-800-667-0123.

Q: Why does the Internet Port light not come on, even though I inserted the SIM card and powered-on the Turbo Hub?

Make sure that the SIM card you receive with your Turbo Hub was inserted correctly. (Refer to page 3).

Note: You must use the SIM card you received with the Turbo Hub. SIM cards from other devices will not function in the Turbo Hub, and the Turbo Hub SIM card will not function in other devices.

Q: Why is the Wi-Fi indicator light off when I connect my device through Wi-Fi?

The Wi-Fi radio has been turned off. If you want a Wi-Fi connection with the Turbo Hub, push the Wi-Fi button  to turn the Wi-Fi radio back on.

Q: What should I do if the Signal Quality indicator light is off or amber?

If the Signal Quality light is off, unplug the power cable to the Turbo Hub. Remove the SIM card and then reinsert the SIM card (ensure it is inserted correctly). Plug the power cable back in and wait for the Turbo Hub to restart. If the 2G/3G and/or Internet indicator light is still not on, you may need to call Bell Technical support at 1-800-667-0123.

If the Signal Quality light is amber, this means that you may not be receiving a very strong signal. An external antenna may be required in areas with low signal strength. For more details or to speak to Bell Technical support call 1-800-667-0123.

Q: Is the Turbo Hub Wi-Fi turned on automatically?

Yes, the Turbo Hub has the Wi-Fi functionality turned on by default. You'll need to configure your device(s) to connect to the Turbo Hub Wi-Fi. (Refer to page 6).

Q: Does the Turbo Hub offer a secure Wi-Fi setup?

Yes, the Turbo Hub Wi-Fi connection has been secured using the WPA protocol. Your Wi-Fi Network Name (SSID) and WPA Passphrase have been printed on the back of your Turbo Hub.

TROUBLESHOOTING (cont'd...)

Technical Support

For support with connectivity to your Turbo Hub, or for billing inquiries, contact Bell Mobility at 1 800 667-0123.

For product support contact NETGEAR at 1 877 838-9126, or visit kbserver.netgear.com.

Note: After activating your Turbo Hub, locate the serial number on the label of your product and use it to register your product at www.netgear.com/register. Registration is required before you can use the NETGEAR telephone support service. Go to kbserver.netgear.com for product updates and Web support.

© 2010 NETGEAR, Inc., NETGEAR, the NETGEAR Logo, and Connect with Innovation are trademarks of NETGEAR, Inc. in the United States and/or other countries. Other brand names mentioned herein are for identification purposes only and may be trademarks of their respective holder(s). Information is subject to change without notice. All rights reserved.

Wi-Fi is a trademark of the Wi-Fi Alliance. Bell Canada product or service names or logos referenced in this document are trade-marks or registered trade-marks of Bell Canada or its related companies.



201-12941-01