

Your HTC Legend

User guide

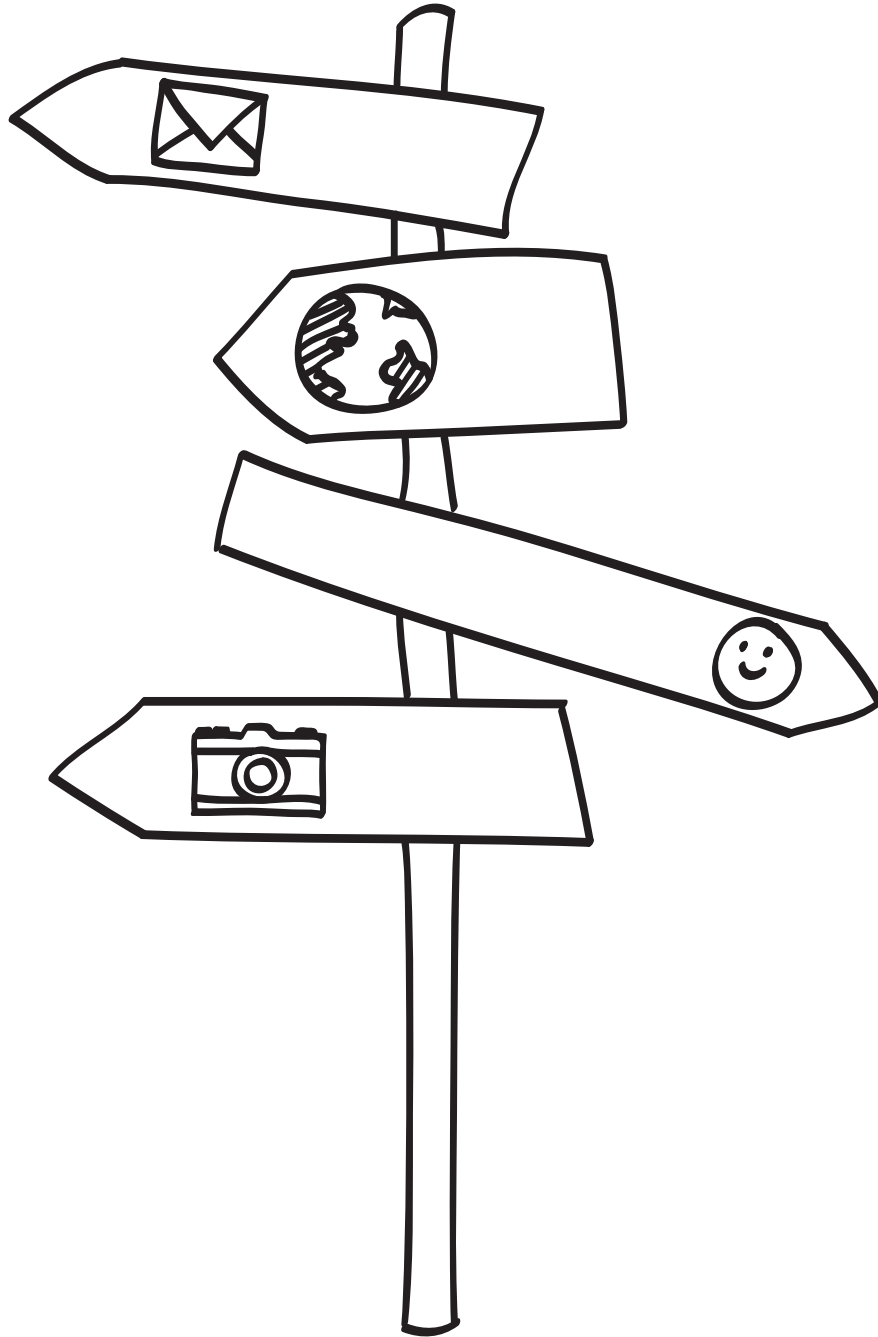

htc
quietly brilliant

Before you do anything else, please read this

Charge the battery

The battery in your phone hasn't been charged yet. While your phone is charging, it's important that you do not remove the battery pack. Doing so can damage your phone. Also, please don't try to take your phone apart. (If you do, it may invalidate your warranty.)

Choose a rate plan wisely

Your phone can use up a lot of Internet bandwidth really quickly. Before you use your phone, we strongly recommend that you talk to your mobile operator to find a data plan that best meets your needs.

Know about privacy laws

Some countries have strict laws about how and when you can record phone conversations. For example, you may need to tell the person you're speaking to before you start recording. It's a good idea to find out what the laws are where you live before you use your phone's recording feature.

HTC Hotline Support

English 1866-449-8358

7 days a week

6am EST to 1am EST

And finally, a few important words from our legal team (LIMITATION OF DAMAGES)

To the maximum extent permitted by applicable law, in no event shall HTC or its affiliates be liable to you, any user, or third party for any indirect, special, consequential, incidental or punitive damages of any kind, arising in contract, tort, or otherwise, including, but not limited to, injury, loss of revenue, loss of goodwill, loss of business opportunity, loss of data, and/or loss of profits, regardless of the foreseeability thereof or whether HTC or its affiliates have been advised of the possibility of such damages. And in no event shall the total liability of HTC or its affiliates exceed the amount received from you, regardless of the legal theory under which the cause of action is brought. The foregoing does not affect any statutory rights which may not be disclaimed.

Please also read the Safety and regulatory guide that is included in the box for information on the proper usage of your phone to prevent injuries and to avoid damaging your phone. You can also refer to this guide for regulatory information about your phone.

You can also visit our support website at www.htc.com/ca/support to download the Safety and regulatory guide and to access other helpful resources for your phone.

Trademarks and copyrights

Copyright © 2010 HTC Corporation. All Rights Reserved.

The HTC logo, the HTC quietly brilliant logo, HTC Legend, HTC Sense, Footprints, HTC Sync, and HTC Care are trademarks and/or service marks of HTC Corporation.

Copyright © 2010 Google Inc. Used with permission.

Google, the Google logo, Android, Google Search, Google Maps, Gmail, YouTube, Android Market, and Google Talk are trademarks of Google Inc.

Google, the Google logo and Google Maps are trademarks of Google, Inc. TeleAtlas® Map Data ©2010. Street View Images ©2010 Google.

Microsoft, Windows, Windows XP, Windows Vista, Active Sync, and Outlook are either registered trademarks or trademarks of Microsoft Corporation in the United States and/or other countries.

Bluetooth and the Bluetooth logo are trademarks owned by Bluetooth SIG, Inc.

Wi-Fi is a registered trademark of the Wireless Fidelity Alliance, Inc.

microSD is a trademark of SD Card Association.

Java, J2ME and all other Java-based marks are trademarks or registered trademarks of Sun Microsystems, Inc. in the United States and other countries.

Facebook is a trademark of Facebook, Inc.

Twitter is a trademark of Twitter, Inc., and is used under license.

Flickr is a trademark of Yahoo! Inc.

Licensed by QUALCOMM Incorporated under one or more of the following patents:

4,901,307 5,490,165 5,056,109 5,504,773 5,101,501 5,778,338 5,506,865 5,109,390 5,511,073
5,228,054 5,535,239 5,710,784 5,267,261 5,544,196 5,267,262 5,568,483 5,337,338 5,659,569
5,600,754 5,414,796 5,657,420 5,416,797

All other company, product and service names mentioned herein are trademarks, registered trademarks or service marks of their respective owners.

HTC shall not be liable for technical or editorial errors or omissions contained herein, nor for incidental or consequential damages resulting from furnishing this material. The information is provided "as is" without warranty of any kind and is subject to change without notice.

HTC also reserves the right to revise the content of this document at any time without prior notice.

No part of this document may be reproduced or transmitted in any form or by any means, electronic or mechanical, including photocopying, recording or storing in a retrieval system, or translated into any language in any form without prior written permission of HTC.

Conventions used in this guide

In this user guide, we use the following symbols to indicate useful and important information:



This is a note. A note often gives additional information, such as what happens on your phone when you choose to do or not to do a certain action. A note also provides information that may only be applicable to some situations.



This is a tip. A tip gives you an alternative way to do a particular step or procedure, or lets you know of an option that you may find helpful.



This indicates that something is very important. Important information is something that you need to do in order to accomplish a certain task or to get a phone feature to work properly.



This provides safety precaution information, that is, information that you need to be careful about to prevent potential problems when using your phone.

Contents

Basics	14
Inside the box	14
Your Phone.....	14
Front panel	14
Back panel	15
Top panel	16
Left panel.....	16
Bottom panel.....	17
Before turning on your phone	18
Bottom cover.....	18
Battery compartment door	19
SIM card	19
Storage card	20
Battery	21
Finger gestures.....	23
Getting started	24
Turning on your phone	24
Turning off your phone.....	24
Setting up your phone for the first time	24
Sleep mode.....	26
Home screen	27
Extended Home screen	27
Navigating the Home screen	27
Phone status and notifications.....	28
Phone status icons.....	28
Notification icons.....	29
Checking notifications	31
Adjusting the volume.....	32
Adjusting the ringer volume	32
Adjusting the media volume.....	32
Connecting your phone to a computer	33
Copying files to and from the storage card	34
Searching your phone and the Web	35
Setting Web and Quick Search Box options	35
Searching the Web and your phone using the Quick Search Box.....	35
Personalizing	36
Making your phone truly yours	36
Changing the ringtone	36
Personalizing your phone with scenes.....	37
Using a preset scene.....	37
Customizing and saving a scene	37
Renaming or deleting a scene	37
Changing your wallpaper	38
Changing your Home screen or lock screen wallpaper.....	38

Personalizing your Home screen with widgets.....	39
Adding a widget to your Home screen	39
Downloading HTC widgets.....	39
Adding application icons and other shortcuts on your Home screen	40
Adding folders on your Home screen	41
Creating a new folder and adding items to it.....	41
Renaming a folder.....	41
Rearranging or removing widgets and icons on your Home screen.....	42
Moving a widget or icon	42
Removing a widget or icon	42
Phone calls	43
Making calls	43
Calling somebody using your phone	43
Calling a speed dial number.....	44
Calling a phone number in a text message	44
Calling a phone number in an email.....	44
Making an emergency call	45
Receiving calls	46
Answering an incoming call	46
Rejecting an incoming call.....	47
Rejecting a call and sending a text message.....	47
Using in-call options	48
Handling multiple calls.....	48
Setting up a conference call	49
Putting a call on hold.....	49
Muting the microphone during a call.....	49
Turning the speakerphone on or off during a call.....	49
Ending a call	49
Using call history	50
Adding a new phone number to your contacts from call history	50
Checking a missed call.....	51
Clearing the call history list	51
Call services	52
Turning Airplane mode on or off	53
People	54
About People	54
Ways of getting contacts into your phone.....	54
People screen	55
Setting up My contact card.....	55
Your contacts list.....	55
Adding a new contact.....	56
Importing contacts from your SIM card.....	57
Importing contacts from online directories.....	57
Merging contact information.....	57
Editing a contact's information	58
Searching for a contact.....	58
Backing up your contacts to the storage card.....	58
Importing contacts from the storage card	58
Deleting contacts	59
Sending contact information as a vCard via MMS	59

Sending your contact information as a vCard via MMS.....	59
Contact groups	60
Creating a group and adding contacts.....	60
Deleting a group.....	60
Adding or removing contacts from a group.....	60
Sending an SMS/MMS message or email to a group.....	61
Contact information and conversations	62
People widget.....	63
Adding the People widget.....	63
Setting the default communication method.....	63
Changing the default communication method.....	63
Getting in touch with a contact	63
Keyboard	64
Using the onscreen keyboard.....	64
Using the landscape onscreen keyboard.....	64
Changing the onscreen keyboard layout.....	64
Entering text.....	65
Entering words with predictive text.....	65
Adjusting touch input settings.....	67
Touch Input settings	67
Text input.....	67
Messages	69
About Messages	69
Sending text and multimedia messages.....	69
New message notifications.....	72
WAP push messages.....	73
Managing message conversations.....	74
Protecting a message from deletion.....	75
Deleting a message thread.....	75
Deleting several message threads	75
Deleting a single message	75
Viewing contact details and communicating with a contact	75
Setting text and multimedia message options	76
Adding the Messages widget	77
Accounts and sync	78
Synchronizing with online accounts	78
Adding a social network account.....	78
Synchronizing with a Google Account	78
Synchronizing with a Microsoft Exchange ActiveSync account.....	79
Managing your accounts	79
Using HTC Sync.....	81
Installing HTC Sync from www.htc.com/ca/support	81
Setting up HTC Sync to recognize your phone.....	81
Setting up synchronization.....	82
Setting up more sync options.....	83
Synchronizing your phone.....	84
Downloading the latest HTC Sync upgrade.....	84
Installing apps from your computer to your phone	84

Social	86
Facebook for HTC Sense	86
Using the Facebook application.....	86
Adding the Facebook widget.....	87
Twittering on your phone.....	88
Peep screen.....	88
Sending a tweet	88
Searching for Twitter users to follow.....	89
Sending a direct message.....	89
Setting Peep options.....	89
Adding the Twitter widget.....	90
Using Friend Stream.....	91
Friend Stream screen	91
Updating your status.....	92
Adding the Friend Stream widget	92
Chatting in Google Talk.....	93
Signing in to Google Talk.....	93
Chatting with friends	93
Changing your online status and picture.....	94
Managing your Friends list.....	95
Changing Google Talk settings.....	96
Email	98
Using Gmail/Google Mail	98
Viewing your Gmail/Google Mail inbox	98
Reading your messages	99
Sending a message.....	101
Managing conversations and messages.....	102
Changing Gmail/Google Mail settings	103
Mail.....	105
Adding a POP3/IMAP email account	105
Viewing your email inbox	105
Exchange ActiveSync email.....	107
Composing and sending an email message.....	108
Viewing and replying to an email message.....	109
Editing email account settings	109
Deleting an email account	109
Adding the Mail widget.....	109
Calendar	110
About Calendar	110
Creating a calendar event.....	110
Inviting guests to your event (Google Account only).....	111
Sending a meeting request using Calendar (Exchange ActiveSync only).....	111
Changing calendar views	112
Month view	112
Day and Agenda views.....	112
Week view.....	113
Viewing, editing or deleting an event.....	114
Viewing and editing an event.....	114
Deleting an event.....	114

Calendar event reminders	115
Viewing, dismissing, or snoozing event reminders	115
Displaying and synchronizing calendars	116
Showing or hiding calendars	116
Choosing which Google Calendars are synchronized on your phone	116
Changing Calendar settings	117
Reminder settings	117
Calendar view settings	117
Sending a vCalendar	118
About the Calendar widget	118
Clock and Weather	119
About the HTC Clock widget	119
About the Clock application	120
Using Desk Clock	121
Using World Clock	122
Setting your home city	122
Setting the time zone, date, and time	122
Adding a city to the World Clock screen	123
Setting the alarm clock	124
Setting an alarm	124
Deleting an alarm	124
Changing alarm sound settings	125
Checking weather	126
Adding a city to the Weather screen	126
Changing the order of cities on the Weather screen	127
Deleting cities from the Weather screen	127
Changing weather options	127
About the Weather widget	127
Internet	128
Data connection	128
Checking the data connection you are using	128
Turning the data connection on or off	128
Creating a new access point	128
Enabling data roaming	128
Wi-Fi	129
Turning Wi-Fi on and connecting to a wireless network	129
Connecting to a Wi-Fi network with EAP-TLS security	129
Checking the wireless network status	130
Connecting to another Wi-Fi network	130
Adding the Data connection and Wi-Fi widgets	131
Connecting to a virtual private network (VPN)	132
Preparing your phone for VPN connection	132
Adding a VPN connection	132
Connecting to a VPN	132
Disconnecting from a VPN	133
Using your phone's web browser	134
Opening the browser	134
Going to a web page	134

Setting your home page	134
Changing the screen orientation	134
Browsing full versions of all web sites.....	135
Navigating on a web page.....	135
Zooming in or out on a web page	135
Selecting a link in a web page.....	136
Opening a new browser window	136
Switching between browser windows	137
Finding text within a web page.....	137
Downloading applications from the web.....	137
Copying text, looking up information, and sharing	138
Viewing bookmarks and previously visited pages.....	139
Setting browser options.....	140
Using your phone as a modem (tethering).....	141
Bluetooth	142
Using Bluetooth	142
Turning Bluetooth on or off.....	142
Changing the phone name	142
Connecting a Bluetooth headset or car kit	143
Reconnecting a headset or car kit.....	143
Disconnecting or unpairing from a Bluetooth device	144
Disconnecting a Bluetooth device	144
Unpairing from a Bluetooth device	144
Sending and receiving information using Bluetooth	145
Sending information from your phone to another device	145
Receiving information from another device.....	146
Camera	148
Camera basics.....	148
Viewfinder screen.....	148
Using the optical trackball as the shutter release	149
Review screen	149
Zooming.....	150
Taking a photo.....	151
Capturing a video.....	152
Camera settings	153
Changing basic settings.....	153
Changing advanced settings	153
Photos	156
About the Photos application	156
Selecting an album	156
Viewing photos and videos	157
Browsing in filmstrip or grid view.....	157
Viewing a photo in landscape orientation	157
Zooming in or out on a photo.....	158
Watching video	158
Viewing photos in your social networks.....	159
Viewing photos on Facebook.....	159

Viewing photos on Flickr	159
Working with photos	160
Rotating and saving a photo	160
Cropping a photo	160
Sharing	161
Sending photos or videos by email	161
Sending a photo or video by MMS	161
Sending photos or videos using Bluetooth	161
Sharing photos on Facebook	162
Sharing photos on Flickr	162
Sharing photos on Picasa	162
Sharing videos on YouTube	162
Music	163
About the Music application	163
Playing music	163
Browsing music in the Library	164
Creating a playlist	165
Playing the songs in a playlist	165
Managing playlists	165
Setting a song as ringtone	167
Checking if the song was added as a ringtone	167
Sending music using Bluetooth	167
About the Music widget	167
Maps and location	168
Using Google Maps	168
Viewing locations	168
Viewing map layers	170
Searching for a location	171
Getting directions	172
Finding your friends with Google Latitude (available by country)	173
Using HTC Footprints™	176
Creating a footprint	176
Revisiting a footprint	176
Editing or deleting a footprint	177
Exporting your footprints	177
Importing footprints	178
Adding the Footprints widget	178
More apps	179
Watching videos on YouTube	179
Watching videos	179
Searching for videos	179
Sharing a video link	180
Capturing a video and sharing it on YouTube	180
Viewing a PDF	181
Viewing documents, presentations, and spreadsheets	182
Keeping track of your stocks	183
Adding a stock quote or stock market index	183

Changing the stock list order	183
Deleting stock quotes and indices.....	183
Setting stock information update frequency.....	184
Manually updating stock information.....	184
Adding the Stocks widget	184
Listening to the radio.....	185
Listening to an FM station.....	185
Adding station names	186
Minimizing or turning off FM Radio.....	186
Recording your voice	187
Recording your voice.....	187
Sharing a voice clip.....	187
Setting a voice clip as a ringtone	187
Renaming a voice clip	187
Finding and installing apps from Android Market	188
Finding and installing an application.....	188
Creating a Google Checkout account.....	189
Requesting a refund for an application.....	189
Opening an installed application	190
Uninstalling an application.....	190
Getting help	190
Reading news feeds	191
News screen.....	191
Subscribing to a news channel from a list	191
Subscribing to a news channel by entering a URL	192
Setting update frequency for stories.....	192
Reading a story	192
Starring a story.....	192
Adding a keyword.....	193
Adding the News widget.....	193
Security	194
Protecting your SIM card with a PIN.....	194
Restoring a SIM card that has been locked out	194
Protecting your phone with a screen lock.....	195
Settings	196
Settings on your phone.....	196
Changing display settings.....	198
Adjusting the screen brightness manually.....	198
Adjusting the time before the screen turns off	198
Preventing automatic screen rotation.....	198
Recalibrating the G-sensor	198
Keeping the screen on while charging the phone.....	198
Switching animation effects on or off.....	199
Changing sound settings.....	200
Changing the phone language.....	201
Optimizing your phone's battery life.....	202
Using the GSM network of your mobile operator	202
Checking the power usage of applications	202
Managing memory	203
Checking how much phone memory is available for use	203

Checking the available storage card space.....	203
Clearing application cache and data.....	203
Uninstalling third-party applications.....	203
Freeing up more phone memory or storage card space.....	203
Checking information about your phone.....	204
Backup, update and reset	205
Backing up phone data.....	205
Checking if automatic backup is enabled.....	205
Restoring backed up data to your phone.....	205
Updating your phone's system software.....	206
Checking for phone system software updates manually.....	206
Performing a hard/factory reset.....	207
Specifications	208
Index	209

Basics

Inside the box

You will find the following inside the box:

- Phone
- USB cable
- AC adapter
- 3.5mm stereo headset
- Battery
- microSD card (Micro SD card is pre loaded in phone.)
- Quick start guide, Warranty card, Safety and Regulatory Guide and EULA

Your Phone

Front panel

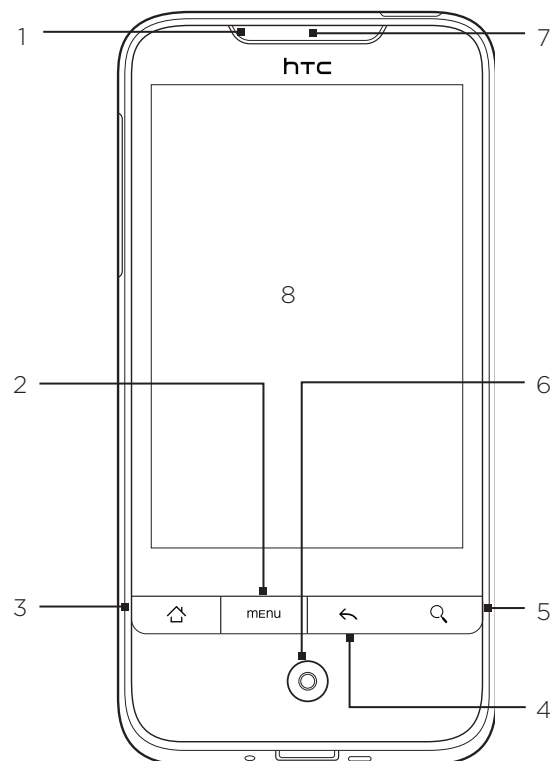

1 Notification LED

This LED shows a:

- Solid green light when the phone is connected to the power adapter or a computer and the battery is fully charged.
 - Flashing green light when you have a pending notification.
 - Solid red light when the battery is being charged.
 - Flashing red light when the battery level reaches very low.
-

2 MENU

Press to open a list of actions that you can do on the current screen.

3 HOME

- While on any application or screen, press to return to the Home screen.
- While on the main Home screen, press to show a snapshot of the Home screen.
- Press and hold to open the recently-used applications window.

4 BACK

Press to go back to the previous screen, or to close a dialog box, options menu, the Notifications panel, or onscreen keyboard.

5 SEARCH

- Press to open the Quick Search box.
- See “Searching your phone and the Web” in this chapter for more details.

6 Optical trackball

Swipe your finger over or press to highlight or select items onscreen.

7 Earpiece

Listen to a phone call from here.

8 Touch screen

Back panel

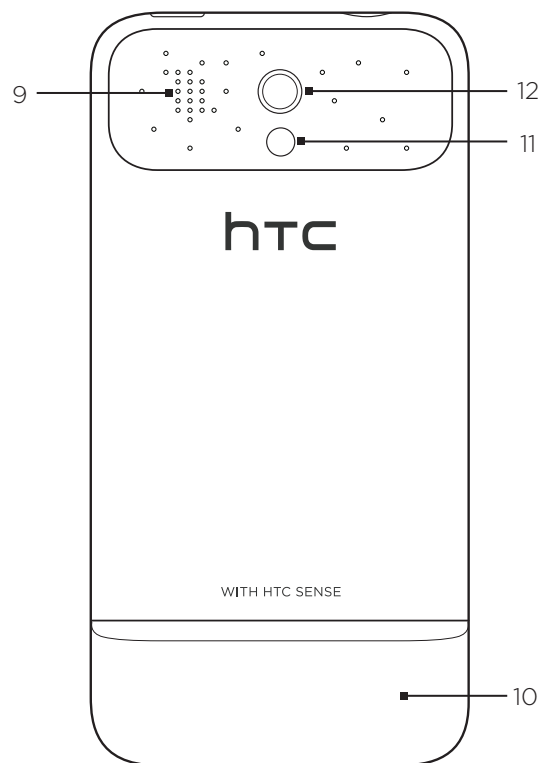

9 Speaker

10 Bottom cover

11 LED flashlight

12 5 megapixel camera



The two prongs underneath the bottom cover act as the antenna for your phone. It is recommended that you secure the bottom cover to the phone to ensure that you get the best radio reception for your phone.

Top panel

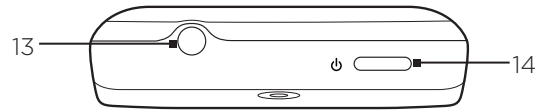

13 3.5mm audio jack

Connect a 3.5mm stereo headset for hands-free conversation or for listening to music.

14 POWER

- When the phone is off, press to turn on the phone.
 - When the phone is on and the screen is unlocked, press to turn off or on the phone display.
 - With the screen unlocked, press and hold to open the phone options menu that lets you turn off the phone, switch your phone to silent mode, vibration mode, or airplane mode, and turn on/off the data connection.
-

Left panel

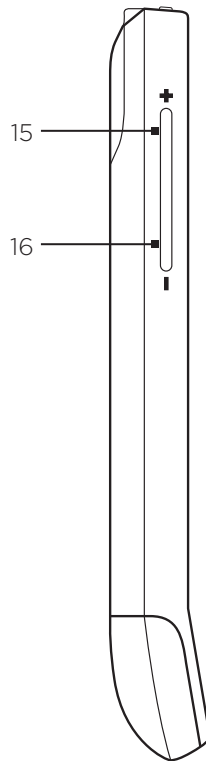

15 VOLUME UP

- While on a call, press to increase earpiece volume.
 - While not on a call, press to increase the ringer volume.
 - While watching videos or listening to the FM radio, press to increase the volume.
-

16 VOLUME DOWN

- While on a call, press to decrease earpiece volume.
 - While not on a call, press to decrease the ringer volume.
 - While watching videos or listening to the FM radio, press to decrease the volume.
-

Bottom panel

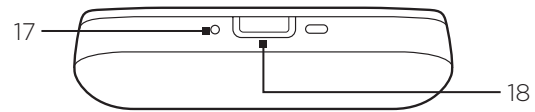

17 Microphone

18 USB connector

- Connect the power adapter to charge the battery.
 - Connect the supplied USB cable to transfer files to your phone from your computer or sync your phone with HTC Sync on your computer.
-

Before turning on your phone

Bottom cover

Removing the bottom cover

Remove the bottom cover to access the battery compartment, SIM card slot, and storage card slot.

1. Hold your phone securely with the front facing down.
2. With your right and left thumbs, push the bottom cover out to remove it.

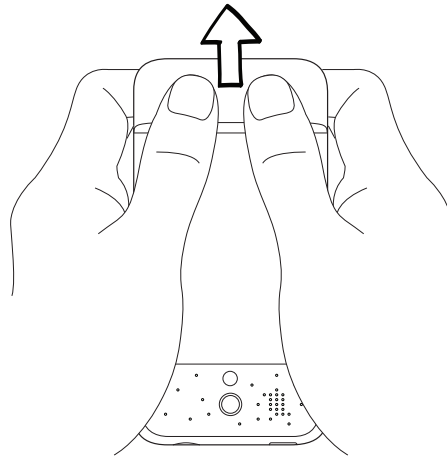

Replacing the bottom cover

1. Align the two openings underneath the bottom cover with the two notches on the bottom of the phone.

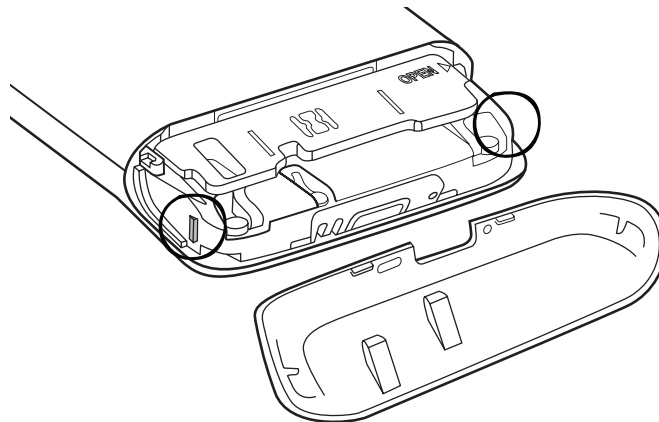

2. Place the bottom cover on the phone and then push the bottom cover (from the center) until it clicks into place to secure it.



The two prongs underneath the bottom cover act as the antenna for your phone. It is recommended that you secure the bottom cover to the phone to ensure that you get the best radio reception for your phone.

Battery compartment door

Opening the battery compartment door

1. Hold your phone securely with the front facing down.
2. Open the battery compartment door by flipping it open from the right side.

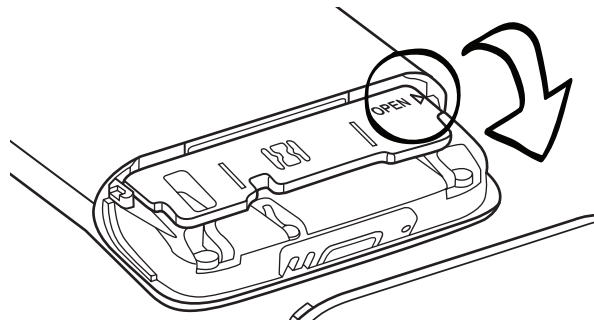

Closing the battery compartment door

1. Hold your phone securely with the front facing down.
2. Flip the battery compartment door back into place to close it.

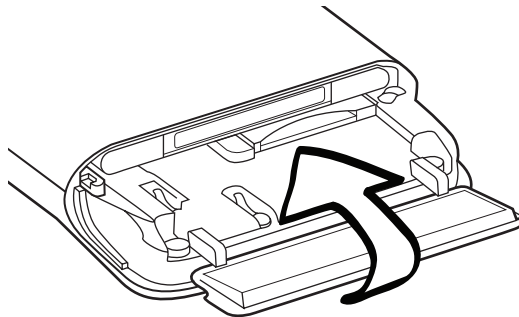

3. Gently push down the battery compartment door until it clicks into place to lock it.

SIM card

The SIM card contains your phone number, service details, and phonebook/message memory. Your phone supports both 1.8V and 3 V SIM cards.



Some legacy SIM cards may not function with your phone. You should consult with your mobile operator for a replacement SIM card. There may be fees for this service.

Inserting the SIM card

The SIM card slot is located below the battery compartment.

1. Remove the bottom cover. Refer to “Removing the bottom cover.”
2. Open the battery compartment door. Refer to “Opening the battery compartment door.”
3. Insert the SIM card with its gold contacts facing down and its cut-off corner facing out.

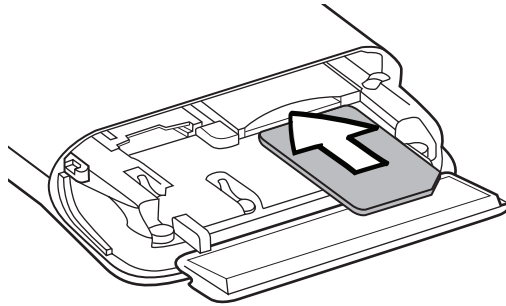

4. Push the SIM card in until it clicks into place.

Removing the SIM card

1. Remove the bottom cover. Refer to “Removing the bottom cover.”
2. Open the battery compartment door. Refer to “Opening the battery compartment door.”
3. Push the SIM card in to eject it from its slot.

Storage card

Store your pictures, music, and applications by inserting the supplied microSD card into your phone.

Inserting the storage card

The storage card slot is located below the battery compartment.

1. Remove the bottom cover. Refer to “Removing the bottom cover.”
2. Open the battery compartment door. Refer to “Opening the battery compartment door.”
3. Insert the microSD card into the slot with its gold contacts facing down and push it in until it clicks into place.

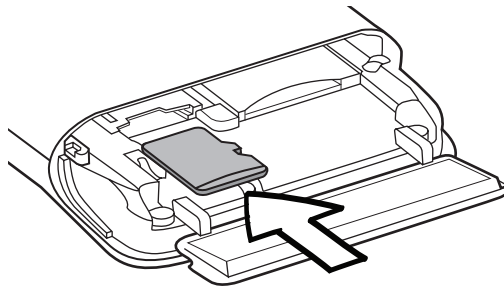

If the battery is installed, remove the battery first to make it easier to insert the storage card. See “Removing the battery” in this chapter for details.

Removing the storage card

1. Remove the bottom cover. Refer to “Removing the bottom cover.”
2. Open the battery compartment door. Refer to “Opening the battery compartment door.”
3. Push the storage card in to eject it from its slot.



If the battery is installed, remove the battery first to make it easier to remove the storage card. See “Removing the battery” in this chapter for details.

Removing the storage card while the phone is on

When you need to remove the storage card while the phone is on, unmount the storage card first to prevent corrupting or damaging the files in the storage card.

1. Press HOME > MENU, and then tap **Settings**.
2. Scroll down the screen, and then tap **SD card & phone storage**.
3. Tap **Unmount SD card**.
4. Remove the storage card by following the instructions in “Removing the storage card.”

Battery

Your phone comes with a rechargeable Lithium-ion polymer or Lithium-ion battery and is designed to use only manufacturer-specified original batteries and accessories. Battery performance depends on many factors, including network configuration, signal strength, the temperature of the environment in which you operate your phone, the features and/or settings you select and use, items attached to connecting ports, and your voice, data, and other program usage patterns.

Inserting the battery

1. Remove the bottom cover. Refer to “Removing the bottom cover.”
2. Open the battery compartment door. Refer to “Opening the battery compartment door.”
3. Insert the battery with its exposed copper contacts into the phone first. The exposed copper contacts should be on the right when you insert the battery.

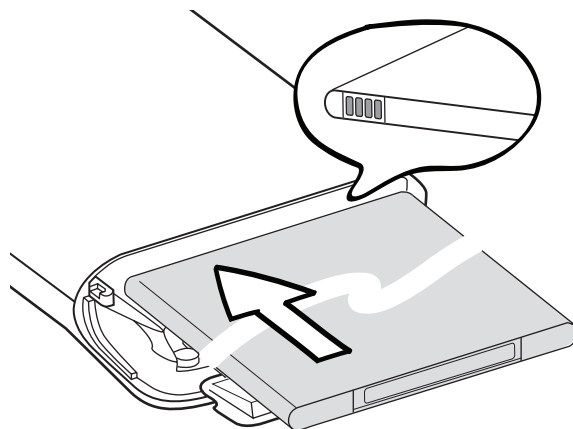

4. Push the battery all the way in.

Removing the battery

1. Remove the bottom cover. Refer to “Removing the bottom cover.”
2. Open the battery compartment door. Refer to “Opening the battery compartment door.”
3. Pull out the red battery release to expose the battery, and then pull the battery out.

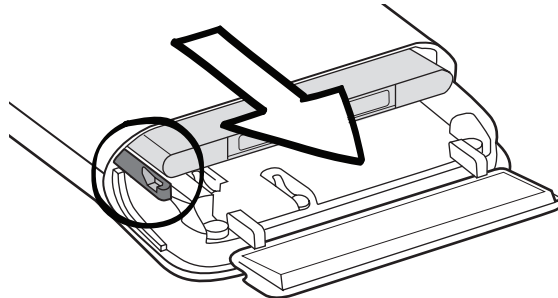

Charging the battery

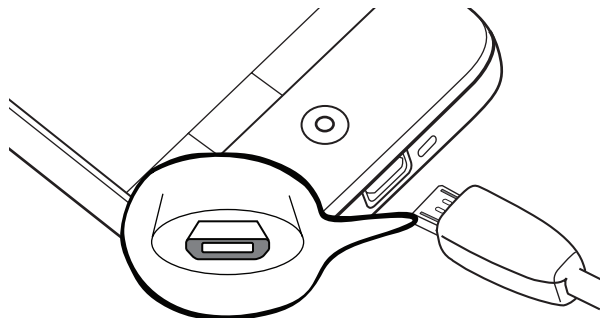

The battery is partially charged when shipped. Before you turn on and start using your phone, it is recommended that you charge the battery. Some batteries perform best after several full charge/discharge cycles.

1. Attach the power plug to the AC adapter.
2. Connect one end of the USB cable to the sync connector on your phone.



3. Connect the other end of the USB cable to the USB port of the AC adapter.
4. Plug in the AC adapter to an electrical outlet to start charging the battery.

As the battery is being charged, the notification LED (located on the right side of the earpiece) shows a solid red light when the battery is being charged. The light turns to solid green when the phone is fully charged.

When you charge the battery while the phone is on, the charging battery icon () is displayed in the status bar of the Home screen. After the battery has been fully charged, a full battery icon () will be displayed in the status bar of the Home screen.



- Only the AC adapter and USB sync cable provided with your phone must be used to charge the battery.
- Do not remove the battery from the phone while you are charging it using the AC or car adapter.
- As a safety precaution, the battery stops charging when it overheats.

Finger gestures

Tap

When you want to type using the keyboard, select items onscreen such as application and settings icons, or press onscreen buttons, simply tap them with your finger.

Press and hold

To open the available options for an item (e.g. contact or link in a web page), simply press and hold the item.

Swipe or slide

To swipe or slide means to quickly drag your finger vertically or horizontally across the screen or optical trackball.

Drag

Press and hold your finger with some pressure before you start to drag. While dragging, do not release your finger until you have reached the target position.

Flick

Flicking the screen is similar to swiping, except that you need to swipe your finger in light, quicker strokes. This finger gesture is always in a vertical direction, such as when flicking the contacts or message list.

Rotate

For most screens, you can automatically change the screen orientation from portrait to landscape by turning the phone sideways. When entering text, you can turn the phone sideways to bring up a bigger keyboard. Refer to the Settings chapter for more details.

Pinch

For some applications, like Photos or the web browser, you can “pinch” the screen using 2 fingers (for example, thumb and index fingers) to zoom in or zoom out when viewing a picture or a web page.

Getting started

Once you've installed your SIM card, battery, and microSD card, you can turn on your phone and start using it.

Turning on your phone

Press the POWER button.



When you turn on the phone for the first time, you will be prompted to set up your phone. For more information on how to set up your phone for the first time, see “Setting up your phone for the first time.”

Entering your PIN

If your SIM card is preset with a PIN (personal identification number), you will be prompted to enter the PIN to proceed. Enter the SIM PIN, then tap OK.

To learn how to enable or disable the SIM PIN, see “Protecting Your Phone” in the Security chapter.



Most SIM cards are preset with a PIN (personal identification number) that is provided by your mobile operator. When prompted, enter the preset PIN, then tap **Enter**. If you enter the wrong PIN three times, the SIM card is blocked. If this happens, you can unblock it with the PUK (PIN Unblocking Key) obtained from your mobile operator.

Turning off your phone

If you do not need to use your phone, you can turn the power off to save battery life.

1. If the display is off, press the POWER button to turn the display back on.
2. Unlock your phone if the Lock screen is displayed. See “Unlocking the screen” in this chapter for details.
3. Press and hold the POWER button for a few seconds.
4. When the Phone options menu appears, tap **Power off**.
5. Tap **OK** when prompted to turn off the phone.

Setting up your phone for the first time

When you turn on your phone for the first time, your phone displays tutorials and guides you to set up your email accounts and favorite social networks such as Facebook®, YouTube™, and Twitter™. You can follow the onscreen instructions to complete the setup, or skip the setup and do it at another time.

1. Some data and settings are automatically backed up to the storage card. Clear the check box if you do not want to automatically back up data and settings to the storage card, and then tap **OK**. See the Backup, update, and reset chapter to learn what items are backed up to the storage card.
2. Choose the phone language you want to use, and then tap **Next**.
3. Your phone first sets up GPRS/3G, MMS, and WAP connections automatically based on your SIM card.



If you did not insert your SIM card and you turned on your phone for the first time, your phone displays a tutorial showing how to install the SIM card and battery. Turn off your phone and insert your SIM card before proceeding to use the phone.

4. Your phone walks you through a tutorial on how to use the onscreen keyboard. Follow through the tutorial to learn how to use the onscreen keyboard. Tap **Skip** to not go through the tutorial.
5. On the Internet connection screen, select how you want to connect to the Internet, and then tap **Next**.
6. If there are Wi-Fi networks in range, you will be asked if you want to connect to a Wi-Fi network. Tap **Next** and then tap the wireless network that you want, or clear the **Connect to Wi-Fi network** checkbox, and then tap **Next** to set up your Wi-Fi connection at a later time.
7. Some phone features such as Weather and Footprints require Google's location service to automatically determine your current location. On the Location consent screen, you can choose whether to allow Google's location service to collect information about your location. Clear or select the checkbox, and then tap **Next**.



This service may incur additional data transfer fees from your provider. You can enable or disable this service later in your phone's location settings.

8. On the Set up accounts screen, choose the type of account you want to set up and follow the onscreen instructions to complete the setup. Tap **Skip** to set up accounts at a later time.
 - To set up your Google Account, tap **Google account > Next > Sign in**, enter your Google Account details, and then tap **Sign in**.
 - To learn how to set up POP3 and Microsoft Exchange ActiveSync accounts, see the Sync and Email chapters to learn how to set up these accounts.

After setting up an account, you will be taken back to the Set up accounts screen so you can set up more accounts. When you are done setting up your accounts, tap **Next**.

9. On the Set up social networks screen, choose the type of social network account such as Facebook (for HTC Sense) and Twitter that you want to access from your phone. Follow the onscreen instructions to log in to your social network account. Tap **Skip** to set up social network accounts at a later time.

When you are done setting up your accounts, tap **Next** on the Set up social networks screen.

10. The final screen shows you where you can learn more about using your phone. Tap **Finish**.

Sleep mode

Sleep mode suspends your phone to a low power state while the display is off in order to save battery power. You will still be able to receive messages and calls while the phone is in Sleep mode.



For information on how to adjust the time before the screen turns off, see “Adjusting the time before the screen turns off” in the Settings chapter.

Switching to Sleep mode

Briefly press the POWER button to turn off the display temporarily and switch your phone to Sleep mode. Your phone also automatically goes into Sleep mode when you leave the phone idle after a certain period of time. Switching to Sleep mode also prevents accidental button or touch screen presses when the phone is in your bag or pocket.

Waking up from Sleep mode

Your phone wakes up automatically when you have an incoming call. To wake up your phone manually, press the POWER button. You will then see that the phone has locked the screen. To find out how to unlock the screen, see “Unlocking the screen.”

Unlocking the screen

Press the bar on the lock screen and then slide your finger down to unlock the screen or to answer an incoming call.

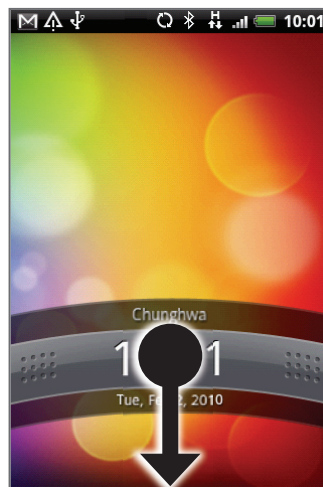

You can also press MENU while on the lock screen to unlock the screen.



If you have set up a screen unlock pattern, you will be prompted to draw the pattern on the screen before it unlocks. For more information on how to create and enable the screen unlock pattern, see “Protecting your phone with a screen lock” in the Security chapter.

Home screen

The Home screen provides you with a weather clock that shows the time and weather of your current location. Tap the respective item to open the associated application.

The Home screen also lets you add the items you want and need on the Home screen. Add items like application icons, shortcuts, folders, and widgets to give you instant access to information and applications. To learn how to personalize your Home screen, see the Personalizing chapter.

Extended Home screen

The Home screen extends beyond the screen width to provide more space for adding icons, widgets, and more. There are 6 “additional” screens apart from the main Home screen.



You cannot add more screens.

Navigating the Home screen

You can go to the extended Home screen by sliding your finger horizontally across the screen to go to the left or right side of the Home screen. While on an extended Home screen, press HOME to return to the main Home screen.

Directly going to a particular screen

1. On any Home screen, pinch the screen to bring up a snapshot of the Home screen.



On the main Home screen, you can press HOME to show the snapshot of the Home screen.









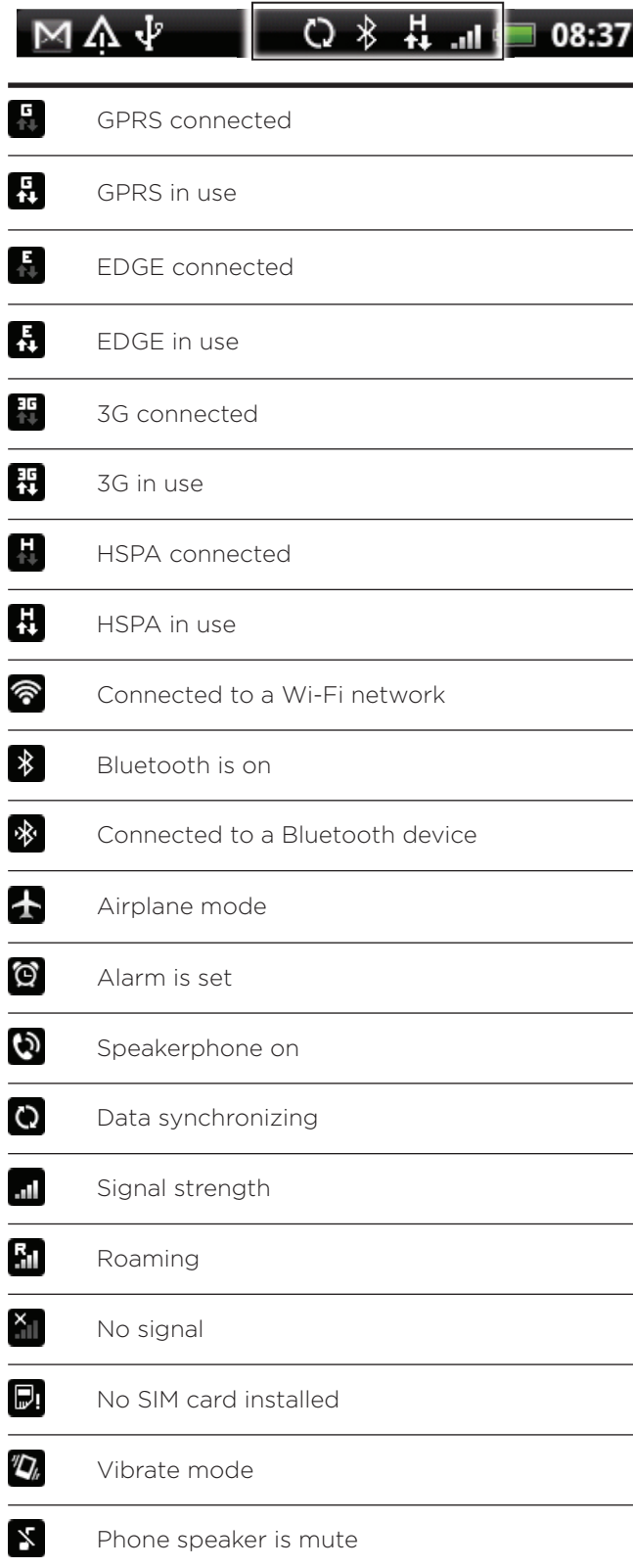











2. Tap the screen you want to open.







Phone status and notifications

Phone status icons

These are the icons that may appear on the phone status area of the status bar:































	GPRS connected
	GPRS in use
	EDGE connected
	EDGE in use
	3G connected
	3G in use
	HSPA connected
	HSPA in use
	Connected to a Wi-Fi network
	Bluetooth is on
	Connected to a Bluetooth device
	Airplane mode
	Alarm is set
	Speakerphone on
	Data synchronizing
	Signal strength
	Roaming
	No signal
	No SIM card installed
	Vibrate mode
	Phone speaker is mute

	Phone microphone is mute
	Battery is very low (10% remaining)
	Battery is low (20% remaining)
	Battery is full
	Battery is charging
	Wired microphone headset connected
	Wired headset connected

Notification icons

These are the icons that may appear on the notifications area of the status bar:

	
	New Gmail/Google Mail message
	New Microsoft Exchange ActiveSync or POP3/IMAP email
	New SMS/MMS
	Problem with SMS/MMS delivery
	New Google Talk instant message
	New voicemail
	Upcoming event
	Song is playing
	General notification (for example, Phone connected to computer via USB cable.)
	Storage card is low on free space
	Wi-Fi is on and wireless networks are available
	Data synchronizing or connected to HTC Sync
	New tweet
	FM Radio application in use

	More (not displayed) notifications
	Call in progress
	Missed call
	Call on hold
	Call forwarding on
	Compass needs orientation
	Uploading data (animated)
	Downloading data (animated)
	Waiting to upload
	Downloaded Android Market application installed successfully
	Update available for an application downloaded from Android Market
	Storage card is safe to remove or storage card is being prepared
	No storage card installed on the phone

Checking notifications

Notification icons on the status bar report the arrival of new messages, calendar events, alarms set and ongoing settings such as when call forwarding is on or the current call status. You can open the Notifications panel to open the message, reminder, or event notification and see the mobile operator name.

Opening the Notifications panel

When a new notification icon displays in the status bar, press and hold the status bar, then slide your finger downward to open the Notifications panel.

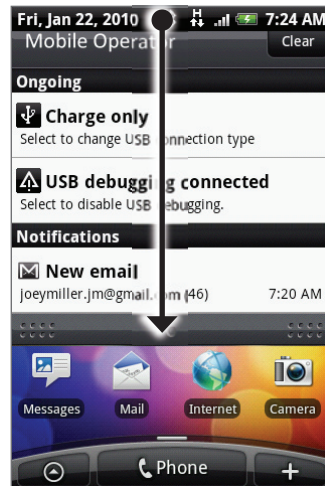

If you have several notifications, you can scroll down the screen to view more notifications.



You can also open the Notifications panel on the Home screen by pressing MENU and then tapping Notifications.

Closing the Notifications panel



Do one of the following:

- Press and hold the bottom bar of the Notifications panel, then slide your finger up the screen.
- Press BACK.

Adjusting the volume

Adjusting the ringer volume changes the volume level of the phone ring tone, whereas adjusting the media volume changes the volume level of sound notifications, music or video playback. The ringer volume and media volume can be separately adjusted.

Adjusting the ringer volume

1. Press the VOLUME UP or VOLUME DOWN buttons on the left panel of the phone to adjust the ringer volume to your desired level. The Ringer volume window appears on the screen to display the volume levels. While in the lowest ringer volume level (Silent mode), press VOLUME DOWN once to set your phone to Vibrate mode. The phone vibrates and the vibrate mode icon () appears on the status bar.
2. While in Vibrate mode, press VOLUME UP once to switch to silent mode. The speaker mute icon () displays on the status bar.



To quickly switch your phone to silent mode, press and hold the POWER button, and then tap **Silent mode** on the options menu.

Adjusting the media volume

When playing music or watching video, press the VOLUME UP or VOLUME DOWN buttons on the left panel of the phone to adjust the media volume. The Music/video volume window appears on the screen to display the volume level.

You can also adjust the media volume on the Settings screen.

1. Press HOME > MENU, and then tap **Settings > Sound & display > Media volume**.
2. When the Media volume window appears, drag the slider to the left to lower the volume or to the right to increase the volume.
3. Tap OK to close the window.

Connecting your phone to a computer

Whenever you connect your phone to a computer using the USB cable, the Connect to PC dialog box displays and prompts you to choose the type of USB connection. Select one of the following choices, and then tap **Done**:

Charge only

Select this mode if you only want to charge the phone's battery using your computer.

HTC Sync

When selected, the phone automatically uses HTC Sync when connected to your computer and lets you synchronize Outlook and Windows Address Book (Outlook Express), contacts and calendar events between your computer and your phone. For more information, see "Using HTC Sync" in the Accounts and sync chapter.

Disk drive

This mode is available only when you have installed a microSD card on your phone. Select this mode when you want to use your storage card as a USB thumb drive, and copy files between your phone's storage card and your computer.

When Disk Drive mode is enabled while your phone is connected to the computer, you will not be able to run applications that use the storage card, such as Music or Photos. For more information, see "Copying files to and from the storage card" in this chapter.

Internet sharing

When you do not have Internet connection on your computer, you can select this mode to share your phone's mobile data connection with your computer. For more information, see "Using Your Phone as a Modem" in the Internet chapter.



If you do not want to show the Connect to PC dialog box everytime you connect the phone to the computer, clear the **Ask me** checkbox in the Connect to PC dialog box. The default connection type will be used when you connect the phone to the computer.

To check or change the default connection type and to show or hide the Connect to PC dialog box, press HOME > MENU, and then tap **Settings > Connect to PC**.

Copying files to and from the storage card

1. Connect the phone to your computer using the supplied USB cable.
2. When the Connect to PC dialog box appears, tap **Disk drive**, and then tap **Done**.
3. On your computer, the connected phone is recognized as a removable disk. Navigate to this removable disk and open it.
4. Do one of the following:
 - Copy the files from the computer to the phone's storage card's root folder.
 - Copy the files from the phone's storage card to a folder in your computer or computer desktop.
5. After copying the files, unmount the removable disk (that is, the connected phone) as required by your computer's operating system to safely remove your phone.
6. Do one of the following:
 - Disconnect the phone from the computer.
 - If you want to keep the phone connected to the computer but want the phone to be able to access the storage card, open the Notifications panel, tap **Disk drive**, select an option except **Disk drive**, and then tap **Done**. See "Opening the Notifications panel" in this chapter to learn how to open the Notifications panel.

Searching your phone and the Web

You can search for information on your phone and on the Web by using the **Quick Search Box**. Some applications, such as People or Mail, have their own search box, which you can use to search within those applications (the application's icon is at the left of the search box.)

Setting Web and Quick Search Box options

1. Press HOME > MENU, and then tap **Settings**.
2. Scroll down the screen, and then tap **Search**.
3. Tap Google search settings, and then do the following:
 - Select **Show web suggestions** if you want to include suggestions from Google when doing a search.
 - Select **Search history** to enable personalized search history. You need to sign in to your Google Account to use this feature. The **Show web suggestion** check box needs to be selected for this option to be enabled.

Press BACK when you are done.

4. Tap **Searchable items**, and then select the items you want included when doing a search.

Searching the Web and your phone using the Quick Search Box

1. Press HOME > SEARCH.



If you are in an application such as Mail, press the SEARCH button to toggle between doing a search in the application only and searching your phone and the Web.

2. Enter the search item in the Quick Search Box. As you type, matching items on your phone and suggestions from Google web search are shown as a list.



The suggested items that appear will depend on the options that you have selected in the search settings. See “Setting Web and Quick Search Box options” for details.

3. Do one of the following:
 - If what you're searching for is in the list of suggestions, tap it in the list. The item opens in the appropriate application.
 - If what you're searching for is not in the list, tap  to search the Web. The web browser opens, displaying results of a Google search on the Web.

Personalizing

Making your phone truly yours

Make your phone look and sound just the way you want it. Personalize your phone with a different wallpaper, ringtone, and notification sound for events such as incoming text, email, calendar reminders, and more.

Your phone's Home screen is highly customizable and extends beyond the screen width, giving you plenty of space to add the information that matters most in your daily life and phone features that make communication quicker and easier. You have up to seven screens that extend to the left and right sides of your display as your Home screen, on which you can add elements such as widgets, program icons, shortcuts to information, and more.



To find out how to set notification sounds for events, see “Changing sound settings”.

Changing the ringtone

Choose from the available selections of ringtones on your phone. You can also download or copy ringtones or songs to your phone's storage card and choose one to use as your ringtone. To find out how you can copy files to your storage card, see “Copying files to and from the storage card”.

1. Press HOME > MENU, and then tap **Settings**.
2. Tap **Personalize > Default ringtone**.
3. Tap the ringtone you want to use. The ringtone briefly plays when selected.
4. Tap **OK**.



See “Specifications” for a list of audio file formats supported by your phone.

Personalizing your phone with scenes

Your phone becomes multiple phones in one when you use scenes. Scenes are personalized Home screen layouts that you can quickly apply to your phone. By switching between scenes, you instantly turn your phone into your perfect weekend phone, travel phone, work phone, or pure play phone.

Using a preset scene

Your phone features preset scenes, each preconfigured with a different wallpaper and collection of widgets that reflect different moments in your life. You can choose a scene that is suitable for work, play, travel, or your social life.

1. Press HOME > MENU, and then tap **Scenes**.
2. In the Choose a scene menu, select a preset scene and then tap **Done**.

Customizing and saving a scene

After selecting a preset scene, you can add widgets and other elements, arrange the layout, change the wallpaper, and save the whole Home screen as your personalized scene.

1. Press HOME > MENU, and then tap **Scenes**.
2. In the Choose a scene menu, select a preset scene that already has some widgets, or select **Clean Slate** if you want to design your own Home screen.
3. Add widgets and other elements that you want.
4. Arrange the layout of your Home screen according to your preference.
5. Change the Home screen wallpaper. You can also change the lock screen wallpaper.
6. When you are done designing your Home screen, press HOME > MENU and then tap **Scenes** again.
7. Under **My scenes**, make sure the **Current (unsaved)** option is selected and then tap **Save**.
8. Enter a new scene name for your Home screen and then tap **Done**. Or, if you already created a scene, enter the same scene name, tap **Done** and then tap **Replace**.

Renaming or deleting a scene

You can rename or delete a personalized scene that you created. Preset scenes cannot be renamed or deleted.

1. Press HOME > MENU and then tap **Settings > Personalize > Scenes**.
2. Under **My scenes**, press and hold a scene and choose whether to rename or delete it.

Changing your wallpaper

Personalizing your Home screen wallpaper with your favorite photo is a quick and easy way to change the feel of your phone and give it a fresh look. Browse the collection of wallpapers included in your phone or choose from photos that you have taken with the camera.

You can also change the lock screen wallpaper.

Changing your Home screen or lock screen wallpaper

1. Press HOME > MENU, and then tap **Wallpaper**.
2. Choose whether to change the **Home** or **Lock screen** wallpaper.
3. Do one of the following:
 - Tap **Photos** to select a photo that you have taken using the camera or copied to your storage card. Crop the photo and then tap **Save**.
 - Tap **Wallpaper gallery** to choose from preset wallpapers and then tap **Set wallpaper**.
4. After changing the Home screen or lock screen wallpaper, remember to save it to the scene that you created or save it as a new scene. To find out how to save a scene, see “Customizing and saving a scene”.

Personalizing your Home screen with widgets

Widgets put at-a-glance important information and media content up front on your Home screen. Some widgets are already added to your Home screen for your convenience. You can add more from the available selections of widgets, or download more widgets.

Adding a widget to your Home screen

A wide selection of widgets is available for you to choose from, such as Calendar, Music, Photo Album, Friend Stream, Twitter, and more.

1. Press HOME. Go to the part of the Home screen where there's space to add a new widget. To find out how, see "Navigating the Home screen".
2. Tap  or press and hold on the Home screen to open the Add to Home options menu.
3. Tap **Widget** and then select a widget that you want.
4. Most HTC widgets are available in a variety of designs and sizes to suit your needs. Tap the right or left arrow button at the bottom of the screen to view the different styles, and then tap **Select** to choose one.

You can also add widgets that allow you to quickly switch on or off certain settings of your phone, such as Wi-Fi, Mobile Network, Bluetooth, and more. Scroll down the widgets list, tap **Settings**, and then tap the widget that you want.

Downloading HTC widgets

A selection of fun and useful HTC widgets are also available for download.

1. Press HOME. Go to the part of the Home screen where there's space to add a new widget. To find out how, see "Navigating the Home screen".
2. Tap  or press and hold on the Home screen to open the Add to Home options menu.
3. Tap **Widget** and then tap **Get more HTC widgets**.
4. Tap to select a widget.
5. Tap **Details** to see a short description about the widget. After reading, press BACK.
6. When you're ready to download and add the widget to your Home screen, tap **Download**.

Adding application icons and other shortcuts on your Home screen

Place application icons on your Home screen to open applications quicker. You can also add shortcuts to settings and specific information such as a bookmarked webpage, someone's phone number, a music playlist, route directions, and many other items, to your Home screen.



The shortcuts available depend on the applications that are installed on your phone.

1. Press HOME. Go to the part of the Home screen where there's space to add a new shortcut. To find out how, see "Navigating the Home screen".
2. Tap  or press and hold on the Home screen to open the Add to Home options menu.
3. Do one of the following:
 - To add an application icon, tap **Program** and then select an application.
 - To add a shortcut to a setting or information, tap **Shortcut** and then select the type of information or setting.



To add an application icon on the Home screen, you can also press HOME, tap , and then press and hold an application icon. Without lifting your finger, drag the icon to an empty area on the Home screen, and then release it.

Adding folders on your Home screen

Use folders to group related applications and other shortcuts to keep your Home screen tidy and organized.



You can also add information folders that show up-to-date information such as Bluetooth received files, your Facebook phonebook, and more.

Creating a new folder and adding items to it

1. Press HOME. Go to the part of the Home screen where there's space to add a new folder. To find out how, see "Navigating the Home screen".
2. Tap  or press and hold on the Home screen to open the Add to Home options menu.
3. Tap **Folder** and then tap **New Folder**.
4. Press and hold an application icon or a shortcut that you want to move to the folder. The phone then vibrates. Don't lift your finger.
5. Drag the application icon or shortcut and drop it on top of the folder.

Simply tap the folder to open it so you can access the applications and shortcuts inside the folder.

Renaming a folder

1. Tap the folder to open it.
2. Press and hold the folder window's title bar.
3. Enter a new folder name and then tap **OK**.

Rearranging or removing widgets and icons on your Home screen

Rearrange the widgets and icons on your Home screen to give room for adding more items to the Home screen. You can also remove widgets and icons that you don't frequently use.

Moving a widget or icon

1. Press and hold the widget or icon you want to move.

The phone vibrates and you'll see a green box around the widget or icon. Don't release your finger.

2. Drag the widget or icon to a new location on the screen.

Pause at the left or right edge of the screen to drag the widget or icon onto another Home screen panel.

3. When the widget or icon is where you want it, release your finger.

If you've released your finger but a message shows that there's no space to place the widget or icon, drag it right or left again to another Home screen panel.

Removing a widget or icon

1. Press and hold the widget or icon you want to remove.

The phone vibrates and you'll see a green box around the widget or icon. Don't release your finger.

2. Drag the widget or icon to the **Phone** button. The **Phone** button then changes into the **Remove** button and turns red.

3. When the widget or icon also turns red, release your finger.

Phone calls

Making calls

There are several convenient methods to make a call from your phone.



Most SIM cards are preset with a PIN (personal identification number) that is provided by your mobile operator. When prompted, enter the preset PIN, then tap Enter. If you enter the wrong PIN three times, the SIM card is blocked. If this happens, you can unblock it with the PUK (PIN Unblocking Key) obtained from your mobile operator. See “Restoring a SIM card that has been locked out” in the Security chapter for details.



The two prongs underneath the bottom cover act as the antenna for your phone. It is recommended that you secure the bottom cover to the phone to ensure that you get the best radio reception for your phone. To learn how to secure the bottom cover, see “Replacing the bottom cover” in the Basics chapter.

Calling somebody using your phone

You can either dial a number directly, or you can use the Smart Dial (see Smart Dial) feature to search and call a contact in your contacts list or a number from call history.

1. Press HOME, and then tap **Phone**.
2. Begin entering the first few digits or characters by tapping the keys on the phone keypad. As you enter digits or letters, the panel displays numbers and names that match the keys you tapped.

If you enter a wrong digit, tap to erase that digit. To erase the entire number, press and hold .

3. Tap to close the phone keypad and to see if there are more matching numbers or contacts. To browse through the filtered list, flick through the list or slide your finger up or down the list slowly.
4. To place a call, do one of the following:
 - If there are no matching contacts in the list, after entering the number, tap **Call**.
 - Tap the phone number or contact from the list.
 - To call a different phone number associated with the contact, tap at the right side of the contact name. On the contact details screen, tap the number you want to call.

Smart Dial

The phone dialer’s Smart Dial feature makes it quick and easy for you to place a call. Simply enter the phone number or first few letters of the person you want to call. Smart Dial automatically searches and filters your contacts list (stored on your phone and SIM card) and the phone numbers from the call history.

Calling a speed dial number

1. Press HOME, and then tap **Phone**.
2. On the phone keypad, press and hold the number that is associated with the contact you want to call.

The number 1 on the phone keypad is generally reserved for your voicemail. Press and hold this button to call voicemail and retrieve your voicemail messages.

Adding a contact to speed dial

1. Press HOME, and then tap **Phone**.
2. Press MENU, and then tap **Speed dial > Add new**.
3. Enter the name of the contact you want to add. When the name comes up in the list, tap the name.
4. On the Speed dial screen, select the phone number of the contact to use, and the phone keypad assignment. Tap **Save**.

Calling a phone number in a text message

1. Press HOME, tap **Messages**, and then tap the message with the phone number.
2. In the message thread, tap the message with the phone number.
3. On the **Select link** screen, tap the number you want to call.
4. Edit the phone number if needed, and then tap **Call**.



To call the message sender, in the All messages list, press and hold the message, and then tap **Call** on the options menu.

For more information about text messages, see the Messages chapter.

Calling a phone number in an email

1. Press HOME, and then tap **Mail**.
2. Open the email account where the email with the number is located.
3. In the email account's inbox, tap the email to open it.
4. In the email body, tap the phone number. The phone dialer screen opens with the phone number already entered.

The phone will recognize a number as a phone number if the number has a minimum of 5 digits and have at least one of the following:

- Numbers preceded by a "+" in front. For example, +1-987-654-321 or +1987654321.
- Numbers enclosed in parenthesis in front. For example, (02)987654321 or (02)987-654-321.
- Numbers separated by dashes. For example, (02)-987-654-321 or 0987-654-321.

5. Tap **Call**.

For more information about email, see the Email chapter.

Making an emergency call

You can make emergency calls from your phone even if you don't have a SIM card installed or your SIM card has been blocked.

1. Press HOME, and then tap **Phone**.
2. Dial the international emergency number for your locale (for example, 000), and then tap **Call**.



Additional emergency numbers may be included in your SIM card. Contact your mobile operator for details.

If you enabled the unlock screen pattern and/or the SIM lock, and you forgot the unlock pattern or SIM PIN, you can still make emergency calls by tapping **Emergency call** on the screen.

Receiving calls

When you receive a phone call from a contact, the Incoming call screen appears and displays the caller ID icon, name, and phone number of the calling party. When you receive a phone call from someone who is not stored in People, only the default caller ID icon and phone number appear on the Incoming call screen.

Answering an incoming call

Depending if the display is on or off, you need to:

- If the display is on, tap **Answer**.
- If the display is off, the display will turn on showing the Lock screen. Drag the bar down to answer the call.



Muting the ringing sound without rejecting the call

Do one of the following:

- Press the VOLUME DOWN button.
- Place the phone face down on a leveled surface.



If the phone is already facing down, the phone will still ring when there are subsequent incoming calls.

Automatically scaling down the ring volume when picking up the phone

You can set your phone to automatically scale down the ring volume when you pick up the phone to answer calls.

1. Press HOME, and then tap **Settings > Sound & display**.
2. Scroll down the screen, and then select the **Quiet ring on pickup** check box.
3. Press BACK.

Rejecting an incoming call

Depending if the display is on or off, you need to::

- If the display is on, tap **Decline** to reject and send the call to your voice mail.
- If the display is off, the display will turn on showing the Lock screen. While the Lock screen is showing, drag the bar up to reject and send the call to your voicemail.
- If the display is off, the display will turn on showing the Lock screen. While the Lock screen is showing, press MENU, and then tap **End call** to reject and send the call to your voicemail.

Rejecting a call and sending a text message

You can automatically send a default text message to the caller and reject the incoming call.

To reject and send a message when you receive an incoming call, press MENU, and then tap **Send message**.

Editing the default message

You can change the message that is sent out.

1. Press HOME, and then tap **Phone**.
2. Press MENU, and then tap **Phone settings > Edit default message**.
3. Enter the new message, and then tap **OK**.

Using in-call options



When a call is in progress, use the buttons onscreen to mute or unmute the microphone or to turn on or off the speakerphone. You can also press MENU to open the call options to let you add a call, place the call on hold, mute the microphone, and more.

Handling multiple calls

Your phone notifies you when you have another incoming call, and gives you the option of rejecting or accepting the call. If you are already on a call and accept the new call, you can choose to switch between the two callers.



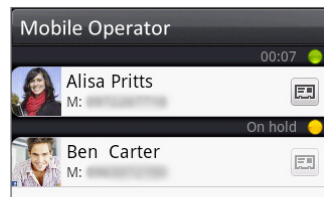

1. When you receive another call, tap **Answer** to accept the second call, and to put the first call on hold.
2. To switch between callers, tap the person you want to talk to on the screen.



3. To end the current call and return to the other call, tap **End call**.

You can start a conference call between all parties by merging the calls. To merge the call, tap  at the bottom right of the screen.

Setting up a conference call

1. Make a call to the first conference call participant.
2. When connected, press MENU, tap **Add call**, and then dial the number of the second participant. The first participant is put on hold when you dial the second participant.
3. When connected to the second participant, tap  (merge).
4. To add another participant to the conference call, tap  on the conference call screen, and then dial the number of the contact you want to invite to the conference call.
5. When connected, tap  to add the participant to the conference call.
When you want to talk to a person in the conference call in private, tap , and then select **Private call** on the options menu.
6. When finished, tap **End call**.





Not all mobile networks support conference calling. Contact your mobile operator for details.



Putting a call on hold

Press MENU and then tap **Hold** to put the call on hold. When you put a call on hold, the Hold call icon () appears in the status bar. Press MENU, and then tap **Unhold** to resume the call.

Muting the microphone during a call

On the screen, tap  to toggle between turning the microphone on or off. When the microphone is turned off, the Mute icon () appears in the status bar.

Turning the speakerphone on or off during a call

On the screen, tap  to toggle between turning the speakerphone on or off. The speakerphone icon () appears in the status bar when the speakerphone is on.



To avoid damage to your hearing, do not hold your phone against your ear when the speakerphone is turned on.

Ending a call

Do one of the following to end the call:

- On the screen, tap **End call**.
- If you are using the provided wired headset, press and hold the button to end the call.

If the phone number of the person who called is not in your contacts list, you can choose to save the number to your contacts list after you hang up.

Using call history

When you miss a call, the missed call icon () appears in the title bar. Use the **Call history** tab in the People application to check who the caller was or view all your dialed numbers and received calls.

1. Press HOME, and then tap **Phone**.
2. Tap  at the bottom-right corner of the screen.
3. Do one of the following:
 - Tap the name or number in the list to call.

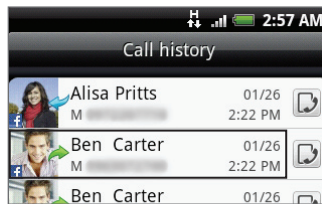

- Press and hold a name or number in the list to display the options menu where you can select to view the contact information (if the number is stored in your contacts list), edit the number before you redial, send a text message, or delete from call history.

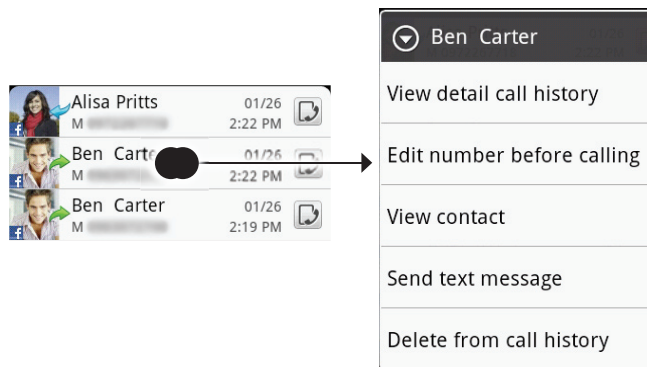

- Tap  to show the call history for that particular contact.



You can also access call history from the People application. See the People chapter for more information.

Adding a new phone number to your contacts from call history



1. Press HOME, and then tap **Phone**.
2. Tap  at the bottom-right corner of the screen.
3. Press and hold the received call, number that is not in your contacts list, that you want to save to your contacts list, and then tap **Save to contacts**.
4. In the blank contact record that appears, enter the contact name and other information. The phone number is automatically added to the **Mobile** field in the Phone section. To store it as another type of number, for example a home number, tap the **Mobile** button.
5. Scroll down the screen and tap **Save**.



To learn how to add new contacts or edit the contact information, see the People chapter.

Checking a missed call

You will see the missed call icon  in the status bar when you miss a call.

1. Press HOME, and then tap **Phone**.
2. Tap  at the bottom-right corner of the screen.
3. In the call history list, missed calls are indicated by the missed call icon ().



You can also press and hold the status bar, and then slide your finger downward on the screen to open the Notifications panel. The missed call number or contact name is displayed.

Clearing the call history list

1. Press HOME, and then tap **Phone**.
2. Tap  at the bottom-right corner of the screen.
3. Do one of the following:
 - To remove one name or number from the list, press and hold the name or number, and then tap **Delete from call history**.
 - To clear the entire list, press MENU, and then tap **Delete all**.

Call services

Your phone can directly link to the mobile phone network, and enable you to access and change the settings of various phone services for your phone. Call services may include call forwarding, call waiting, voicemail, and more. Contact your mobile operator to find out about the availability of call services for your phone.

To open call services, press HOME > MENU, and then tap **Settings > Call**.

Fixed Dialing Numbers

Restrict outgoing calls to a fixed set of numbers. To enable this feature, you must know your SIM card's PIN2 code.

Voicemail service

Shows the current voicemail service being used.

Voicemail settings

Specify another voice mail number aside from the voice mail number on your SIM card.

Clear voicemail notification

If you have a notification of a new voicemail, you can clear the notification with this option.

Phone settings

Edit the call reject message, choose whether to open the message editor when you reject a call with a message, and choose whether to allow automatic saving of an unknown contact number when a call with that number ends.

Cell broadcast

Enable or disable receipt of cell broadcast messages from your service provider.

Cell broadcast settings

Configure channels and language for cell broadcast messages.

Call forwarding

Select how you want your phone to handle busy, unanswered, and unreachable calls. You can also set the call forwarding option for all incoming calls.

Call barring settings

Choose whether to block various categories of incoming and outgoing call.

Additional call settings

Enable or disable operator services such as caller ID and call waiting.

Turning Airplane mode on or off

In many countries, you are required by law to turn off the phone while on board an aircraft. A way to turn off the phone function is to switch your phone to **Airplane mode**. When you enable Airplane mode, all wireless radios on your phone are turned off, including the call function, data services, Bluetooth, and Wi-Fi.

1. Press HOME > MENU, and then tap **Settings > Wireless & networks**.
2. Select or clear the **Airplane mode** check box to enable or disable Airplane mode. When enabled, the Airplane mode icon () is displayed in the status bar.



When you disable Airplane mode, the call function is turned back on and the previous state of Bluetooth and Wi-Fi is restored.

People

About People

In **People**, you can easily manage your communications with contacts via phone, messaging, and email. You can also view updates on their Facebook and Flickr accounts.

If you are synchronizing contacts with your Google account, with your PC, and/or with an Exchange Server, any contacts stored in those accounts are displayed in People. You can also synchronize contacts from your Facebook account in People. For more information on synchronizing accounts, see “Ways of getting contacts into your phone” in this chapter.

Ways of getting contacts into your phone

You can add contacts to your phone from:

- **Gmail/Google Mail contacts** Gmail/Google Mail contacts are imported to your phone after you set up a Google Account. For details, see the “Gmail/Google Mail” in the Email chapter.
- **Phone contacts** See “Adding a new contact” in this chapter for details.
- **Exchange ActiveSync Server** See “Synchronizing with a Microsoft Exchange ActiveSync account” in the Accounts and sync chapter for details.
- **Contacts on your computer** See “Using HTC Sync” in the Accounts and sync chapter for details.
- **SIM card** See “Importing contacts from your SIM card” in this chapter for details.
- **Facebook** See “Adding an account” in the Accounts and sync chapter for details.

People screen

The People screen gives you easy access to all your contacts, as well as even faster access to the people and groups of people you contact most often.

The People screen has the following tabs:

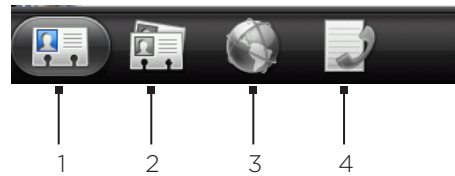

1 All tab

Gives you access to all contacts on your phone, including Google contacts, Exchange ActiveSync contacts, Phone contacts, contacts stored on your SIM card, and Facebook contacts. You can also use this tab to open or update My contact card. For more information, see “Setting up My Contact Card” in this chapter.

2 Groups tab

Lets you assign contacts to groups so you can easily send an SMS, MMS, or email message to a whole group. For more information, see “Contact groups” in this chapter.

3 Online directories tab

Search for contacts on your online directories such as your Exchange ActiveSync or Facebook account to copy to your phone.

4 Call history tab

Lists all your dialed numbers and received and missed calls. See “Using Call History” in the Phone calls chapter.

Setting up My contact card

My contact card provides a convenient way to store your personal contact information so that you can easily send it via SMS, MMS, email, or Bluetooth.

1. Press HOME, and then tap  > People.
2. On the All tab of the People screen, tap Me, and then tap **Tap here to edit contact**.



If you are logged in to your Facebook account through Facebook for HTC Sense, instead of Me, you will see your the name you use in Facebook.

3. Enter your name and contact details.
4. Tap Save.

Your contacts list

The All tab of the People screen shows all your contacts, including Google contacts, Exchange ActiveSync contacts, Phone contacts, contacts stored on your SIM card, and Facebook contacts.



If you signed in to your Google Account and Facebook account when you first set up the phone, your contacts from those accounts will appear in the contacts list when you open People.

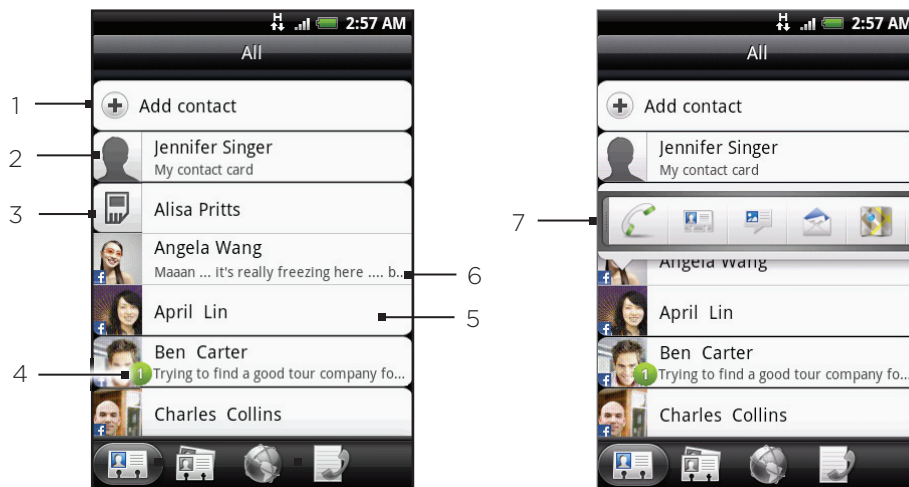

-
- 1 Create a new contact.
 - 2 Tap to edit your My contact card.
 - 3 SIM card contact
 - 4 This icon appears when the contact:
 - Has sent you a new text or email message, or tried to call you but you missed the call.
 - Has updated his or her Facebook profile or has added photos on Flickr or Facebook.
 - Has upcoming Facebook events.
 - 5 Tap to open the contact details screen for that contact.
 - 6 This appears when the contact is a Facebook contact or you link the contact to his or her Facebook account.
 - 7 Tap the photo or icon to open a menu where you can quickly choose how to communicate with the contact. Depending on the contact information stored, you can call, send a message or email, see the contact's Facebook profile, and map his/her address in Google Maps.
-



To view only contacts of a particular type, for example Google contacts or Facebook contacts, press MENU, tap View, and select the contact types.

Adding a new contact

1. Press HOME, and then tap  > People.
2. On the All tab, tap Add contact at the top of the screen.
3. Select the **Contact account**, for example Google or Microsoft Exchange ActiveSync. This determines which account the contact will sync with. For more information, see “Ways of getting contacts into your phone” in this chapter.
4. Do one of the following:
 - For Google, Exchange or Phone contact type, tap the **Name** field, enter the first and last name of the contact, and choose the order in which to display the names. Tap OK.
 - For SIM contact type, tap the **Name** field, and then enter the name.
5. Enter the contact information in the fields provided.
6. Scroll to the bottom of the screen, and then tap Save.

Importing contacts from your SIM card

You can copy all your SIM contacts to your phone. You can import them as Phone contacts, Google contacts, or Exchange ActiveSync contacts, if you have set up the relevant accounts.

1. Press HOME, and then tap  > People.
2. On the All tab, press MENU, and then tap **Import/Export** > **Import from SIM card**.
3. If you have Google or Exchange ActiveSync accounts set up on your phone, tap the type for the imported contacts.
4. Do one of the following:
 - To import all contacts, press MENU, and then tap **Import all**.
 - To import a contact, tap the contact on the screen.

Importing contacts from online directories

Access contacts from your online accounts and copy them to the phone.





1. Press HOME, and then tap  > People.
2. On the **Online directories** tab, select the account where you want to copy contacts from.
3. Search for the contact you want to copy to your phone.
4. Tap **Save to People**.

Merging contact information



Merge duplicated contacts on your phone to avoid clutter and confusion. If you have the same contact appear in your Phone, Google, and Facebook accounts, you can merge the contact information into one contact.

The phone automatically merges contacts that it finds to have similar data. If you need to manually merge contacts or break the link between contacts, follow the procedures below.

Manually merging contact information

1. Press HOME, and then tap  > People.
2. On the **All** tab, tap the name of the contact (not the icon or photo) you want to merge with another contact on your phone.
3. At the upper right corner of the screen, tap  or  (if there are suggested links.)
4. On the screen, you can:
 - If there are suggested links, tap  to link the contact to the selected account.
 - Tap one of the options available in the **Add contact** section.
5. Tap **Done**.

Breaking the contact information link between contacts

1. Press HOME, and then tap  > People.
2. On the All tab, tap the name of the contact (not the icon or photo) whose contact information link you want to break.
3. On the upper right corner of the screen, tap .
4. On the **Linked contacts** section, tap  beside the name of the contact to break the link.
5. Tap Done.

Editing a contact's information

1. Press HOME, and then tap  > People.
2. On the All tab, press and hold the contact, and then tap **Edit contact**.
3. Enter the new information for the contact.
4. Scroll to the bottom of the screen, and then tap **Save**.

Searching for a contact

1. Press HOME, and then tap  > People.
2. Press the SEARCH button on the phone.
3. In the search bar, enter the first few letters of the first or last name of the contact you are looking for. Matching contacts are displayed.



If the list of matching contacts is long, you can view more results by tapping  to hide the onscreen keyboard.

4. Tap the contact to open his or her contact details screen. See “Contact information and conversations” in this chapter for details.

Backing up your contacts to the storage card

1. Press HOME, and then tap  > People.
2. Press MENU, and then tap **Import/Export** > **Export to SD card**.
3. When asked to confirm, tap **OK**.

Importing contacts from the storage card

1. Press HOME, and then tap  > People.
2. Press MENU, and then tap **Import/Export** > **Import from SD card**.



You can only import contacts that were exported to the storage card using the **Export to SD card** feature on the phone. See “Backing up your contacts to the storage card.”

3. If you have Google or Exchange ActiveSync accounts set up on your phone, tap the type for the imported contacts.



Press **BACK** to stop importing contacts from the storage card.

Deleting contacts

1. Press HOME, and then tap  > People.
2. On the All tab, press MENU, and then tap **Delete contacts**.
3. Select the contacts you want to delete, and then tap **Delete**.
4. When prompted, tap **OK**.

Sending contact information as a vCard via MMS

1. Press HOME, and then tap  > People.
2. On the All tab, press and hold the name of the contact (not the icon or photo) whose contact information you want to send, and then tap **Send contact as vCard**.
3. Select the type of information you want to send, and then tap **Send**.
4. Enter the recipient's number or email address, and then tap **Send**.



You cannot send a vCard using SMS.

You can also send the vCard via Bluetooth. To learn how to send files through Bluetooth, see the Bluetooth chapter.

Sending your contact information as a vCard via MMS

1. Press HOME, and then tap  > People.
2. On the All tab, tap [Your name] My contact card.
3. Press MENU, and then tap **Send my contact info**.
4. Select the type of information you want to send, and then tap **Send**.
5. Enter the recipient's number or email address, and then tap **Send**.



You cannot send a vCard using SMS.

You can also send your contact vCard via Bluetooth. To learn how to send files through Bluetooth, see the Bluetooth chapter.

Contact groups

On the **Groups** tab, you can assign contacts to groups so you can easily send an SMS, MMS, or email message to a whole group. You can also sync groups on your phone with the groups in your Google account, accessible via your computer's web browser.

Creating a group and adding contacts

1. Press HOME, and then tap  > People.
2. On the **Groups** tab, at the top of the screen, tap **Add group**.
3. Enter a name for the group, and then tap **Add contact to group**.
4. Select the contacts you want to add to the group, and then tap **Save**.



If your contacts list is long, you can use the search bar to search for contacts quickly, or tap  to hide the onscreen keyboard and scroll through the list.

5. Tap  to add a group from photo.
6. Tap **Save**.



Deleting a group

1. Press HOME, and then tap  > People.
2. On the **Groups** tab, press and hold the group you want to delete, and then tap **Delete group**.



You can only delete groups that you have created.

Adding or removing contacts from a group

1. Press HOME, and then tap  > People.
2. On the **Groups** tab, press and hold the group, and then tap **Edit group**.
3. You can:
 - Tap the group name to change the name. You can only change the name for groups that you have created.
 - Tap the icon to the left of the group name to change or remove the group photo.
 - To add contacts to the group, tap **Add contact to group**, select the contacts you want to add, and then tap **Save**.
 - To remove a contact from the group, tap  at the right side of the contact name, and then tap **Save**.

Sending an SMS/MMS message or email to a group

1. Press HOME, and then tap  > People.
2. On the **Groups** tab, tap the group you want to send an SMS/MMS message or email to.
3. Go to the **Group action** tab, and then do one of the following:
 - Tap **Send group message** to send an SMS/MMS message to the group. For information about composing and sending messages, see the Messages chapter.



You will be charged by your mobile provider for each message sent. For example, if you send a message to a group of five people, you will be charged for five messages.

- Tap **Send group mail** to send an email to the group. For information on composing and sending email, see the Email chapter.

Contact information and conversations

When you tap a contact on the People screen, the contact details screen opens, showing you the information stored for that contact, exchanged messages and phone calls with that contact, Facebook notifications, and more.

The contact details screen has the following tabs:

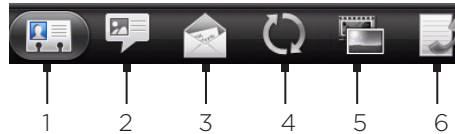

1 Details tab

Shows the information you have stored for the contact, and allows you to get in touch with the contact directly by tapping any of the displayed methods. For example, if the contact has a stored work phone number, tap **Call Work** to call that number.

You can also add one of the contact's phone numbers as a speed dial number. For information, see "To add a contact to speed dial" in this chapter.

2 Messages tab

Shows your exchanged SMS messages with the contact. Tap a message to view it. To send a new message, press MENU and tap **Send message**. For more information about messages, see the Messages chapter.

3 Mail tab

Shows email messages you have received from the contact. Tap an email message to view it. To send a new email message, press MENU and tap **New mail**. For more information about email, see the Email chapter.

4 Updates and events tab

Shows the contact's Facebook status, updates, and events, and shows when he or she uploads new photos to Flickr. When there is a notification of the contact's birthday, you can tap the notification to call the contact directly or send a message greeting.

You need to be logged in to your Facebook account to see the updates and events. If you are not logged in, tap **Link to Facebook**.

5 Photos tab

Shows the contact's Facebook and Flickr photo albums. Tap an album to look at the photos in the album.

You need to be logged in to your Facebook and Flickr accounts to see the photo albums. If you are not logged in, tap **Link to Facebook** and/or **Link to Flickr**.

6 Call history tab

Lists all your incoming, outgoing, and missed calls to and from the contact. Tap a list item to call the contact using the displayed number.

People widget

Put the group of people you contact most right on the Home screen of your phone by adding them as the People widget. Using the People widget, you can instantly place a call, send a message, or view details of a favorite contact with a single tap.

Adding the People widget

Slide your finger left or right on the Home screen to find the People widget. If you do not find the People widget on the Home screen, follow this procedure to add the widget to the Home screen.

1. Press HOME, and then tap  > Widget > People.
2. Choose the widget style, and then tap **Select**.
3. Select the group you want to add as a widget.
4. Drag the widget to a blank space on a Home screen, and then release.

Setting the default communication method

1. Press HOME, and then go to the People widget.
2. Tap a contact on the widget.
3. On the Select default action screen, tap the communication method you want for the contact.

Changing the default communication method

If you want to change the default action for communicating with a contact on the People widget, you must first remove this contact from the group. Add this contact back to the group, and then choose the new communication method.

1. Remove the contact from the group. See “Adding or removing contacts from a group” for details.
2. Add the contact back to the group. See “Adding or removing contacts from a group” for details.
3. Choose the default communication method. See “Setting the default communication method” for details.

Getting in touch with a contact

1. Press HOME, and then go to the People widget.
2. Tap a contact (photo not the name) on the widget. The default communication method will be performed.



Tap the name of the contact to open the contact details screen for that contact.

If you have not set a default communication method, the Select default action screen will open. See “Setting the default communication method” in this chapter for details.

Keyboard

Using the onscreen keyboard

When you start a program or select a field that requires text or numbers, the onscreen keyboard becomes available.

Using the landscape onscreen keyboard

When entering text, you can choose to use the landscape orientation of the onscreen keyboard. Turn the phone sideways to use a larger keyboard that lets you type easily using two thumbs.

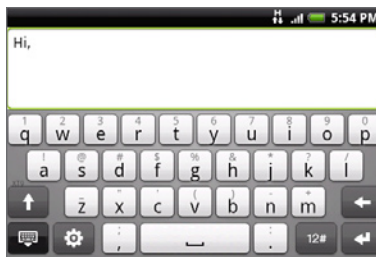

- The Orientation check box in HOME > MENU > Settings > Sound & display needs to be selected for the screen orientation to automatically change.
- The landscape orientation keyboard is not supported in all applications.

Changing the onscreen keyboard layout

You can choose from three different keyboard layouts to suit your typing style. To change the keyboard layout, do the following:

1. On the onscreen keyboard, tap .
2. Tap **Keyboard types**, and then select the keyboard layout that you want to use. Choose from the following:
 - **QWERTY**. This layout is similar to a desktop computer keyboard. This is the default keyboard layout.
 - **Phone Keypad**. This layout resembles the traditional mobile phone keypad.
 - **Compact QWERTY**. This layout features two letters on each key. The key size is slightly bigger than on the Full QWERTY layout.

Entering text

Use the following keys while entering text using the onscreen keyboard:



Press and hold keys with gray characters at the top to enter numbers, symbols, or accented letters. The gray character displayed on the key is the character that will be inserted when you press and hold that key. Some keys have multiple characters or accents associated with them.



This is the Shift key. Tap to enter an uppercase letter. The next letter you type will be uppercase. Tap twice to turn on caps lock.



Tap to switch to the numeric and symbol keyboard.



This is the Enter key. Tap to create a new line.



This is the Backspace key. Tap to delete the previous character.



Tap to hide the onscreen keyboard.



Tap to open the Touch Input settings menu to change the keyboard type, enable or disable predictive mode in the QWERTY keyboard, and adjust other input settings.



Tap to toggle between Multitap and XT9 predictive modes when using the Compact QWERTY or Phone keypad layout. For more information, see “Entering words with predictive text” below.

Entering words with predictive text

The onscreen keyboard has predictive text to help you type quickly and accurately. Predictive text input is enabled by default, and word suggestions are displayed as you type.

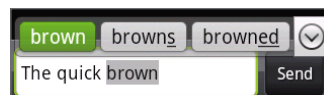

To enter a word in predictive mode, do any of the following:

- If you see the word you want highlighted in green or orange, you can simply tap the space bar to insert the word into your text.
- If you see the word you want shown in the suggestions before you have finished typing the entire word, tap the word to insert it into your text.
- If an arrow is shown to the right of the suggestion list, tap the arrow to see more suggestions.

Adding a word to the predictive text dictionary

Your phone comes with a list of words that it references for predictive text suggestions. Sometimes you may need to add a word to the predictive text dictionary, for example a name or a specialized technical word.

While entering text using the QWERTY keyboard layout, if you tap any word on the suggestion list, it is automatically added to the predictive text dictionary if it was not in the dictionary already.

You can also add a word to the list manually:

1. On the onscreen keyboard, tap .
2. Tap **User Dictionary**.
3. Tap **Add new**.
4. Enter the word to add, and then tap **OK**.

Editing or deleting a word in the user dictionary

You can edit or remove words that you previously added to the predictive text dictionary.

1. On the onscreen keyboard, tap .
2. Tap **User Dictionary**.
 - To edit a word, tap the word itself.
 - To delete a word, tap the **X** icon to the right of the word.

Adjusting touch input settings

Open the Touch Input settings by doing one of the following:

- On any of the keyboard layouts, tap  to open the Touch Input settings.
- On the Home screen, press MENU and then tap **Settings > Language & keyboard > Touch Input**.

Touch Input settings

Keyboard types

Tap to select the keyboard layout to use. You can choose from QWERTY, Phone Keypad, or Compact QWERTY.

Keyboard language

Tap to select the language layout of the keyboard.

Text input

Tap to set text input options when entering text, calibrate the keyboard, and set a sound and/or vibration feedback whenever you tap a key. See “Text input” below for details.

Tutorial

Learn how to use the onscreen keyboard with this interactive tutorial.

User Dictionary

Add, edit or remove words in the predictive text dictionary. See “Entering words with predictive text” in this chapter for more information.

Text input

QWERTY

Prediction

Select to enable the word prediction feature which provides a list of possible words that reflect the characters of the keys you have tapped as well as characters of nearby keys.

Spell correction

Select to correct typographical errors by selecting from a list of possible words that reflect the characters of the keys you have tapped as well as characters of nearby keys.

Phone keypad & compact QWERTY

Spell correction

Select to correct typographical errors by selecting from a list of possible words that reflect the characters of the keys you have tapped as well as characters of nearby keys.

Word completion

When using the Compact QWERTY or Phone keypad, lets you select from a list of possible combinations based on the characters that appear on the keys that you tapped.

Other settings

Sound feedback

Select to hear a clicking sound whenever you tap a key on the keyboard.

Vibrate when typing

Select to enable vibration feedback whenever you tap a key on the keyboard.

Finger touch precision

Calibration tool

Tap to re-calibrate the keyboard touch accuracy. Re-calibrate the keyboard if you feel that the keyboard keys are not responding accurately to your taps.

Reset calibration

Tap to reset the calibration back to factory default.

Messages

About Messages

Messages lets you compose and send text (SMS) and multimedia messages (MMS) to other mobile phones.

To open your message inbox, press HOME, and then tap  > Messages.

If the list of messages does not fit on the screen, you can scroll down to view more messages by swiping your finger on the screen or the optical trackball.

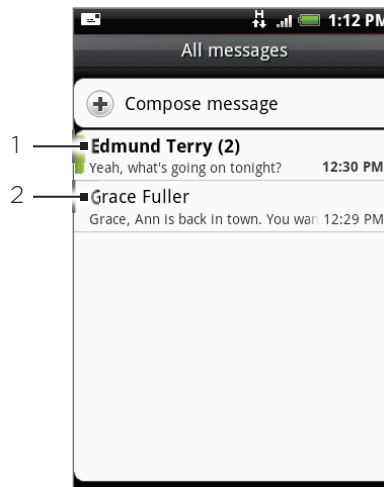

-
- 1 Bold text indicates unread messages in the thread.
 - 2 Tap to open the message or message thread and read the text or view the picture message..
-

Sending text and multimedia messages

Send short text messages (SMS) and multimedia messages (MMS) to other mobile phones. If you exceed the limit on the number of characters for a single text message, your text message will be delivered as one but will be billed as more than one message. These are called concatenated messages.

Multimedia messages can contain text and a picture, a recorded voice, an audio or video file, a picture slideshow, contact card (vCard), or appointment (vCalendar).



The Messages application automatically converts a text message into a multimedia message when you enter an email address in the To field, add a message subject, attach an item, or compose a very long message.

Sending a text message

1. Press HOME, and then tap  > Messages.
2. On the All messages screen, tap **Compose message**. The Compose screen opens.

3. Fill in one or more recipients. You can:
 - Enter phone numbers directly in the To field. If you're sending the message to several phone numbers, separate the phone numbers with a comma. As you enter information, any matching phone numbers from your contacts list are displayed. Tap a match to enter that number or address directly.
 - Tap the  icon, and then select the phone numbers of the contacts to whom you want to send the message. You can also select contact groups as recipients. When you have selected all the message recipients, tap **Done**.
4. Tap the text box that contains the text "Tap to compose", and then start composing your message.

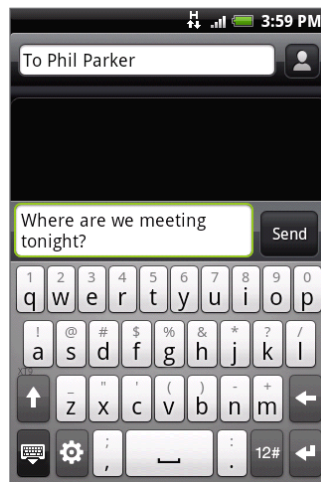



5. When done, tap **Send** to send the text message.



To receive delivery reports and know when a text message is received, in the All messages screen, press MENU and then tap **Settings**. In the SMS settings section, select the **Delivery reports** check box.

Sending a multimedia (MMS) message

1. Press HOME, and then tap  > Messages.
2. On the All messages screen, tap **Compose message**. The Compose screen opens.
3. Fill in one or more recipients. You can:
 - Enter phone numbers or email addresses directly in the To field. If you're sending the message to several recipients, separate the phone numbers or email addresses with a comma. As you enter information, any matching phone numbers or addresses from your contacts list are displayed. Tap a match to enter that number or address directly.
 - Tap the  icon, and then select the contacts to whom you want to send the message. You can also select contact groups as recipients. When you have selected all the message recipients, tap **Done**.





You can add a subject line by pressing MENU and then tapping **Add subject**.

4. Tap the text box that contains the text "Tap to compose", and then start composing your message.

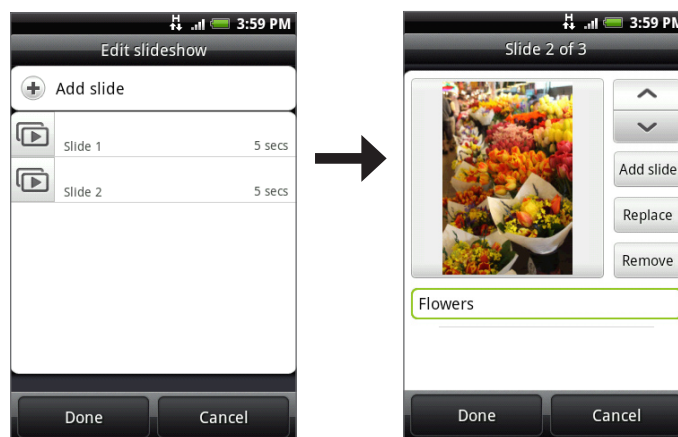
5. Press MENU and then tap **Attach**.
6. On the Attach window, select from the following file attachments:
 - **Picture**. Select **Camera** to take a photo and attach it, or **Pictures** to attach a photo from your storage card.
 - **Video**. Select **Camcorder** to capture a video and attach it, or **Videos** to attach a video from your storage card.
 - **Audio**. Select **Voice Recorder** to make a voice recording and attach it, or **Music & sounds** to attach a music file or voice recording from your storage card.
 - **Location**. You can attach location information. Send your current location (requires GPS to be turned on), a location stored in Footprints, or a location you pick on a map. For more information about GPS, maps, and Footprints, see the Maps and location chapter.
 - **Contact (vCard)**. Select a contact from your phone, and then select which contact information you want to attach.
 - **Appointment (vCalendar)**. Select the calendar event you want to attach.
 - **Slideshow**. Opens the Edit slideshow screen. Tap **Add slide** to create a new slide. Tap the created slide (for example, Slide 1), tap **Insert picture**, and then select the picture you want to add to the slide. You can also navigate to the text box and enter a caption for the picture. When finished, tap **Done** to attach the slideshow to your message.



- When editing multiple slides, tap  to edit the next slide or tap  to return to the previous slide.
- While editing the slideshow, press MENU to let you preview the slideshow, add music or video to a slide, remove a slide, and more.

7. When you have finished composing the multimedia message, tap **Send**.



To receive delivery reports and know when a picture message is received, in the All messages screen, press MENU, and then tap Settings. Select the **Delivery reports** check box in the MMS settings section.

Saving and resuming a draft message



While composing a text or multimedia message, press BACK to automatically save your message as a draft. To resume composing the message:

1. On the All messages screen, press MENU, and then tap **Drafts**.
2. Tap the message to resume editing it.
3. When you finish editing the message, tap **Send**.

New message notifications

Depending on your notification settings, the phone will play a ring tone, vibrate, or display the message briefly in the status bar when you receive a new text or multimedia message. To change the notification for new text and multimedia messages, see “Setting text and multimedia message options” later in this chapter.



A new message icon  also appears in the notifications area of the status bar to notify you of a new text or multimedia message. The **Messages** application icon (if shown on the Home screen) also displays the number of new messages .

To open the message, press and hold the status bar, and then slide the status bar down to open the Notifications panel. Tap the new message to open and read it. For information on reading and replying to messages see “Managing message conversations” in this chapter.

WAP push messages

WAP push messages contain a web link. Often, the link will be to download a file that you have requested, for example a ring tone.

When you receive a WAP push message, a notification icon  is displayed in the status bar.

Opening the link contained in a WAP push message

1. Press and hold the status bar, and then slide the status bar down to open the Notifications panel.
2. Tap the new message.
3. Tap Visit website.

Viewing all your WAP push messages

1. Press HOME, and then tap  > Messages.
2. Press MENU, and then tap Push messages.

Managing message conversations

Text and multimedia messages that are sent to and received from a contact (or a number) are grouped into conversations or message threads in the All messages screen. Threaded text or multimedia messages let you see exchanged messages (similar to a chat program) with a contact on the screen.

Reading a text message

Do one of the following:

- On the All messages screen, tap the text message or message thread to open and read it.
- If you have a new message notification, press and hold the status bar, and then slide the status bar down to open the Notifications panel. Tap the new message to open and read it.

To return to the All messages screen from a text message thread, press MENU and then tap **All messages**.



- To view the details of a particular message, in the message thread, press and hold the message to open the options menu, and then tap **View message details**.
- If a message contains a link to a web page, tap the message and then tap the link to open it in the web browser.
- If a message contains a phone number, tap the message and then tap the phone number to dial the number or add it to your contacts.

Viewing a multimedia message

1. Press HOME, and then tap  > Messages.
2. On the All messages screen, tap a multimedia message or message thread to open it.
3. Tap the attachment to open it.

If the attachment is a vCard contact, it is imported to your Phone contacts list. For information about contacts, see the People chapter.

If the attachment is a vCalendar file, you can choose the calendar where you want to save the event. For information on using Calendar, see the Calendar chapter.
4. To save the attachment to the storage card, press and hold the sender's name or number, and then tap **Save [attachment type]** on the options menu.



- When **Auto-retrieve** in MMS settings is disabled, only the message header is downloaded. To download the entire message, tap the **Download** button at the right side of the message. For details, see "Setting text and multimedia message options" later in this chapter.
- If you are concerned about the size of your data downloads, check the multimedia message size before you download it.

Replying to a text or multimedia message

1. Press HOME, and then tap  > Messages.
2. On the All messages screen, tap a text or multimedia message thread to open it.
3. Tap the text box at the bottom of the screen, enter your reply message, and then tap **Send**.



To reply to a text message with a multimedia message, open the text message, press MENU and then tap **More > Add subject**, or **Attach**. The text message is automatically converted into a multimedia message.

Protecting a message from deletion

You can lock a message so that it will not be deleted even if you delete the other messages in the conversation.

1. Press HOME, and then tap  > Messages.
2. On the All messages screen, tap a message thread.
3. Press and hold the message that you want to lock
4. Tap **Lock message** on the options menu.

A lock icon  is displayed at the right hand side of the message.

Deleting a message thread

1. Press HOME, and then tap  > Messages.
2. On the All messages screen, tap the message thread that you want to delete.
3. Press MENU, and then tap **Delete**.
4. When prompted to confirm, tap **OK**.



Any locked messages in the thread will not be deleted unless you select the **Delete locked messages** check box.

Deleting several message threads

1. Press HOME, and then tap  > Messages.
2. On the All messages screen, press MENU, and then tap **Delete**.
3. Select the message threads you want to delete.
4. Tap **Delete**. Any locked messages will not be deleted.

Deleting a single message

1. While viewing a message thread, press and hold the message that you want to delete.
2. If the message is locked, tap **Unlock message** on the options menu, and then press and hold the message to display the options menu again.
3. Tap **Delete message** on the options menu.
4. When prompted to confirm, tap **OK**.

Viewing contact details and communicating with a contact

When you have received a message from someone in your stored contacts, you can tap the contact's photo or icon in the message thread to open a menu of options. Depending on the stored contact information, you can view the contact details, phone or send an email message to the contact, and more.

Setting text and multimedia message options

Press HOME, and then tap  > Messages. On the All messages screen, press MENU and then tap **Settings** to set the text or multimedia message options. You can set the following:

SMS settings

Delivery reports

Select this option to receive a report on the delivery status of your message.

Service Center

Displays the message service center number used. Tap to change the number. It is recommended that you do not change the number here for it may cause problems in receiving and sending messages.

Manage SIM card messages

Tap to view text messages stored on your SIM card. You can also delete or copy these messages to your phone's memory.

MMS settings

Delivery reports

Select this option to receive a report on the delivery status of your message.

Read reports

Select this option if you want to receive a report whether each recipient has read or has deleted the message without reading it.

Auto-retrieve

Select this option to automatically retrieve all your MMS messages completely. When selected, the MMS message header plus the message body and attachments will automatically download to your phone. If you clear this check box, only the MMS message header will be retrieved and shown in your All messages screen.

Roaming auto-retrieve

Select this option to automatically retrieve all your MMS messages completely when roaming. This may incur significant phone charges.

Priority setting

Set the message priority of MMS messages sent.

Maximum message size

Set the maximum file size of an MMS message. The MMS message will not be sent out if it exceeds the file size set here.

Received messages

Received notification

Select this option if you want to receive a notification in the status bar when a new text or multimedia message arrives.

Play notification sound

If you want the phone to ring when a new message arrives, select this option.

Notification sound

Select a ring tone that is specific to new text and multimedia messages. Note that the ring tone briefly plays when selected.

Vibrate

Select this option if you want the phone to vibrate when a new text or multimedia message arrives.

Sent messages**Sent notification**

Select this option if you want to receive a notification in the status bar when a message is sent successfully.

Failure notification

Select this option if you want to receive a notification in the status bar when a message is not sent successfully.

Play notification sound

If you want the phone to ring when a sent or failure notification is received, select this option.

Notification sound

Select a ring tone that is specific to sent or failure notifications. Note that the ring tone briefly plays when selected.

Vibrate

Select this option if you want the phone to vibrate when a new text or multimedia message arrives.

Adding the Messages widget

Add the Messages widget to let you read your messages on the Home screen. To learn how to add widgets, refer to “Adding a widget to your Home screen” in the Personalizing chapter.

Accounts and sync

Synchronizing with online accounts

Your phone can sync information and receive updates from your Google™ and Microsoft® Exchange ActiveSync® accounts as well as popular online services such as Facebook®, Twitter™, and Flickr™.

These are some of the types of information you can sync:

- Gmail™/Google Mail and Exchange ActiveSync email.
- Google and Exchange ActiveSync contacts, as well as your Facebook friends' contact information. For information on contacts, see the People chapter.
- Calendar events from your primary Google Account and from Exchange ActiveSync. For information on using Calendar, see the Calendar chapter.
- Status updates and links shared by your friends and yourself on social networks such as Facebook and Twitter. For details, see the Social chapter.
- Flickr and Facebook photo uploads. For information on viewing photos, see the Photos chapter.

Adding a social network account

You can sync with your accounts on popular online services such as Facebook, Twitter, and Flickr.

1. Press HOME > MENU, and then tap **Settings > Accounts & sync**.
2. Tap **Add account**, and then tap the account type you want to add.
3. Follow the onscreen instructions to enter the account information.

When you have finished, the account is added to the list on the Accounts & sync screen. Depending on how you configured the account, the new information may start synchronizing with your phone.

Synchronizing with a Google Account

Signing in to your Google Account lets you synchronize Gmail/Google Mail and your Google contacts and calendars between your phone and the web. You also need to sign in to a Google Account to use Google applications such as Google Talk™ and Android Market.

You can add more than one Google Account on your phone. However, subsequent Google Accounts can only synchronize Gmail/Google Mail and contacts. Other Google services use the first Google Account you added.

1. Press HOME > MENU, and then tap **Settings > Accounts & sync**.
2. Tap **Add account > Google**.
3. Follow the onscreen instructions to sign in to an account or create a new account.

Synchronizing with a Microsoft Exchange ActiveSync account

You can only add one Microsoft Exchange ActiveSync account on your phone. You can sync with Microsoft Exchange Server 2003 Service Pack 2 (SP2) or later.

1. Press HOME > MENU, and then tap **Settings > Accounts & sync**.
2. Tap **Add account > Exchange ActiveSync**.
3. Enter the Exchange ActiveSync account details, and then tap **Next**.



Your corporate Exchange Server must support auto-detect for the phone to automatically set up the Exchange ActiveSync account. If your corporate Exchange Server does not support auto-detect, you will need to enter your Exchange Server settings after you tap **Next**. Ask your Exchange Server administrator for details.

4. Select the types of information you want to synchronize, and then tap **Finish setup**.

Managing your accounts

Changing general sync settings

1. Press HOME > MENU, and then tap **Settings > Accounts & sync**.
2. Select or clear the following:
 - **Background data**. If this is selected, applications can send and receive online account information even if you are not currently using them.
 - **Auto-sync**. If this is selected, applications can use the sync schedule defined in the account settings. If this is cleared, you will need to sync accounts manually. For instructions on doing this, see “Synchronizing an account manually” below.

Changing account settings

You can change settings such as the sync frequency and the types of information synchronized, the kinds of notification you receive, and the way that account information is displayed.

1. Press HOME > MENU, and then tap **Settings > Accounts & sync**.
2. Tap the account that you want to edit.
3. Edit the account settings.

Synchronizing an account manually

1. Press HOME > MENU, and then tap **Settings > Accounts & sync**.
2. Tap the account that you want to sync.
3. Tap **Sync now**.

Removing an account

You can remove an account to delete it and all information associated with it from your phone, for example messages, contacts, or settings. Removing an account does not delete information from the online service itself.



You cannot remove some accounts, such the first Google Account you signed into on the phone, except by deleting all personal information from your phone with a hard reset. For instructions on doing this, see “Performing a hard/factory reset” in the Backup, update and reset chapter.

1. Press HOME > MENU, and then tap **Settings > Accounts & sync**.
2. Tap the account that you want to remove.
3. Tap **Remove account**, and then confirm that you want to remove the account.

Using HTC Sync

Are you using Microsoft Outlook or Outlook Express on your computer? You can use **HTC Sync** to synchronize your Outlook contacts and calendar or your Outlook Express contacts with your phone. Before you do a factory reset or a software (ROM) upgrade of your phone, you can also use HTC Sync to back up and sync these information from your phone back to your computer.

Here's what you'll need to do to install, set up, and use HTC Sync on your computer:

1. You can download and install HTC Sync from the HTC support website. See "Downloading the latest HTC Sync upgrade" for details.
2. Connect your phone to your computer using the supplied USB cable and set up HTC Sync to recognize your phone. Follow the steps in "Setting Up HTC Sync to recognize your phone".
3. Choose what information to sync between your computer and your phone and how you want to sync them.
 - To easily set up synchronization using HTC Sync's guided wizard, follow the steps in "Setting up synchronization".
 - To choose from more sync options, see "Setting up more sync options".
4. Sync your computer with your phone automatically or manually. See "Synchronizing your phone" for details.

Here's more you can do with HTC Sync:

- If you have third-party applications on your computer (not from Android Market), you can use HTC Sync to install them from your computer to your phone. For more information, see "Installing apps from your computer to your phone".
- Repair contacts and/or calendar data, only if needed.

Installing HTC Sync from www.htc.com/ca/support

Download HTC Sync from www.htc.com/ca/support. On your computer, double-click HTCSync.exe and follow the onscreen instructions to install HTC Sync.

The HTC Sync version can be installed in Windows 7, Windows Vista and Windows XP Service Pack 2.



- HTC Sync requires USB 2.0 on your computer to connect and sync with your phone. To see a complete list of the computer and software requirements, you can check them in the HTC Sync software download page on the HTC support website: www.htc.com/ca/support
- For trouble-free installation, first quit all running programs and temporarily exit from your anti-virus program before you start installing HTC Sync.

Setting up HTC Sync to recognize your phone

After installing, set up HTC Sync to recognize your phone.

1. Connect your phone to the computer with the supplied USB cable. Or, if your phone is already connected, press and hold the status bar and drag your finger down to open the Notifications panel. Then tap the status that shows "Select to change USB connection type".

2. On the Connect to PC screen in your phone., tap **HTC Sync** and then tap **Done**.
3. Your phone attempts to find HTC Sync on your computer. Wait for a few seconds for the process to finish.



If your phone displays a message indicating that it's unable to find HTC Sync, try disconnecting and reconnecting the USB cable, and then repeat step 2.

4. When your phone finds HTC Sync, your computer will display the Phone Connection Wizard. Click **Next**.
5. Enter the name you want for your phone, and then click **Finish**.
6. Check the HTC Sync icon at the bottom-right side of your computer screen. If it appears green in color, that means your phone has successfully connected with your computer and HTC Sync recognizes your phone.



Setting up synchronization

You can set up HTC Sync to synchronize your computer's Outlook contacts and calendar events with your phone. If you're using Outlook Express on your computer, you can only sync contacts with your phone.



Before you begin setting up synchronization, make sure you have set up HTC Sync to recognize your phone. If you have not yet done so, follow the steps in "Setting up HTC Sync to recognize your phone".

1. On your computer, check and make sure the HTC Sync icon  at the bottom-right side of the screen appears in green which means that your phone is connected to HTC Sync.
2. Double-click the green HTC Sync icon on your computer to open HTC Sync.
3. Click **Synchronize Now**. (You can also click **Sync Manager > Settings**.)
4. In the Synchronization Settings Wizard, click **Next**.

5. In the next few dialog boxes, choose whether to sync Outlook or Outlook Express, select the type of information to sync (contacts and/or calendar), and choose to sync them automatically or manually with your phone.
6. Click **Finish**.
HTC Sync then starts to sync your phone and your computer. Wait for the synchronization to finish.
7. A summary report is then displayed. Click **Close**.

Setting up more sync options

HTC Sync gives you the flexibility to set many options, such as setting a sync schedule, choosing how to resolve conflicts when the same items are found on both the phone and the computer, and more.

1. On your computer, check and make sure the HTC Sync icon  at the bottom-right side of the screen appears in green which means that your phone is connected to HTC Sync.
2. If HTC Sync is not open, double-click the green HTC Sync icon to open it.
3. Click **Sync Manager > Settings**.
4. In the Synchronization Settings Wizard dialog box, click **Manual settings**.
5. From the left side of the Sync Manager Settings dialog box, click the type of setting you want to change, and then choose from the available options on the right. Settings that can be changed include the following:

Contacts or Calendar folder to sync with

Change this only if you have personal folders created in your Outlook and you need to sync with a personal folder. Click **Contacts** or **Calendar** on the left side of the dialog box, click the **Properties** button, and then choose the personal folder to sync with.

Calendar events to sync with

Choose the number of days of calendar events to sync. Click **Calendar** on the left side of the dialog box, click **Properties**, and then set the days under **Date range**.

Conflict policy

In cases when the same contacts and/or calendar items exist in both your phone and your computer, choose whose data you want to keep when a conflict occurs.

When to sync

Click **Automatic sync** on the left side of the dialog box. Then choose whether to sync manually, auto sync everytime you connect your phone to your computer, or sync at a set schedule.

6. Click **Apply** to save the sync options you've selected, and then click **OK**.

Synchronizing your phone

After you've installed and set up HTC Sync, you can sync your phone with your computer.

Synchronizing your phone with your computer automatically

Do the following first to make sure your phone will sync automatically with your computer:

1. Press HOME > MENU, and then tap **Settings > Applications > Development**.
2. Make sure the **USB debugging** check box is selected.

Whenever you connect your phone to your computer, synchronization starts automatically. Wait for the sync process to finish.

Synchronizing your phone with your computer manually

1. Connect your phone to the computer with the supplied USB cable. Or, if your phone is already connected, press and hold the status bar and drag your finger down to open the Notifications panel. Then tap the status that shows "Select to change USB connection type".
2. On the Connect to PC screen in your phone., tap **HTC Sync** and then tap **Done**.
3. On your computer, check and make sure that the HTC Sync icon  at the bottom-right side of the screen appears in green which means that your phone is connected to HTC Sync.
4. On your phone, tap **Sync now**.

Downloading the latest HTC Sync upgrade

Visit the HTC support website (www.htc.com/ca/support) from time to time to check for the most recent HTC Sync upgrade so you can download and install it on your computer.

After installing the latest upgrade, set up HTC Sync again to recognize and sync with your phone. Follow the steps in "Setting up HTC Sync to recognize your phone" and "Setting up synchronization".

Installing apps from your computer to your phone

If you have applications (.apk files) on your computer, you can use HTC Sync to install them to your phone. We strongly recommend you install only applications that you trust.

1. On your phone, press HOME > MENU, tap **Settings > Applications**, and then select the **Unknown sources** check box to allow applications from your computer to be installed to your phone.



You only have to do this step once. You do not need to do this step again next time you install another application from your computer to your phone.

2. Connect your phone to the computer with the supplied USB cable. Or, if your phone is already connected, press and hold the status bar and drag your finger down to open the Notifications panel. Then tap the status that shows "Select to change USB connection type".
3. On the Connect to PC screen in your phone., tap **HTC Sync** and then tap **Done**.
4. On your computer, double-click the green HTC Sync icon  to open HTC Sync.
5. In HTC Sync, click **Application Installer**.

6. In the Application Installer file types dialog box, make sure that the **Android OS installer file (apk)** check box is selected and then click **OK**.



This dialog box only appears the first time you use the Application Installer.

7. Click **Next**.
8. Click **Browse**, locate the application (.apk) on your computer, and then click **Open**.
9. After selecting the application, click **Next**.
10. Click **Finish**. Check your phone's screen to see if there are additional instructions to complete the installation.

Social

Facebook for HTC Sense

View your Facebook® updates in supported applications on the phone. By signing in to Facebook for HTC Sense, your Facebook contacts and their contact details are downloaded to People, you can browse through Facebook photo albums in Photos, and read Facebook status updates in Friend Stream. To learn how to sign in to Facebook for HTC Sense, see the Accounts and sync chapter.

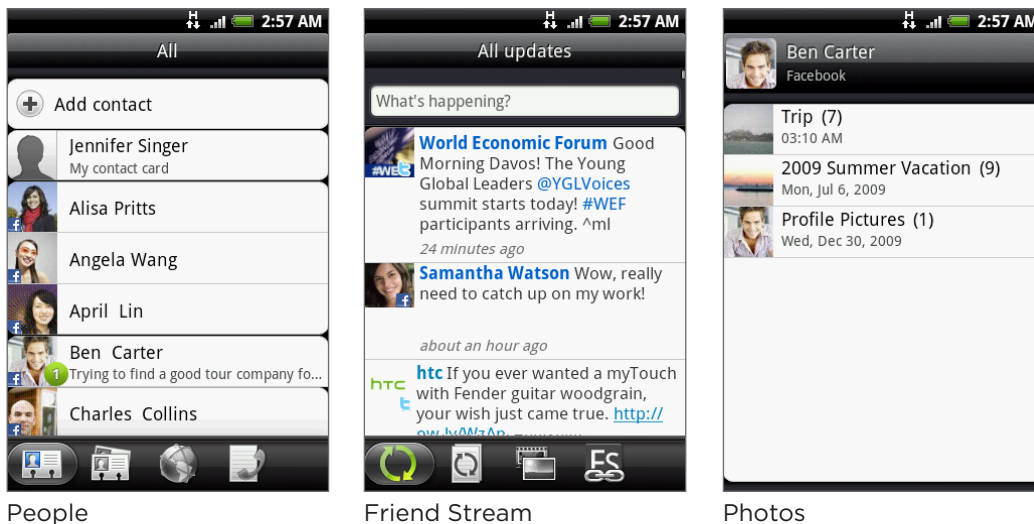

To learn about the Facebook application on the phone, see “Using the Facebook application” in this chapter.

Using the Facebook application

The Facebook® application on your phone lets you keep up and stay close with your friends in Facebook. It offers most of the features that you are familiar with when using Facebook on your computer.

1. Press HOME, and then tap  > Facebook.
2. If this is your first time to use Facebook, follow the onscreen instructions to sign into your Facebook account.
3. On the News Feed screen, press MENU, and then tap Home to access the other functions.



- While on the Facebook home screen, press MENU, and then tap Settings to set refresh and notification options.
- On some Facebook screens, you can press and hold an item to open an options menu.

With the Facebook application, you can:

- Share your thoughts and check other people's status updates.
- View your friends list and write on someone's wall.
- Comment on and like a friend's post.
- View someone's personal information, including photo albums.
- Check your Facebook notifications.
- Take a photo and upload it straight to your Facebook account.

Adding the Facebook widget

Add the Facebook widget to the Home screen to let you quickly share your thoughts and view your friends' status updates.

1. Press HOME, and then tap  > Widget > Facebook.
2. Choose the widget style, and then tap **Select**.
3. Drag the widget to a blank space on the Home screen, and then release.

Twittering on your phone

Peep is a Twitter™ client that lets you enjoy “twittering” on your phone. Send out tweets, read and receive tweets from people, search for new Twitter users to follow, all from your phone.

1. Press HOME, and then tap  > Peep.
2. If you did not sign in to your Twitter account when you first turned on the phone, follow the onscreen instructions to sign in to your Twitter account.
3. Peep opens in the **All Tweets** tab. Slide your finger on the bottom row to go to the tab you want.

Peep screen

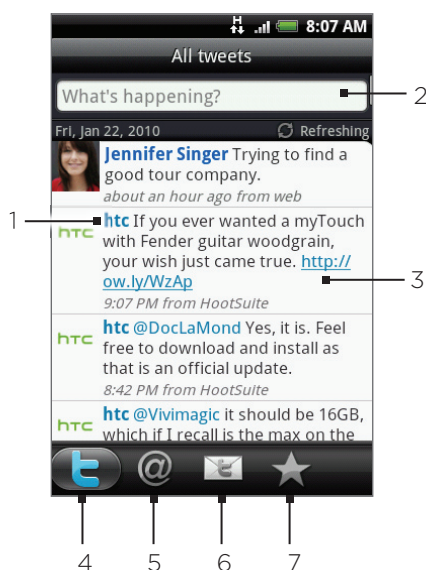



- | | |
|---|--|
| 1 | Tap to view the Twitter user's profile. This also shows you all tweets from this Twitter user. |
| 2 | Tap to enter a tweet to send out. |
| 3 | Press and hold to open the options menu to let you reply, send a direct message, retweet, add to favorite, and view the profile. |
| 4 | Shows all the tweets from people you follow and tweets that you have sent out. |
| 5 | Shows all tweets that mentions your username using the “@[your username]” convention. |
| 6 | Shows all private/direct messages that you have received or sent out. |
| 7 | Shows tweets that were marked as favorites. |

Sending a tweet

1. Press HOME, and then tap  > Peep.
2. On the **All Tweets** tab, tap the text field with the words “What’s happening?”.
3. Enter your tweet, and then tap **Update**. Before tapping **Update**, you can:
 - Tap  to post a picture from Photos or Camera to your default photo hosting site and add the link to the picture into the tweet.
 - Tap  to insert your location into the tweet. You can choose to add a map link, insert your location name, or insert your position coordinates.

Searching for Twitter users to follow

1. Press HOME, and then tap  > Peep.
2. While on the Peep screen, press the SEARCH button.
3. Tap the text field with the words “Search Twitter”, enter the search criteria, and then tap .
4. On the Search result screen, scroll through the list, and then tap the twitter user you want to follow.



The search results will also list down tweets that contain the search word.

5. Press MENU, and then tap Follow.

Unfollowing a Twitter user

1. Press HOME, and then tap  > Peep.
2. On the All Tweets tab, tap Twitter user you want to stop following.
3. Press MENU, and then tap Unfollow.

Sending a direct message

You can only send a direct message to someone who is following you.

1. Press HOME, and then tap  > Peep.
2. Press MENU, and then tap New message.



You can also send a direct message from the All Tweets or Direct Message tab. On the All Tweets or Direct Message tab, press and hold the person you want to send the direct message to, and then tap Send direct message on the options menu.

3. Tap the To field, and then enter the name. As you enter characters, the names of the Twitter users that match the characters you enter will appear. Tap the name when you see it.
4. Enter your message, and then tap Update.

Setting Peep options

1. Press HOME, and then tap  > Peep.
2. Press MENU, and then tap More > Settings. You can set these options:

Account settings

Sign out of your Twitter account.

General settings

Choose whether to show the screen name or the real name of the people you follow.

Send & receive

Set the frequency to check for new tweets and set the number of tweets to download.

Services

Set your photo hosting site, photo quality, location options, and URL shortening host.

Notification settings

Select when to be notified and how you want to be notified.

Adding the Twitter widget

Add the Twitter widget to let you send and follow your tweets right on the Home screen.

1. Press HOME, and then tap  > Widget > Twitter.
2. Choose the widget style, and then tap **Select**.
3. Drag the widget to a blank space on the Home screen, and then release.

Using Friend Stream

Streamline your social network accounts through Friend Stream. Update your status simultaneously, view status updates, and look through photo updates from your Facebook, Twitter, and other social network accounts using Friend Stream.

1. Press HOME, and then tap  > Friend Stream.
2. If you are not signed in to a social network account, you will be asked to sign in to at least one of the social network accounts.
3. Friend Stream opens in the All Updates tab. Slide your finger on the bottom row to go to the tab you want.

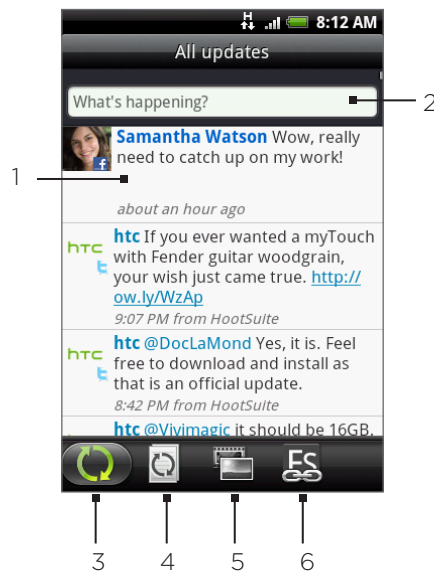

Friend Stream screen

Only updates from accounts that you are signed in to will be shown.



-
- 1 Depending on the type, tap to open Peep, post a Facebook comment, look at the Flickr album, or open the link in the web browser.
 - 2 Tap to enter and send a status update.
 - 3 Shows all the messages from the social network accounts that you are signed in to.
 - 4 Shows only status updates from Facebook and Twitter.
 - 5 Shows only photo updates from Facebook and Flickr.
 - 6 Shows only links posted on Facebook.
-

Updating your status

1. Press HOME, and then tap  > Friend Stream.
2. On the **All Updates** tab, tap the text field with the words “What’s happening?”.
3. Tap , and then on the Update Status dialog box, select which accounts you want the status update to be posted. Tap **Done**.



Only the accounts that you are signed in to will be shown on the dialog box.

4. Enter your status update, and then tap **Update**.

Adding the Friend Stream widget

Add the Friend Stream widget so you can update your status simultaneously and view status updates from your social network accounts right on the Home screen.

1. Press HOME, and then tap  > Widget > Friend Stream.
2. Choose the widget style, and then tap **Select**.
3. Drag the widget to a blank space on the Home screen, and then release.

Chatting in Google Talk

Google Talk is Google's instant messaging program. It lets you communicate with other people that also use Google Talk.

Signing in to Google Talk

If you signed in to your Google Account when you first set up the phone, you are already signed in to Google Talk.

1. Press HOME, and then tap  > Talk > Next > Sign in.
2. Enter your Google Account username and password, and then tap **Sign in**.

When you are signed in to Google Talk, your online status in Google Talk will also appear in other Google Apps such as Gmail/Google Mail and Google Maps.

Signing out of Google Talk

If you are not going to use Google Talk for an extended period of time, we recommend that you sign out of Google Talk to save battery power.

1. Press HOME, and then tap  > Talk.
2. In the Friends list, press MENU, and then tap **More > Sign out**.

Chatting with friends

Starting a chat

1. Press HOME, and then tap  > Talk.
2. Tap a friend in the Friends list.
3. Chat with your friend by entering text in the text box at the bottom of the screen.



To insert a smiley, press MENU, and then tap **More > Insert smiley**. Tap a smiley to insert it into your message.

4. After entering your message, tap **Send**.

Accepting an invitation to chat

When a friend sends you a Google Talk message, you receive a notification. Their entry in the Friends list turns white and displays the message.

Do one of the following:

- In the Friends list, tap the friend who sent you the invitation to chat.
- Open the Notifications panel, and then tap the chat notification. See “Opening the Notifications panel” in the Basic chapter to learn how to open the Notifications panel.

Returning to the Friends list

While on a chat screen, press MENU, and then tap **Friends list**.

Switching between active chats

You can switch between chats if you have more than one chat going.

1. While on a chat screen, press MENU, and then tap **Switch chats**.
2. On the screen that opens, tap the friend you want to chat with.

Inviting a friend to join a group chat

1. While on a chat screen, press MENU, and then tap **Add chat**.
2. Tap the friend you want to invite. The friend you invited and the current participants receive an invitation to a group chat. Each one who accepts the invitation joins the group chat.

Chatting on or off the record

Your Google Talk messages are stored, so you can review them later and even search for them in the Chats folder in Gmail/Google Mail. But, if you'd rather not store the messages in a chat, you can go off the record.

1. On a chat screen, press MENU, and then tap **Chat off record**.

To resume saving the messages in the chat, press MENU, and then tap **Chat on record**.



Ending a chat

Do one of the following:

- In the Friends list, press and hold the friend you want to stop chatting with, and then in the menu that opens, tap **End chat**.
- While on a chat screen, press MENU, and then tap **End chat**.

Changing your online status and picture



Changing your online status

1. Press HOME, and then tap  > Talk.
2. In the Friends list, tap the online status icon () beside your name, and then select the status you want on the options menu.

In addition to the standard status settings described in the table, you can also select a message that you've entered previously. Or tap **Clear custom messages** to erase them and start over.

Your status and any message appear in your contact's Friends lists and in other locations where your status or status message are displayed.

Changing your status message

1. Press HOME, and then tap  > Talk.
2. In the Friends list, tap the text box to the left of your online status icon, and then enter your status message.
3. On the onscreen keyboard, tap .

Changing your picture

1. Press HOME, and then tap  > Talk.
2. In the Friends list, tap the picture to the left of your status message.
3. In the Select an album screen, tap the album where the picture you want to use is located.
4. Tap the picture you want to use.
5. Drag the green box to select the portion of the picture to crop, and then tap **Save**.

Managing your Friends list

Adding a friend

You can invite anyone with a Google Account to become your friend in Google Talk, so you can chat with each other and view each others' online status.

1. Press HOME, and then tap  > Talk.
2. In the Friends list, press MENU and then tap **Add friend**.
3. Enter the Google Talk instant messaging ID or Google email address of the friend you want to add.

Accepting an invitation to become a friend

When a contact invites you to become a friend in Google Talk, you receive a notification in the Status bar and the invitation appears in your Friends list.

1. Press HOME, and then tap  > Talk.
2. In the Friends list, tap **Chat invitation**.
3. Do one of the following:
 - Tap **Accept** in the menu that opens to accept the invitation.
 - Tap **Cancel** if you don't want to chat with and share your Google Talk status with the sender.

Viewing the list of pending invitations to friends

1. Press HOME, and then tap  > Talk.
2. In the Friends list, press MENU, and then tap **Invites**. All the friends to whom you've extended invitations to become friends on Google Talk appear in the list until they accept or cancel your invitation.
3. Tap a pending invitation, and then tap **Accept** or **Decline**.

Viewing all friends or only those most popular with you

By default, only the friends that you frequently chat with — the most popular — are shown in the Friends list. But you can view all friends instead.

1. Press HOME, and then tap  > Talk.
2. In the Friends list, press MENU, and then tap **All friends**. To switch back to just the friends with whom you chat most frequently, tap **Most popular** in the menu.

Making a friend popular

1. Press HOME, and then tap  > Talk.
2. In the Friends list, press and hold a friend's name.



If you cannot see the friend, press MENU, and then tap **All friends**.

3. In the options menu, tap **Always show friend**.

Blocking a friend

You can block a friend from sending you messages. When blocked, your friend is also removed from your Friends list.

1. Press HOME, and then tap  > Talk.
2. In the Friends list, press and hold the friend's name you want to block.



If you cannot see the friend, press MENU, and then tap **All friends**.

3. In the options menu, tap **Always show friend**. Your friend is removed from your friends list and is added to the blocked friends list.





To unblock a friend, in the Friends list, press MENU and then tap **Blocked**. In the Blocked friends list, tap the name of the friend you want to unblock, and then tap **OK** when prompted.

Changing Google Talk settings

Setting notifications for new Google Talk messages

You can set the phone to play a sound, vibrate, or display a notification icon in the status bar each time you receive a new instant message.

1. Press HOME, and then tap  > Talk.
2. In the Friends list, press MENU and then tap **More > Settings**.
3. Select the **IM notifications** check box to receive a notification () in the status bar when a new instant message arrives.
4. Do of the following:
 - Tap **Select ringtone** to select the ring tone to use when a new instant message arrives. The ring tone briefly plays when selected. If you don't want a ring tone to play when you receive a new Google Talk message, select **Silent**.
 - Select the **Vibrate** check box to vibrate your phone when you receive a new Google Talk message.

Showing or hiding the mobile indicator to friends

You can check what type of device your friend is using to chat in Google Talk. In the friends list, check the image that appears to the right of your friend's name.

1. Press HOME, and then tap  > Talk.
2. In the Friends list, press MENU, and then tap **More > Settings**.
3. Select the **Mobile indicator** option.

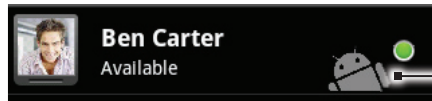

Indicates that the friend is using an Android phone.

Setting whether you sign into Google Talk automatically

You can sign in to your Google Talk account automatically every time you turn on your phone.

1. Press HOME, and then tap  > Talk.
2. In the Friends list, press MENU, and tap **More > Settings**.
3. Select the **Automatically sign in** check box.

Email

Using Gmail/Google Mail

Gmail/Google Mail is Google's web-based email service. Gmail/Google Mail is configured when you first set up your phone. Depending on your synchronization settings, Gmail/Google Mail on your phone is automatically synchronized with one or more Gmail/Google Mail accounts on the web. For more information about synchronization, see "Synchronizing with a Google Account" in the Accounts and sync chapter.

Viewing your Gmail/Google Mail inbox

The Inbox conversations list is your default Gmail/Google Mail view. All your received emails are delivered to your Inbox.

Gmail/Google Mail groups each message you send with all the responses you receive. This conversation list continues to grow as new replies arrive, so you can always see your messages in context. A new message or a change to the subject of a current message will begin a new conversation.

1. Press HOME, and then tap  > Gmail/Google Mail.
2. To scroll through the conversation list:
 - Slide your finger up/down on the screen.
 - Swipe up/down on the optical trackball.

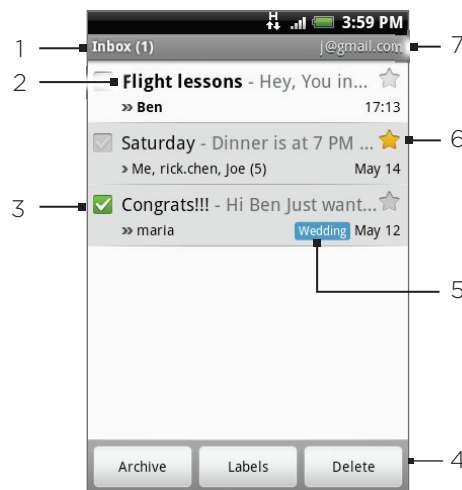

-
- 1 Folder (or Label) and number of unread email messages.
 - 2 Unread messages are displayed in bold.
 - 3 Checked email. Select one or more emails to apply an action.
Note: Batch operations needs to be enabled.
 - 4 Actions for checked email(s). This will not show if there is no item selected in the inbox.
 - 5 Message label.
 - 6 Starred message. Tap to add or remove the star.
 - 7 The Google Account you are currently viewing. To view another account, see "Switching to another Google Account" below.
-

Switching to another Google Account

If you have set up more than one Google Account on your phone, you can switch between accounts in Gmail/Google Mail. For more information on setting up Google Accounts, see “Synchronizing with a Google Account” in the Accounts and sync chapter.

1. While viewing the Inbox, press MENU, and then tap **Accounts**.
2. Tap the account to switch to.

Reading your messages

Depending on your notification settings, the phone plays a ring tone, vibrates, or displays the email message briefly in the status bar when you receive a new email. A new email message icon  also appears on the notifications area of the status bar to notify you of a new email. For more information on email notification settings, refer to “Changing Gmail/Google Mail settings” later in this chapter.

For information on automatic email synchronization, see “Changing Gmail/Google Mail synchronization settings” in this chapter.



To refresh your inbox manually, press MENU and then tap **Refresh**.

1. Do one of the following:
 - When you receive a new email notification, press and hold the status bar, and then slide down your finger on the screen to open the Notifications panel. Tap the new email to view it.
 - While in the Inbox, tap the unread email or the conversation with the unread email to view it.
2. To scroll through the messages in the conversation:
 - Slide your finger up/down on the screen.
 - Swipe up or down on the optical trackball.

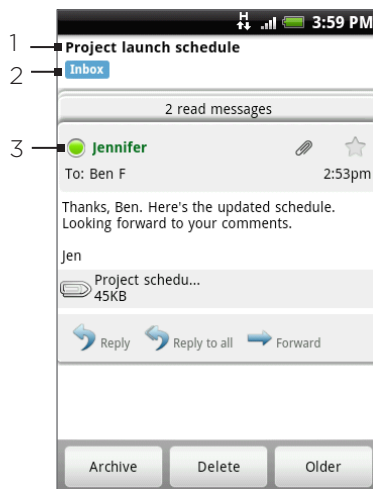

-
- 1 Message subject.
 - 2 Message label.
 - 3 Online status. Appears when the contact is a Google Talk friend and you are signed in to Google Talk.
-

3. To manage the email message or conversation, do any of the following:
 - Tap **Archive** to remove the conversation from your Inbox while still keeping it stored in your Google Account.



To display your archived messages, in the Inbox, press MENU and then tap **View labels > All Mail**.

- Tap **Delete** to delete the conversation from your Google Account. If you delete the conversation accidentally, you can tap **Undo** in the yellow bar at the top of the screen to undelete it.
- Tap **Older** to see the previous conversation in your Inbox.
- Press MENU to see more options.

Replying to or forwarding an email message

1. In the message thread, scroll down to the end of the conversation.
2. Tap **Reply**, **Reply to all**, or **Forward**.

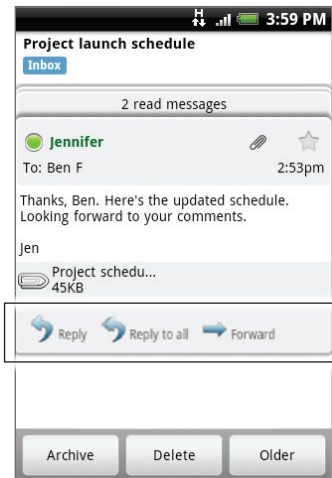

3. Do one of the following:
 - If you selected **Reply** or **Reply to all**, enter your reply message.
 - If you selected **Forward**, specify the message recipients.
4. Tap **Send**.

Muting a conversation

If you're part of a long message conversation that isn't relevant, you can 'mute' the conversation to keep all future additions out of your Inbox.

While viewing the message thread, press MENU and then tap **More > Mute**.

Reporting a conversation as spam

The Gmail/Google Mail webmail service works hard to prevent spam (unwanted and unsolicited "junk" mail) from reaching your Inbox. But when spam makes it through, you can help improve the service by reporting the conversation as spam.

While viewing the message thread, press MENU, and then tap **More > Report spam**.

Sending a message

1. Press HOME, and then tap  > Gmail/Google Mail.
2. In the Inbox, press MENU and then tap **Compose**.
3. Enter the message recipient's email address in the **To** field. If you are sending the email to several recipients, separate the email addresses with a comma. You can add as many message recipients as you want.
As you enter email addresses, any matching addresses from your contacts list are displayed. Tap a match to enter that address directly.

 If you want to send a carbon copy (Cc) or a blind carbon copy (Bcc) of the email to other recipients, press MENU and then tap **Add Cc/Bcc**.

4. Enter the email subject, and then compose your email.
5. If you want to add a picture attachment, press MENU and then tap **Attach**. Navigate to the picture you want to attach, and then tap the picture.



1	Recipient.
2	Subject.
3	Attachment.
4	Enter your message here.
5	Tap to remove the attachment.



5. After composing your message, tap **Send**.

 While composing the message, tap **Save as draft** or press the BACK button to save it as a draft. To view your draft email messages, in the Inbox, press MENU and then tap **View labels > Drafts**.

Adding a signature to your messages

You can add a signature to email messages that you send.

1. In the Inbox, press MENU and then tap **Settings > Signature**.
2. Enter your signature in the text box, and then tap **OK**.

 You can create a signature consisting of multiple lines of text. At the end of each line of text, tap  on the onscreen keyboard to create another line.

Viewing your sent messages

In the Inbox, press MENU and then tap **View labels > Sent**.

Managing conversations and messages

Searching for messages

You can search for messages that contain one or more words in their contents or in their addresses, subjects, labels, and so on. When you search for messages, all of the messages in your Gmail/Google Mail account on the web are included (except those labeled Trash or Spam), not just those that you've synchronized onto your phone.

1. In the Inbox, press SEARCH.
2. Enter the word or words to search for.
3. Tap , or tap the Enter key on the onscreen keyboard.

A conversation list opens, displaying all of the conversations with messages that contain the words you searched for. The words you searched for are displayed in the title bar. You work with the conversations in this list just as you would with the conversations in your Inbox or any other conversation list.

Starring a message

You can star an important message so that you can easily find it again. Conversations with starred messages are displayed with a star in your Inbox and other conversation lists. To view just conversations with starred messages, see “Viewing conversations by label” in this chapter.

Do one of the following:

- While reading a message, touch the star in its header.
- When viewing a conversation, touch its star to start the newest message in the conversation.

To unstar a message, touch its star again. You can also touch a star in a conversation list to unstar all messages in the conversation.

Labeling a conversation

You can organize conversations by labeling them. Gmail/Google Mail has several preset labels you can use, and you can also add your own labels, using Gmail/Google Mail on the web.

1. While viewing the messages in a conversation, press MENU and then touch **Change labels**.
2. Select the labels that you want to assign to the conversation, and then tap **OK**.

Viewing conversations by label

You can view a list of the conversations that have the same label.

1. When viewing your Inbox or another conversation list, press MENU, and then touch **View labels**.
2. Touch a label to view a list of conversations with that label.

The conversation list resembles your Inbox, but the label replaces “Inbox” in the title bar. You work with labeled conversations lists in the same way as with your Inbox.

Changing Gmail/Google Mail synchronization settings

1. Press HOME, and then tap  > Gmail/Google Mail.
2. Press MENU, and then tap **Settings** > **Labels**.
3. To set the number of days to synchronize, tap **Number of days to sync**.
4. To set synchronization for a particular label, tap the label. You can select to synchronize the default number of days, or you can sync all or none of the label's messages.

Working with conversations in batches

You can archive, label, delete, or perform other actions on a batch of conversations at once, in your Inbox or in another labeled list of conversations.

1. In the Inbox or other conversation list, select the check boxes for the conversations you want to work with as a batch. When you select a check box, the **Archive**, **Labels**, and **Delete** buttons are displayed at the bottom of the screen.

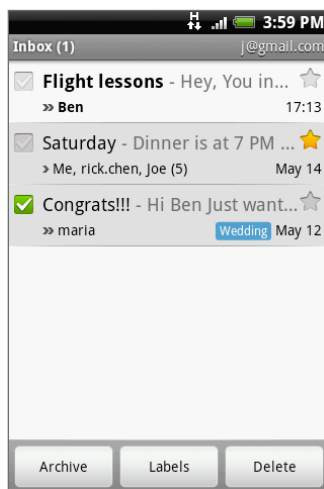

2. Tap the **Archive**, **Labels**, or **Delete** button to perform one of those actions on the batch of conversations, or press MENU for more options.

Changing Gmail/Google Mail settings

1. Press HOME, and then tap  > Gmail/Google Mail.
2. In the Inbox, press MENU and then tap **Settings**.
3. Set the following options:
 - **Signature.** Tap to enter a signature that is appended at the end of your emails.
 - **Confirm delete.** Select the check box to show a confirmation box when you delete a conversation.
 - **Batch operations.** When selected, this adds a check box to the left of each conversation so you can add it to a batch. See “Working with conversations in batches” above.
 - **Clear search history.** Remove the searches you have performed.
 - **Labels.** Tap to select how many days and which Gmail/Google Mail labels to synchronize.



- **Email notifications.** Select the check box to show a notification icon on the status bar when you receive a new email.
- Tap **Select ringtone** if you want your phone to play a notification sound when a new email message arrives. On the ring tone menu, select a ring tone specific to new email messages. The ring tone plays briefly when selected. If you don't want a ring tone to play when you receive a new email message, tap **Silent**. To confirm your ring tone selection, tap **OK**.
- Select **Vibrate** if you want your phone to vibrate when you receive a new email message.

Mail

The Mail application lets you send and receive email from your webmail or other accounts, using POP3 or IMAP.

It also lets you access your Exchange ActiveSync email and other features on your phone. For information on this, see “Exchange ActiveSync email” in this chapter.

Adding a POP3/IMAP email account

1. Press HOME, and then tap  > Mail.
2. Do one of the following:
 - If this is your first time to add an email account in Mail, tap **Other (POP3/IMAP)** on the **Choose a mail provider** screen.
 - If you have already added an email account in Mail, tap  on the upper-right corner, and then tap **New Account**. If the **Choose a mail provider** screen is displayed, tap **Other (POP3/IMAP)**.
3. Enter the **Email address** and **Password** for the email account and then tap **Next**.

If the account type you want to set up is not in the phone database, you will be asked to enter more details.

4. Enter the **Account name** and **Your name** and then tap **Finish setup**.

Viewing your email inbox

1. Press HOME, and then tap  > Mail.
2. Tap a tab at the bottom of the screen to filter the inbox.

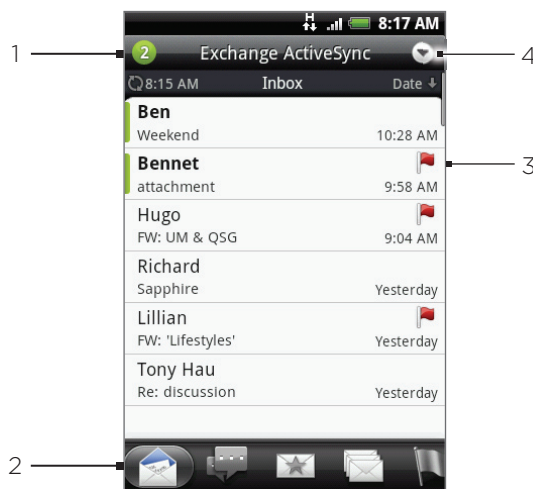

-
- 1 Number of unread email messages.
 - 2 Filter tabs. See “Inbox filter tabs” for details.
 - 3 Marked (Exchange ActiveSync only)
 - 4 Tap to view a different email account or add a new email account.
-

Inbox filter tabs



Received

Displays email messages as individual items.



Conversations

Displays messages as conversations, grouped according to the subject line. Tap a subject in the list to show the email conversation.



VIP group

Displays messages from contacts in your VIP group. To add contacts to the VIP group from this tab, tap **Add contact to group**, select the contacts you want to add, and then tap **Save**. For more information on contact groups, see “Contact groups” in the People chapter.



Unread

Displays unread messages.



Marked (Exchange ActiveSync only)

Displays all flagged messages.



Meeting invitations (Exchange ActiveSync only)

Displays meeting invitations which you have not yet accepted or declined.



Attachments

Displays all messages that have attachments.

Refreshing an email account

Whatever your automatic synchronization settings are, you can also synchronize your sent and received emails manually at any time.

While in the account you want to synchronize, press MENU, and then tap **Refresh**.

Sorting email messages

1. On the email account Inbox, press MENU, and then tap **Sort**.
2. Select from the options to sort email messages by date received, priority, subject, sender, or size.

Deleting an email message

1. On the email account Inbox, press and hold the message you want to delete.
2. On the options menu, tap **Delete**.

Deleting multiple email messages

1. On the email account Inbox, press MENU and then tap **Delete**.
2. Select the messages you want to delete, and then tap **Delete**.

Exchange ActiveSync email

If you synchronize your phone with your work Exchange ActiveSync account, you can read, manage, and send email in the same easy way as with a POP3/IMAP account. However, you can also access some powerful Exchange features.

For information on setting up an Exchange ActiveSync account, see “Synchronizing with a Microsoft Exchange ActiveSync account” in the Accounts and sync chapter.

Setting out of the office status

You can set your Out of Office status and auto-reply message right from your phone.

1. Press HOME, and then tap  > Mail.
2. Switch to the Exchange ActiveSync account.
3. Press MENU and then tap **More > Out of the office**.
4. Tap the field below **I am currently**, and then select **Out of the office**.
5. Set the dates and times for the period when you will be out of the office.
6. Enter the auto-reply message.
7. Tap **Save**.

Sending a meeting request

1. Press HOME, and then tap  > Mail.
2. Switch to the Exchange ActiveSync account.
3. Press MENU and then tap **More > New meeting invitation**.
4. Enter the meeting details, and then tap **Send**.



Setting the priority for an email message

You can set the priority for an email message you send with your Exchange ActiveSync account.

1. While composing the message, press MENU.
2. Tap **Priority**.
3. Select the priority for the message.

If you selected High or Low priority, the priority appears below the subject line of the message.

Composing and sending an email message

1. Press HOME, and then tap  > Mail.
2. On the email account Inbox, press MENU and then tap **Compose**.
3. Fill in one or more recipients. You can:
 - Enter email addresses directly in the To field. If you're sending the email to several recipients, separate the email addresses with a comma. As you enter email addresses, any matching addresses from your contacts list are displayed. Tap a match to enter that address directly.
 - Tap the  icon, and then select the contacts to whom you want to send the message. You can also select contact groups as recipients, or add contacts from the company directory if you have set up an Exchange ActiveSync account on your phone. When you have selected all the message recipients, tap **Done**.



If you want to send a carbon copy (Cc) or a blind carbon copy (Bcc) of the email to other recipients, press MENU, and then tap **Show Cc/Bcc**.



4. Enter the subject, and then compose your message.
5. To add an attachment, press MENU, tap **Add attachment**, and choose from the following options:
 - **Picture**. Select **Camera** to take a photo and attach it, or **Pictures** to attach a photo from your storage card.
 - **Video**. Select **Camcorder** to capture a video and attach it, or **Videos** to attach a video from your storage card.
 - **Audio**. Select **Voice Recorder** to make a voice recording and attach it, or **Music & sounds** to attach a music file or voice recording from your storage card.
 - **Location**. You can attach location information. Send your current location (requires GPS to be turned on), a location stored in Footprints, or a location you pick on a map. For more information about GPS, maps, and Footprints, see the Maps and location chapter.
 - **Document**. Attach a PDF file or an Office document such as a text file or a spreadsheet.
6. Tap **Send** to send the message immediately, or tap **Save as draft** if you want to send it later.



To open a draft email, in the email account Inbox, press MENU, and then tap **Folders > Drafts**.

Viewing and replying to an email message

1. Press HOME, and then tap  > Mail..
2. On the email account Inbox, tap the email you want to view.
3. Tap **Reply** or **Reply all** to reply to the email.

For an Exchange ActiveSync account, you can mark an email. To mark an email, while viewing an email, tap the white flag  on the upper-right corner of the screen. The flag turns red  when you mark the message.



You can copy, look up, translate, or share text from an email message. For information on how to do this, see “Copying text, looking up information, and sharing” in the Internet chapter.

Editing email account settings

1. Press HOME, and then tap  > Mail.
2. Switch to the email account you want to edit.
3. Press MENU and then tap **More > Settings**.
4. Select from the following settings:

Account settings

Change the email account settings such as the name, email address, password, and description.

General settings

Set the font size when reading emails, enable, disable or set the signature, set the account as the default email account, and set where to save email attachments.

Send & receive

Set the maximum email file size limit when receiving and frequency to check for new emails and how many to check for. You can also set to have emails that you send bcc'd to yourself.

Notification settings

Set email notification settings.

Delete account

Tap to delete the email account.

5. Press BACK to save your changes.

Deleting an email account

1. Press HOME, and then tap  > Mail.
2. Switch to the email account you want to delete.
3. Press MENU, and then tap **More > Settings > Delete account**.

Adding the Mail widget

Add the Mail widget to let you view your POP3/IMAP or Exchange ActiveSync emails on the Home screen. To learn how to add widgets, refer to “Adding a widget to your Home screen” in the Personalizing chapter.

Calendar

About Calendar

Use your phone's **Calendar** to create and manage your events, meetings, and appointments. You can also set up your phone to stay in sync with the following types of calendars:

- On your phone, sign in to your Google Account so you'll be able to sync your phone's Calendar with your Google Calendar online. If you have not signed in to your Google Account yet, see the Accounts and sync chapter to find out how to sign in.



You can create multiple Google Calendars only in Google Calendar on the Web. After creating them in Google Calendar on the Web, you'll be able to see them in the Calendar application on your phone.

For more information about creating and managing multiple Google Calendars, visit the Google website at the following URL: <http://calendar.google.com>.

- If you're using Microsoft Outlook on your computer, you can set up HTC Sync on your computer to sync Outlook Calendar with your phone's Calendar. See "Using HTC Sync" for details.
- If you have a Microsoft Exchange ActiveSync account and you have added it on your phone, you can sync your phone's Calendar with your Exchange ActiveSync calendar events. See the Email and Accounts and sync chapters for details.

Creating a calendar event

You can create events that appear on your phone only, as well as events that sync with your Google Calendar, your computer's Outlook Calendar, or Exchange ActiveSync calendar.

1. Press HOME, then tap , and then tap **Calendar**.
2. On any Calendar view, press MENU and then tap **New event**.



When you are in the Month or Agenda view, you can also tap  at the bottom-right of the screen to create a new event.

3. If you have more than one calendar, select a calendar in which to add the event:
 - Select **My Calendar** to create an event that will appear only on your phone.
 - Select your Google Account to create a Google Calendar event. If you have several Google Calendars on the Web, select one in which to add your event.
 - Select **PC Sync** to create an Outlook Calendar event to sync with your computer.
 - Select **Exchange** to create an Exchange ActiveSync calendar event.
4. Enter a name for the event.
5. To specify the date and time of the event, do one of the following:
 - If there is a time frame for the event, tap the **From** and **To** date and time to set them.
 - If it is a special occasion such as a birthday or a whole-day event, set the **From** and **To** date, then select the **All day** check box.
6. Enter the event location and description.

7. Set the reminder time.



You can add another reminder time in a Google Calendar event. Press MENU and then tap **Add reminder**.

8. If the event occurs on a regular basis, tap the **Repetition** box and then choose how often the event occurs.
9. Scroll to the bottom of the screen and then tap **Add**.

Inviting guests to your event (Google Account only)

If you want to invite guests to your event, you need to create and add the event in your Google Calendar. An invitation email will be sent to your guests using your Google Account.

1. Open Calendar and create a new event. Tap the **Calendar** field and then select your Google Account (or one of your other Google Calendars). For the steps, see “Creating a calendar event”.
2. Add details about the event, such as date and time, location, and more.
3. In the **Guests** field, enter the email addresses of everyone you want to invite to the event. Separate multiple addresses with commas (,).

If the people to whom you send invitations use Google Calendar, they’ll receive an invitation in Calendar and by email.

4. Tap **Add** to add the event to your Google Calendar.

Sending a meeting request using Calendar (Exchange ActiveSync only)

If you have an Exchange ActiveSync account set up on your phone, you can use Calendar to create a meeting appointment and send a meeting request email to the people you want to invite to your meeting.

1. Open Calendar and create a new event. Tap the **Calendar** field and then select **Exchange**. For the steps, see “Creating a calendar event”.
2. Add details about the meeting, such as date and time, location, and more.
3. Press MENU and then tap **Meeting Invitation**.
4. Tap  and choose attendees from your contacts or Company Directory.
5. Enter your message and then tap **Send**.
6. Tap **Add** to add the meeting appointment to your Exchange ActiveSync Calendar.

Changing calendar views



When you open Calendar, it displays the Month view by default. You can also display the Calendar in Agenda, Day, or Week view. To change between calendar views, press MENU, and then choose the type of view that you want.

Month view

In Month view, you'll see markers on days that have events.



When in Month view:

- Tap  on the bottom left of the screen to switch to Agenda view. Tap  on the bottom right to create a new event.
- Tap a day to view the events of that day.
- Press and hold a day to open an options menu from which you can also choose to create an event or switch to either Day or Agenda view.
- Slide your finger up or down the screen to view earlier or later months.

Day and Agenda views

Day view displays a list of the events of one day and also shows weather information at the bottom of the screen when you're viewing events of the current day. Agenda view shows a list of all your events in chronological order.

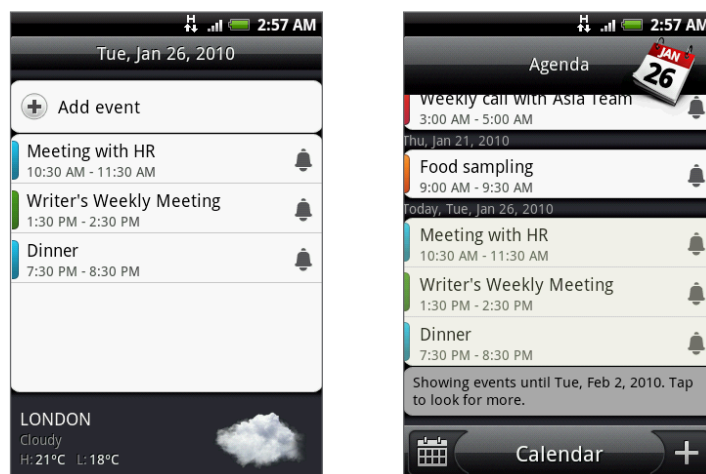

The color bars on the left side of the events indicate the type of calendar in which the event is part of. To find out what each color represents, press MENU and then tap **More > Calendars**.

When in Day view, slide left or right across the screen to view earlier or later days.



- In Day view, the weather information appears only if the event is within the five-day forecast of the Weather application.
- Weather information does not appear in Day view when you change Day view to display as a time list. See “Changing Calendar settings” for details.

Week view

Week view displays a chart of the events of one week.

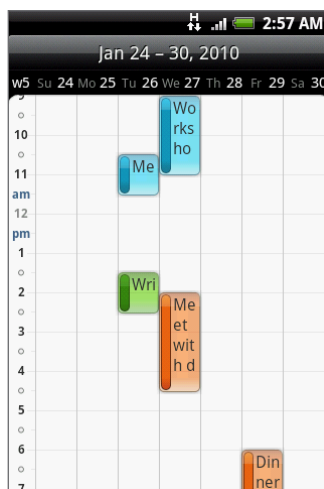

When in Week view:

- You can press and hold on a time slot to create a new event at that time.
- Tap an event to view its details.
- Slide left or right across the screen to view earlier or later weeks.



In a crowded Week view, it may be easier to select an event by using the optical trackball. Then press the optical trackball to view details about the selected event.

Viewing, editing or deleting an event

You can view, edit, or delete events you created. You can also view event invitations that other people sent to you.

Viewing and editing an event

1. Press HOME, then tap , and then tap **Calendar**.
2. In Month view, tap the day when the event takes place, and then tap the event to open it. The Event details screen then opens and shows the summary of the event.
3. When viewing the event summary, you can do the following:
 - Find the event's location in Maps.
 - If it's a Google Calendar or Exchange ActiveSync calendar event, check the participants of the event.
 - Change the reminder time.
 - If it's a Google Calendar event, respond whether you'll attend the event.
 - Press the BACK button on your phone to save changes you made on the Event details screen.
4. To edit more details about the event, press MENU while you're on the Event details screen and then tap **Edit event**.
5. Make your changes to the event.
6. When you're done editing, scroll down to the bottom of the screen and then tap **Save**.

Deleting an event

There are a number of ways to delete an event.

- While viewing the summary of an event on the Event details screen, press MENU and then tap **Delete event**.
- In Day, Agenda or Week view, press and hold an event and then tap **Delete event**.
- When editing an event, scroll down to the bottom of screen and then tap **Delete**.

If the event repeats, you'll be asked whether you want to delete just that occurrence, this and all future occurrences, or all past and future occurrences in your Calendar.

Calendar event reminders

If you have set at least one reminder for an event, the upcoming event icon  will appear in the notifications area of the status bar to remind you of the upcoming event.

Viewing, dismissing, or snoozing event reminders

1. Tap the status bar, then slide your finger down the screen to open the Notifications panel.
2. Do one of the following:
 - Tap **Clear** to dismiss event reminders and all other notifications. Other types of notifications such as new messages and missed calls will also be deleted.
 - After sliding open the Notifications panel, tap the calendar event reminder. You'll then see a list of all pending event reminders. Tap **Snooze all** to snooze all event reminders for five minutes, or tap **Dismiss all** to dismiss all event reminders.
 - Press **BACK** to keep the reminders pending in the notifications area of the status bar.

Displaying and synchronizing calendars

You can select which calendars to show or hide on your phone's Calendar, and which ones to keep synchronized.

Showing or hiding calendars

In any Calendar view, press MENU , tap **More > Calendars**, and then select or clear a calendar to show or hide it. Tap **All calendars** to display all calendars.

The calendars are kept synchronized on your phone, whether or not you hide them.

Choosing which Google Calendars are synchronized on your phone

You can choose which Google Calendars to keep synchronized on your phone or which ones to stop synchronizing.

Stop synchronizing a Google Calendar

1. In any Calendar view, press MENU and then tap **More > Calendars**.
2. Press MENU again and then tap **Remove calendars**.
3. Select a Google Calendar to remove from your calendars list, and then tap **OK**.
4. Press **BACK** to update Calendar with the new changes and return to the Calendar view you were viewing.

The calendars that you remove from your calendars list will no longer be synchronized on your phone, but you remain subscribed to them and can work with them in Google Calendar on the Web.

Adding a Google Calendar to sync with

Only the calendars that you've created or subscribed to on the Web, but previously removed from your calendars list, are shown in the list of calendars that you can add.

1. In any Calendar view, press MENU and then tap **More > Calendars**.
2. Press MENU again and then tap **Add calendars**.
3. Select a Google Calendar to add to your calendars list, and then tap **OK**.
4. Press **BACK** to update Calendar with the new changes and return to the Calendar view you were viewing.

Changing Calendar settings

You can change Calendar's settings to specify how it displays events and how it notifies you of upcoming events. In any Calendar view, press MENU and then tap **More > Settings** to access Calendar's settings.

Reminder settings

Choose how you want Calendar to issue event reminders when there are upcoming events.

All calendars

Select this check box to use the same event reminder settings for all types of calendars. If you clear this check box, you can set different reminder settings for each calendar.

Set alerts & notifications

Configure event reminders to open an alert, send you a notification, or turn off event notifications on your phone.

Default reminder time

Choose how soon before an event you want to be notified.

Select ringtone

Choose a ringtone to sound when you receive an event reminder.

Vibrate

Choose whether you want your phone to vibrate when you receive an event notification.

Hide declined events

Choose whether to show or hide events to which you've declined invitations.

Calendar view settings

Choose what appears in Calendar when opened and what's shown in Day, Week, and Month views.

Start in

Choose the default Calendar view that is displayed when you open Calendar.

Day views

Choose whether to display Day view in the form of an event list or time list.

First day of week

Set the Month and Week views to start on a Sunday or Monday.

Include weather

Make sure this check box is selected so that weather information is shown in Day view's event list.

City

By default, Day view displays your current location's weather. You can change it to display the weather of another city.

Sending a vCalendar

You can send a calendar event as a vCalendar to someone's phone or your computer using Bluetooth. You can also send it as a file attachment with your message.

1. Press HOME, tap , and then tap **Calendar**.
2. In Month view, tap the day when the event takes place.
3. Press and hold the calendar event you want to send, and then tap **Share vCalendar**.
4. Choose whether to send the event using Bluetooth or send it by email.
5. If you chose to send using Bluetooth, in the next few steps, you'll be asked to turn on Bluetooth on your phone and connect to the receiving Bluetooth device so the vCalendar can be sent. Follow the steps in "Sending information from your phone to another device" in the Bluetooth chapter.

If you chose to send by email, a new message window opens and automatically includes the vCalendar as an attachment. Your default email account that's selected in the Mail application will be used to send. For more information about using the Mail application, see the Email chapter.



You can also choose to send the vCalendar in a multimedia message. For more information about sending a multimedia message, see the Messages chapter.

About the Calendar widget

There's a **Calendar** widget available that you can add to your Home screen, and it comes in different calendar views. Tapping a day or event on the widget brings you to the Calendar application.

To find out how you can add a widget, see "Personalizing your Home screen with widgets" in the Personalizing chapter.

Clock and Weather

About the HTC Clock widget

The HTC Clock widget that's by default added on the Home screen shows your current date, time, and location. You can tap the weather image on this widget to open the Weather application and check for more weather forecasts. See “Checking weather” for details.



The HTC Clock widget comes in a variety of looks and designs. You can add another clock widget to the extended Home screen, if you want to have another clock that shows the time of another city. To find out how you can add a widget, see the Personalizing chapter.

About the Clock application

The **Clock** application is more than just a regular date and time clock. It functions as a desk clock that shows the date, time, and weather information, and it can turn into a night clock or screensaver. It has a world clock that shows you the current time in several locations across the globe. There's also an alarm clock, stopwatch, and countdown timer.

To open the Clock application:

- Press HOME and then tap the HTC Clock widget on the Home screen.
- You can also press HOME, tap , and then tap **Clock**.

Tap the tabs at the bottom row or slide your finger across the tabs to switch between the different functions of the Clock application.



1 Desk Clock tab

2 World Clock tab

3 Alarm Clock tab

4 Stopwatch tab

5 Timer tab

Using Desk Clock

Opening the Clock application brings you directly to the Desk Clock screen.

The Desk Clock displays the current date, time, and weather, an alarm clock indicator, and a battery charging indicator. You can dim the screen to show only the time and date on the Desk Clock.



- 1 The alarm clock indicator shows whether the alarm clock is on or off. To find out how to turn on and set the alarm clock, see “Setting the alarm clock”.
- 2 Below the date and time, you’ll see the weather information of your current location. Tapping the weather information brings you to the Weather application where you can see weather forecasts of the next few days. See “Checking weather” for more information about the Weather application.
- 3 The battery charging indicator shows the battery charge level. You’ll see it only when your phone is plugged with the power adapter or connected to your computer.
- 4 Tap this button to dim the screen and display only the time and date on the Desk Clock. To light up the screen again, tap anywhere on the screen or press the BACK button on your phone.
- 5 Tap this button to dim the screen and go into screensaver mode. When in screensaver mode, the time and date will change position on the screen after every few minutes. To light up the screen again, tap anywhere on the screen or press the BACK button on your phone.

You can change the Desk Clock screen to display the date and time of another time zone. To find out how to select a different time zone, see “Setting the time zone, date, and time”.

Using World Clock

Use the Clock application's World Clock screen to check the current time in several places around the globe simultaneously. You can also set your home city, add more cities to the world clock list, and manually set your time zone, date, and time.

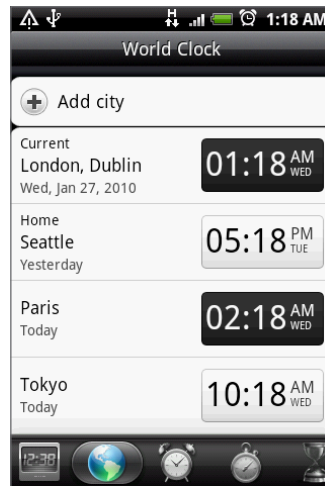

Setting your home city

1. Press HOME and then tap the HTC Clock widget on the Home screen.
2. Tap the World Clock tab.
3. Press MENU and then tap Home settings.
4. Enter your home city's name. As you enter letters, the list is filtered to show matching cities and countries.
5. Scroll through the list and tap your home city.

Setting the time zone, date, and time

To set the time zone, date, and time on your phone manually, you need to turn off auto time synchronization first.

1. Press HOME and then tap the HTC Clock widget on the Home screen.
2. Tap the World Clock tab.
3. Press MENU and then tap Local time settings to open the Date & time settings screen.
4. Clear the Automatic check box.
5. Tap Select time zone. Scroll through the list and then tap the time zone that you want.
6. To change the date, tap Set date. Adjust the date by rolling the day, month, and year scroll wheels onscreen and then tap Done.
7. To change the time, tap Set time. Adjust the time by rolling the hour and minute scroll wheels onscreen and then tap Done.
8. Tap the Use 24-hour format check box to toggle between using a 12-hour or a 24-hour time format.

9. Tap **Select date format** then select how you want dates to be displayed. (The selected date format also applies to the date displayed in the alarm clock.)



You can also press HOME > MENU and then tap **Settings > Date & time** to open the Date & time settings screen.

Adding a city to the World Clock screen

Add more cities to the World Clock screen so you can instantly check the date and time in these cities. In addition to the current and home cities, the World Clock screen can display up to 15 cities.

1. Press HOME and then tap the HTC Clock widget on the Home screen.
2. Tap the **World Clock** tab.
3. Tap **Add city**. Enter the city name you want to add. As you enter letters, the list is filtered to show matching cities and countries.
4. Scroll through the matching list and tap the city that you want to add.

Setting the alarm clock

You can use the Clock application's Alarms screen to set up one or more wake-up alarms.

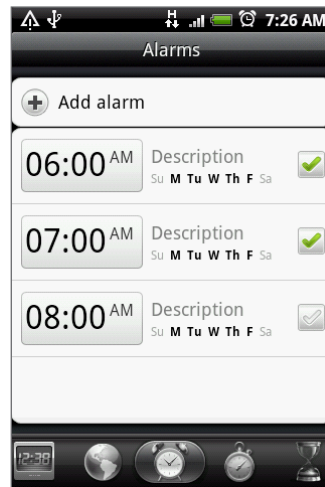

Setting an alarm

1. Press HOME and then tap the HTC Clock widget on the Home screen.
2. Tap the Alarms tab.
3. Select the check box of an alarm, and then tap that alarm.
4. On the Set alarm screen, drag your finger up or down to roll the time scroll wheels and set the alarm time.
5. Scroll through the Set alarms screen to see all the available alarm options. You can:
 - Enter the alarm **Description** and choose the **Alarm sound** to use.
 - Tap **Repeat**. Select what days of the week to sound the alarm and then tap **OK**.
 - Select the **Vibrate** check box if you want your phone to also vibrate when the alarm goes off.
6. When you've finished setting the alarm, tap **Done**.



- To turn off an alarm, clear the check box (by tapping it) of that alarm.
- If you need to set more than three alarms, press MENU while you're on the Alarms screen and then tap **Add alarm**.

Deleting an alarm

1. Press HOME and then tap the HTC Clock widget on the Home screen.
2. Tap the Alarms tab.
3. On the Alarms screen, press MENU and then tap **Delete**.
4. Select the alarms you want to delete and then tap **Delete**.

Changing alarm sound settings

If you've set one or more alarms, you can change their settings such as the alarm volume, how long to snooze the alarm, and more.

1. Press HOME and then tap the HTC Clock widget on the Home screen.
2. Tap the **Alarms** tab.
3. On the **Alarms** screen, press MENU and then tap **Settings**. You can change the following settings:

Alarm in silent mode

This option is selected by default, which allows the alarm to sound even when your phone's volume is set to silent mode. Clear this check box if you want to silence the alarm when the volume is in silent mode.

Alarm volume

Set the volume level that you want for the alarm.

Snooze duration

Set how long to snooze between alarms.

Side button behavior

Choose what happens to the alarm when pressing the side button (VOLUME UP/DOWN) of your phone. You can set the button to snooze, dismiss the alarm, or disable the button.

The side button works only when the phone's screen is not locked. While on the lock screen, tap the onscreen **Snooze** button to snooze, or slide down the screen to dismiss the alarm.

Checking weather

If you consented to turn location service on when you were setting up your phone for the first time, you'll see the weather of your current location right on the HTC Clock widget of your Home screen.

You can also use the Weather application to check the current weather and weather forecasts for the next four days of the week. In addition to your current location's weather, this application also displays the weather forecasts of other cities around the globe.



If you declined to turn location service on during first-time setup of your phone, turn location service on in your phone's settings so that you'll be able to check your current location's weather on the HTC Clock widget, Weather application, and the Weather widget. Press HOME > MENU, tap **Settings** > **Location**, and then select the **Use wireless networks** check box.



1. Connect to the Internet using your phone's Wi-Fi or data connection. To find out how, see the Internet chapter.
2. Press HOME, tap , and then tap **Weather**.
3. On the Weather screen, you'll first see your current location's weather. To check the weather in other cities, swipe your finger up or down the screen.





4. The Weather application automatically downloads and displays the latest weather updates. You can also download the most recent weather anytime by tapping .
5. To see more weather details on the Web, tap **Weather** at the bottom center of the Weather screen.

Adding a city to the Weather screen

Add more cities to the Weather screen so you can instantly check the weather forecasts in these cities. In addition to your current location, the Weather screen can display up to 15 cities.

1. Press HOME, tap , and then tap **Weather**.
2. On the Weather screen, tap .
3. Enter the location you want to add on the text field. As you enter text, the list is filtered to show the possible locations based on the letters you entered.
4. Tap the desired city to select it.

Changing the order of cities on the Weather screen

1. Press HOME, tap , and then tap **Weather**.
2. On the Weather screen, press MENU and then tap **Rearrange**.
3. Press and hold  at the end of the item you want to move. When the row is highlighted in green, drag it to its new position, then release.
4. Tap **Done**.

Deleting cities from the Weather screen

1. Press HOME, tap , and then tap **Weather**.
2. On the **Weather** screen, press MENU and then tap **Delete**.
3. Select the cities you want to remove and then tap **Delete**.

Changing weather options

1. Press HOME, tap , and then tap **Weather**.
2. On the **Weather** screen, press MENU and then tap **Settings**.
3. You can change the following weather settings:
 - Select or clear the **Update automatically** check box, depending on whether you want your phone to automatically download weather updates.
 - To set an auto update schedule, tap **Update frequency** and choose a schedule.
 - Tap **Temperature scale** to choose whether to display weather in Celsius or Fahrenheit.

About the Weather widget

Use the **Weather** widget to instantly check weather forecasts of your current location and other cities without having to open the Weather application.

The Weather widget comes in different looks and styles. You can add this widget to the Home screen, if it's not yet added. To find out how you can add a widget, see "Adding a widget to your Home screen" in the Personalizing chapter.

Internet

Data connection

Your phone will be automatically configured to use your mobile operator's data connection when you turn on your phone (if the SIM card is inserted) for the first time.

Checking the data connection you are using

1. Press HOME > MENU and then tap **Settings > Wireless & networks**.
2. Tap **Mobile networks > Network operators** or **Access Point Names**.

Turning the data connection on or off

Turning your data connection off can help optimize your battery life. It can also save money on data charges. However, when your data connection is turned off, you may not always receive automatic updates to your email, social network accounts, and other synchronized information.

1. Press HOME > MENU and then tap **Settings > Wireless & networks**.
2. Select the **Mobile network** check box to turn on the data connection; clear the check box to turn off the data connection.

Creating a new access point

When you need to add another data connection on your phone, obtain the access point name and settings (including username and password if required) from your mobile operator.

1. Press HOME > MENU and then tap **Settings > Wireless & networks**.
2. Tap **Mobile networks > Access Point Names**.
3. On the APNs screen, press MENU and then tap **New APN**.
4. In the Edit access point screen, enter the APN settings. Tap the APN setting item to edit it.
5. Press MENU and then tap **Save** when you finish setting up the new APN.

Enabling data roaming

Data roaming lets you connect to your mobile operator's partner networks and access data services when you are out of your mobile operator's coverage area.

1. Press HOME > MENU and then tap **Settings > Wireless & networks**.
2. Tap **Mobile networks** and then select the **Data roaming** check box.



Accessing data services while roaming may incur significant charges. Inquire about the data roaming tariffs with your mobile operator before enabling data roaming.

Wi-Fi



Wi-Fi provides wireless Internet access over distances of up to 300 feet (100 meters). To use Wi-Fi on your phone, you need access to a wireless access point or “hotspot”.



The availability and range of the Wi-Fi signal depends on the number, infrastructure, and other objects through which the signal passes.

Turning Wi-Fi on and connecting to a wireless network

1. Press HOME > MENU, and then tap **Settings > Wireless controls**.
2. Select the **Wi-Fi** check box to turn Wi-Fi on. The phone will scan for available wireless networks.
3. Tap **Wi-Fi settings**. The network names and security settings of detected Wi-Fi networks are displayed in the Wi-Fi networks section.
4. Tap a Wi-Fi network to connect. If you selected an open network, you will be automatically connected to the network. If you selected a network that is secured with WEP, enter the key and then tap **Connect**.
Depending on the network type and its security settings, you may also need to enter more information or choose a security certificate.

When your phone is connected to a wireless network, the Wi-Fi icon  appears in the status bar and tells you the approximate signal strength (number of bands that light up). If **Network notification** in Wi-Fi settings is enabled, this icon  appears in the status bar whenever the phone detects an available wireless network within range.



The next time your phone connects to a previously accessed secured wireless network, you will not be prompted to enter the key or other security information again, unless you reset your phone to its factory default settings.

Connecting to a Wi-Fi network with EAP-TLS security

You may need to install a network certificate (.p12) to your phone before you can connect to a Wi-Fi network with EAP-TLS authentication protocol.

1. Save the certificate file to the root folder of the storage card.
2. Press HOME > MENU, and then tap **Settings > Security**.
3. Tap **Install from SD card**.
4. Select the network certificate needed to connect to the EAP-TLS network.
5. Follow the steps in the previous section to connect to the Wi-Fi network.

Checking the wireless network status

1. Press HOME > MENU and then tap **Settings > Wireless & networks**.
2. On the Wireless & networks screen, tap **Wi-Fi settings**, and then tap the wireless network that the phone is currently connected to.

A message box is then displayed showing the Wi-Fi network name, status, speed, signal strength, and more.



 If you want to remove the wireless network settings on your phone, tap **Forget** on this window. You need to enter the settings again if you want to connect to this wireless network.

Connecting to another Wi-Fi network

1. On the Wireless controls screen, tap **Wi-Fi settings**. Detected Wi-Fi networks are displayed in the Wi-Fi networks section. To manually scan for available Wi-Fi networks, on the Wi-Fi settings screen, press MENU and then tap **Scan**.
2. Tap another Wi-Fi network to connect to it.

 If the wireless network you want to connect to is not in the list of detected networks, scroll down the screen, then tap **Add Wi-Fi network**. Enter the wireless network settings, and then tap **Save**.

Adding the Data connection and Wi-Fi widgets

Add the Data connection and/or Wi-Fi widget to the Home screen to make it faster for you to turn on or off these connections. Tap the widget to turn on or off the connection.

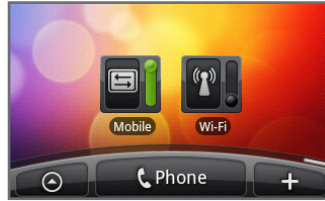

To learn how to add widgets, refer to “Adding a widget to your Home screen” in the Personalizing chapter.

Connecting to a virtual private network (VPN)

From your phone, you can add, set up, and manage virtual private networks (VPNs) that allow you to connect and access resources inside a secured local network, such as your corporate network.

Preparing your phone for VPN connection

Depending on the type of VPN you are using at work, you may be required to enter your login credentials and/or install security certificates before you can connect to your company's local network. You can get this information from your network administrator.

Also, your phone must first establish a Wi-Fi or data connection before you can initiate a VPN connection. For information about setting up and using these connections on your phone, see "Data connection" and "Wi-Fi" in this chapter.

Setting up secure credential storage

If your network administrator instructs you to download and install security certificates, you must first set up the phone's secure credential storage.

1. Press HOME > MENU, tap **Settings** > **Security**, and then tap **Set password**.
2. Enter a new password (at least 8 characters without any spaces) for the credential storage, scroll down and confirm the password, and then tap **OK**.
3. Select the **Use secure credentials** check box.

You can then download and install the certificates needed to access your local network. Your network administrator can tell you how to do this.

Adding a VPN connection

1. Press HOME > MENU, and then tap **Settings** > **Wireless & networks** > **VPN settings**.
2. Tap **Add VPN**, and then tap the type of VPN you want to add.
3. Tap the VPN settings and set them up according to the security details you have obtained from your network administrator.
4. When finished, press MENU, and then tap **Save**.

The VPN is then added to the VPNs section of the VPN settings screen.

Connecting to a VPN

1. Press HOME > MENU, and then tap **Settings** > **Wireless & networks** > **VPN settings**.
2. In the VPNs section, tap the VPN that you want to connect to.
3. When prompted, enter your log in credentials, and then tap **Connect**.
When you are connected, the VPN connected icon  appears in the notification area of the title bar.
4. Open the web browser to access resources such as intranet sites on your corporate network. See "Using your phone's web browser" for more information.

Disconnecting from a VPN

1. Press and hold the title bar, and then slide down your finger to open the Notifications panel.
2. Tap the VPN connection to return to the VPN settings screen, and then tap the VPN connection to disconnect from it.

When your phone has disconnected from the VPN, the VPN disconnected icon  is displayed in the notification area of the title bar.

Using your phone's web browser

Open the web browser to start surfing the web. The browser is fully optimized and comes with advanced features that let you enjoy Internet browsing on your phone.



You must have an active data connection or Wi-Fi connection to access the Internet.

Opening the browser

Do one of the following:

- Press HOME, and then tap **Internet**.
- Press HOME, and then tap  > **Internet**.

Going to a web page

1. On the browser screen, press MENU and then tap the URL field on top of the screen.
2. Enter the web page address using the keyboard. As you enter the address, matching web page addresses will appear on the screen. Tap an address to go directly to that web page or continue entering the web page address.

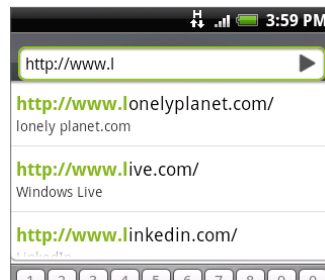

3. Tap the Enter key  on the onscreen keyboard.

Setting your home page

1. Press HOME, and then tap  > **Internet**.
2. Press MENU, and then tap **More** > **Settings** > **Set home page**.
3. On the Set home page screen, select the home page you want to use.

Changing the screen orientation

The phone automatically changes the screen orientation depending on how you are holding your phone.



The **Orientation** check box in HOME > MENU > Settings > Sound & display needs to be selected for the screen orientation to automatically change.

Browsing full versions of all web sites

Some web sites display a mobile version of their pages to phone web browsers. You can choose to view the full version of all pages, even for these sites.

1. Press HOME, and then tap  > Internet.
2. Press MENU, tap More > Settings, and then clear the Mobile view check box.

Navigating on a web page

You can swipe your finger on the screen or the optical trackball to navigate and view other areas of the web page.

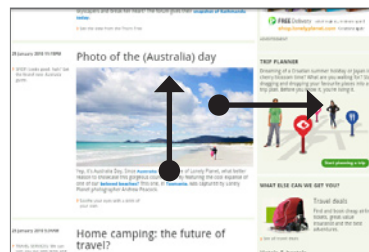

Zooming in or out on a web page

Tap the screen twice quickly to zoom in, then tap the screen twice quickly again to zoom out. You can also use your fingers to pinch or spread the screen to zoom in and out.

Use your thumb and index fingers to 'spread' the web page to zoom in.

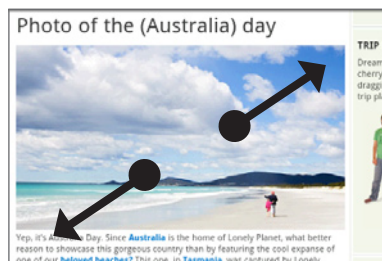

Use your thumb and index fingers to 'pinch' the web page to zoom out.

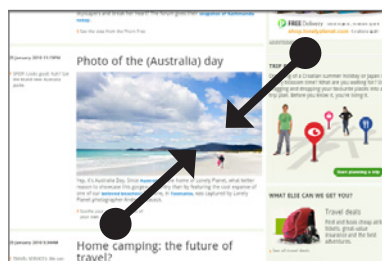

Selecting a link in a web page

You can tap a link with your finger to open it, or press and hold a link for more options.

Link	What to do
Web page address (URLs)	<ul style="list-style-type: none"> ▪ Tap the link to open the web page. ▪ Press and hold the link to open a menu that allows you to open, bookmark, copy to the clipboard, or share the link via email.
Email address	<ul style="list-style-type: none"> ▪ Tap to send an email message to the email address. ▪ Press and hold, then tap Copy on the menu to copy the email address to the clipboard. You can paste the email address later when creating a new contact or sending a new email message.

The browser also recognizes some phone numbers and addresses that allow you to call the phone number or locate the address in Google Maps™. Recognized phone numbers and addresses are highlighted in green when navigated to.

Link	What to do
Location address	Tap the address to open Google Maps and locate the address.
Phone number	Tap to open the Phone screen to call the phone number.

You can also navigate to a link on a web page and select it using the optical trackball. This is particularly useful when viewing text and links at a small size. Links are enclosed in a colored box when selected.

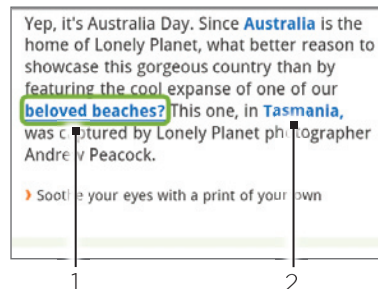

- 1 Link is selected.
- 2 Link is not selected.

After selecting a link with the optical trackball, you can press the optical trackball to open the link, or press and hold the optical trackball for more options.

Opening a new browser window

Open multiple browser windows to make it easier for you to switch from one web site to another. You can open up to 4 browser windows.

1. Press HOME, and then tap  > Internet.
2. Press MENU and then tap Windows.
3. Tap the “+” button.

A new browser window opens and goes to the home page that is set.

Switching between browser windows

1. Press HOME, and then tap  > Internet.
2. Press MENU, and then tap Windows.
3. Select the browser window you want to view by sliding your finger on the screen from right to left.



-
- 1 Tap to close the web page.
 - 2 Tap to display the web page in full screen.
-

Finding text within a web page

1. While viewing a web page, press MENU and then tap More > Find on page.
2. Enter the search item. As you enter characters, matching characters will be highlighted in green. Tap the left or right arrow to go to the previous or next matching item.

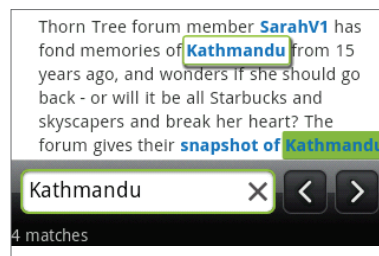

Downloading applications from the web

Before you can download applications from the web, you must first enable downloading from the phone settings.

1. Press HOME > MENU, and then tap Settings > Applications.
2. Select the Unknown sources check box.
3. When the Attention dialog box opens, tap OK.

 All downloaded applications are saved to the storage card. Before you download an application from the web, make sure that you have installed a storage card on your phone. For information on how to install a storage card, refer to the Basics chapter.

 Applications downloaded from the web can be from unknown sources. To protect your phone and personal data, download applications only from trusted sources such as Android Market. Refer to "Finding and installing apps from Android Market" in the More apps chapter for details.

Viewing your downloads

On a browser screen, press MENU and then tap More > Downloads.

Copying text, looking up information, and sharing

You can select text and then:

- Copy it.
- Look it up on Wikipedia or Google Dictionary.
- Get a translation of the text from Google Translate.
- Share the text in a new email, text, or multimedia message or in your status update on a social network.

Selecting text

1. Press and hold on a word.



To select text in a link, press and hold the link, and then tap **Copy text**.

2. Drag the start and end markers to highlight the surrounding text you want to select.



-
- 1 Tap to copy, search/translate, or share the text.
 - 2 Start and end markers. Drag to increase or decrease the text selection area.
-



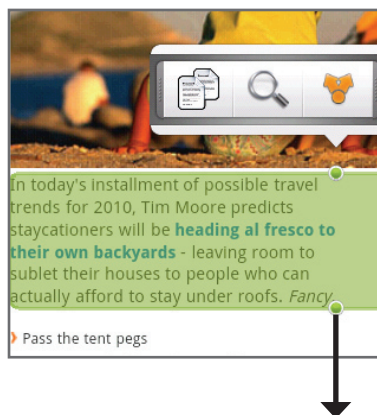

When you select a larger block of text, the appearance of the markers changes. You can drag these markers up or down to select multiple paragraphs of text.



Copying and pasting text

1. After you have selected the text you want to copy, tap . The selected text is then copied to the clipboard.
2. In a text entry field (for example while composing a message), press and hold at the point where you want to paste the text.
3. Tap **Paste**.

Searching or translating text

1. After you have selected the text you want to search or translate, tap .
2. Tap one of the following tabs:
 -  **Wikipedia**. Look for related information on Wikipedia, based on the text that you selected.
 -  **Google Translate**. Translate the text to another language.
 -  **Google Dictionary**. Look up the selected text in the dictionary.

Pasting text in a new message or social network status update

1. After you have selected the text you want to share, tap .
2. Select an option to paste the selected text in a new email, text or multimedia message or in your status update on a social network such as Twitter. See the Email, Messages, and Social chapters for more information on using these features.



Viewing bookmarks and previously visited pages

You can store as many bookmarks as you want on your phone. You can also access a convenient History list of the sites you have visited, or quickly view the pages that you access most often.



Bookmarking a web page

1. While viewing a web page, press MENU, and then tap **Add bookmark**. The New bookmark screen opens.
2. Edit the bookmark **Name** if needed, and then tap **Done**.



Opening a bookmark

1. Press HOME, and then tap  > **Internet**.
2. Press MENU, and then tap **Navigate**.
3. On the Bookmarks tab , navigate to the bookmark you want to open, and then tap it.



Editing a bookmark

1. Press HOME, and then tap  > **Internet**.
2. Press MENU, and then tap **Navigate**.
3. On the Bookmarks tab , press MENU and then tap **Edit**.
4. Tap the bookmark you want to edit.
5. Enter your changes, and then tap **Done**.



Viewing a previously visited page

1. Press HOME, and then tap  > Internet.
2. Press MENU, and then tap **Navigate**.
3. On the History tab , navigate to the page you want to view and then tap the page.



Clearing the list of previously visited pages

1. Press HOME, and then tap  > Internet.
2. Press MENU, and then tap **Navigate**.
3. On the History tab , press MENU, and then tap **Clear history**.



Viewing a page that you often visit

1. Press HOME, and then tap  > Internet.
2. Press MENU, and then tap **Navigate**.
3. On the Most Visited tab , navigate to the page you want to view, and then tap the page.

Clearing the list of most visited pages

1. Press HOME, and then tap  > Internet.
2. Press MENU, and then tap **Navigate**.
3. On the Most Visited tab , press MENU, and then tap **Clear all**.

Changing the view of bookmarks or most visited pages

1. Press HOME, and then tap  > Internet.
2. Press MENU, and then tap **Navigate**.
3. On the Bookmarks tab  or the Most visited tab , press MENU, and then tap **Thumbnails**, **List**, or **Grid** to change the view. For example, if you are in Thumbnails view and you want to view bookmarks in a grid, press MENU > **List**, and then press MENU > **Grid**.

Setting browser options

Customize the web browser to suit your browsing lifestyle. Set display, privacy, and security options when using the web browser.

1. Press HOME, and then tap  > Internet.
2. Press MENU, and then tap **More** > **Settings**.

Using your phone as a modem (tethering)

Get online with your notebook or desktop computer at any time, using your phone's data connection. For information on setting up and using the data connection, see "Data connection" earlier in this chapter.



- You need to install HTC Sync before you can use your phone as a modem. Refer to "Using HTC Sync" in the Sync chapter for details.
 - You need a SIM card installed on your phone to use it as a modem for your computer.
1. Make sure your phone's data connection is turned on. See "Turning the data connection on or off" earlier in this chapter to learn how to turn on the phone's data connection.
 2. Connect the phone to the computer using the provided USB cable.
 3. On the Connect to PC screen, select **Internet sharing**, and then tap **Done**.

When you are using your phone as a modem, the USB mass storage feature is disabled, and you are also not able to use HTC Sync.

Bluetooth

Using Bluetooth

Bluetooth is a short-range wireless communications technology that allows devices to exchange information over a distance of about eight meters without requiring a physical connection.



Turn off Bluetooth when not in use to conserve battery power, or in places where using a wireless device is prohibited, such as on board an aircraft and in hospitals.

Turning Bluetooth on or off

1. Press HOME > MENU, and then tap **Settings > Wireless & networks**.
2. Select or clear the **Bluetooth** check box.

An even easier way to turn Bluetooth on or off is with the Bluetooth widget on the Home screen. For instructions on adding a widget to the Home screen, see “Adding a widget to your Home screen” in the Personalizing chapter.

Changing the phone name

The phone name identifies your phone to other devices.

1. Press HOME > MENU, and then tap **Settings > Wireless & networks**.
2. If the **Bluetooth** check box is not selected, select it to turn Bluetooth on.
3. Tap **Bluetooth settings > Device name**.
4. Enter the name for your phone in the dialog box, and then tap **OK**.

Connecting a Bluetooth headset or car kit

You can listen to music over an Bluetooth stereo headset, or have hands-free conversations using a compatible Bluetooth headset or car kit. It's the same procedure to set up stereo audio and hands-free.

For you to listen to music with your headset or car kit, the headset or car kit must support the A2DP Bluetooth profile.

1. Press HOME > MENU, and then tap **Settings** > **Wireless & networks** > **Bluetooth settings**.
2. If Bluetooth is not switched on, tap the **Bluetooth** check box to switch it on.
3. Make sure that the headset is discoverable, so that your phone can find the headset. Refer to the instructions that came with the headset to find out how to set it in discoverable mode.
4. Tap **Scan for devices**. Your phone will start to scan for Bluetooth devices within range.
5. When you see the name of your headset displayed in the Bluetooth devices section, tap the name. Your phone then automatically tries to pair with the headset.
6. If automatic pairing fails, enter the passcode supplied with your headset.

The pairing and connection status is displayed below the hands-free headset or car kit name in the Bluetooth devices section. When the Bluetooth headset or car kit is connected to your phone, the Bluetooth connected icon  is displayed in the status bar. Depending on the type of headset or car kit you have connected, you can then start using the headset or car kit to listen to music and/or make and receive phone calls.

Reconnecting a headset or car kit

When you have paired a headset with your phone, you should be able to reconnect it automatically by turning on Bluetooth on your phone, and then turning on the headset. However, sometimes you will need to reconnect manually, for example if you have been using your headset with another Bluetooth device.

1. Press HOME > MENU, and then tap **Settings** > **Wireless & networks** > **Bluetooth settings**.
2. If Bluetooth is not switched on, tap the **Bluetooth** check box to switch it on.
3. Make sure that the headset is discoverable.
4. Tap the headset's name in the Bluetooth devices section.
5. If prompted to enter a passcode, try 0000 or 1234, or consult the headset/car kit documentation to find the passcode.

If you still cannot reconnect to the headset or car kit, follow the instructions in "Unpairing from a Bluetooth device" in this chapter, and then follow the instructions under "Connecting a Bluetooth headset or car kit" above.

Disconnecting or unpairing from a Bluetooth device

Disconnecting a Bluetooth device

1. Press HOME > MENU, and then tap **Settings** > **Wireless & networks** > **Bluetooth settings**.
2. In the Bluetooth devices section, press and hold the device to disconnect.
3. Tap **Disconnect**.

Unpairing from a Bluetooth device

You can make your phone forget its pairing connection with another Bluetooth device. To connect to the other device again, you may need to enter or confirm a passcode again.







1. Press HOME > MENU, and then tap **Settings** > **Wireless & networks** > **Bluetooth settings**.
2. In the Bluetooth devices section, press and hold the device to unpair.
3. Tap **Unpair**.

Sending and receiving information using Bluetooth

You can use Bluetooth to transfer information between your phone and another Bluetooth-enabled device such as a phone or notebook computer. The first time you transfer information between your phone and another device, you need to enter or confirm a security passcode. After that, your phone and the other device are paired, and you will not need to exchange passcodes to transfer information in the future.

Sending information from your phone to another device

You can send the following types of information, depending on the device you are sending to:

- Images and videos
 - Calendar events
 - Contacts
 - Audio files
1. Set the receiving device to discoverable mode. You may also need to set it to “Receive Beams” or “Receive Files”. Refer to the device’s documentation for instructions on receiving information over Bluetooth.
 2. On the phone, open the application that contains the information or file you want to send. For example, if you want to transfer a photo, press HOME, and then tap  > Photos.
 3. Follow the steps for the type of item you want to send:
 - **Photo or video** (in Camera). After capturing a photo, on the preview screen, tap the Share button , and then tap **Bluetooth**.
 - **Photos and videos** (in Photos). On the Albums tab , tap an album. Tap the Share button , tap **Bluetooth**, select the items you want to share, and then tap **Next**.
 - **Calendar event**. In the Calendar’s Day view, Agenda view, or Week view, press and hold the event, and then tap **Share vCalendar > Bluetooth**.
 - **Contact**. On the People screen’s All tab , press and hold the contact, and then tap **Send contact as vCard**. Tap the down arrow icon, and then select **Bluetooth** from the displayed list.
 - **Music track**. With the track displayed on the Now playing screen, press MENU, and then tap **Share > Bluetooth**.
 - **Voice recording**. On the main Voice Recorder screen, tap the Share button , and then tap **Bluetooth**.
 4. If you are prompted to turn on Bluetooth, tap Yes.
 5. Tap the name of the receiving device.
 6. If prompted, accept the connection on the receiving device, and enter the same passcode on both your phone and the other device, or confirm the auto-generated passcode.
 7. On the receiving device, accept the file.

The location where the information is saved depends on the type of information and the receiving device:

- If you send a calendar event or contact, it is normally added directly to the corresponding application on the receiving device. For example, if you send a calendar event to a compatible phone, the event is shown in that phone's calendar application.
- If you send another file type to a Windows computer, it is normally saved in the Bluetooth Exchange folder within your personal document folders.
On Windows XP, the path may be: C:\Documents and Settings\[your username]\My Documents\Bluetooth Exchange
On Windows Vista, the path may be: C:\Users\[your username]\Documents
- If you send a file to another device, the saved location may depend on the file type. For example, if you send an image file to another mobile phone, it may be saved in a folder named "Images".

Receiving information from another device

Your device is capable of receiving a wide variety of file types with Bluetooth, including photos, music tracks, and documents such as PDFs.

To receive files from another device, you need to have an SD card installed in your phone.

1. Press HOME > MENU , and then tap **Settings > Wireless & networks > Bluetooth settings**.
2. If Bluetooth is not switched on, tap the Bluetooth check box to switch it on.
3. Tap the **Discoverable** check box.
4. On the sending device, send one or more files to your phone. Refer to the device's documentation for instructions on sending information over Bluetooth.
5. If prompted, enter the same passcode on both your phone and the other device, or confirm the auto-generated passcode. A Bluetooth authorization request is displayed on your phone.
6. If you want to automatically receive files from the sending device in future, select the **Always trust device** check box.
7. Tap **OK**.
8. When your phone receives a file transfer request notification, slide down the notifications panel, and then tap **Accept**.
9. When a file is transferred, a notification is displayed. To open the file immediately, slide down the notifications panel, and then tap the relevant notification.

When you open a received file, what happens next depends on the file type:

- Media files and documents are usually opened directly in a compatible application. For example, if you open a music track, it starts playing in the Music application.
- For a vCalendar file, select the calendar where you want to save the event, and then tap **Import**. The vCalendar is added to your Calendar events. For information on using Calendar, see the Calendar chapter.
- For a vCard contact file, if there are multiple vCard files on your storage card, you can choose to import one, several, or all of those contacts to your contacts list.

Adding the Bluetooth received folder to the Home screen

You can add a folder to the Home screen that shows all files you have received with Bluetooth.

1. Press HOME, and then tap .
2. On the Add to Home screen, tap **Folder > Bluetooth received**.
3. Press and hold the Bluetooth received folder icon, and drag it to the Home screen position you want.

To view the folder contents, tap the folder icon. To open a file, tap the file name.

Camera

Camera basics

Whether traveling for business or fun, enjoy taking photos and videos of your trip and encounters with your phone's camera.



Be sure to plug in your microSD card before you use your phone's camera. Photos and videos captured with the camera will be stored onto your microSD card.

If you have not yet inserted your microSD card to your phone, follow the steps in “Inserting the storage card” in the Basics chapter to insert it.

- To open the camera in photo mode and take photos, press HOME and then tap **Camera**.
- To open the camera directly in video mode so you can immediately start capturing videos, press HOME, tap , and then tap **Camcorder**.

Viewfinder screen

The camera displays in landscape view only. You'll find the following controls on the Viewfinder screen:

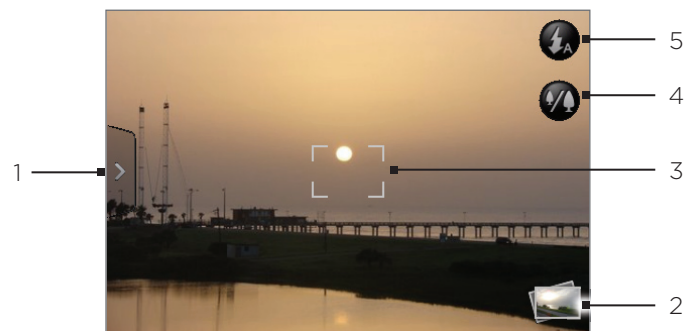

1  **Menu tab**

Tap to open the menu panel and change camera settings.
See “Changing camera settings” for details.

2  **View button**

Tap to open the Photos application so you can browse through and view the photos and videos in your storage card.
See the Photos chapter for details.

3  **Auto-focus indicator**

Whenever you point the camera at a different subject or location, the screen shows the auto-focus indicator at the center as the camera automatically focuses on the center of the screen.

When you tap another area on the screen, the indicator will move to where you tapped and the camera will automatically focus on that area.

4  **Zoom button**

Tap to display or hide the onscreen zoom bar.
See “Zooming” for details.

5  **Flash button**

Tap to switch between the different camera flash modes.

Using the optical trackball as the shutter release

The optical trackball works as the shutter release for the camera. Press the optical trackball to take a photo or begin capturing video. Press it again to stop capturing video.

Review screen

After capturing a photo or video, the Review screen will display the photo or the starting image of the video that you have just captured. You can tap the onscreen buttons to delete the photo or video, view it in the Photos application, or share it.



Back

Return to the Viewfinder screen.



Delete

Delete the captured image or video.



Share

Send the captured photo or video to another phone or your computer using Bluetooth, send it by email, or select a social network where you want to upload it to.



View

Open and use the Photos application to view the captured photo or video, rotate your captured photo, and more. See the Photos chapter for details.

Zooming

Before taking a photo or video, you can first use the onscreen zoom bar to zoom in or out of your subject.



1. To display the onscreen zoom bar, tap the **Zoom** button . You can also slide your finger up or down the Viewfinder screen.

While the zoom bar is shown on the Viewfinder screen, you will also see the remaining photo shots or remaining video recording duration on the upper-right side of the screen.



2. You can do the following:

- To slowly zoom in or out, slide your finger up or down the Viewfinder screen. You can also drag your finger across the zoom bar.



- Tap  to zoom in to the highest magnification.
 - Tap  to zoom out to the actual size.
3. After you're done, wait for a few seconds for the zoom bar to automatically disappear from the screen. You can also tap the **Zoom** button again or tap the Viewfinder screen to hide it.

Taking a photo

1. Press HOME and then tap **Camera**.
2. Before taking the photo, you can zoom in first on your subject. See “[Zooming](#)” to find out how to use the onscreen zoom bar.
3. On the Viewfinder screen, tap the **Flash** button repeatedly to select a camera flash mode depending on your lighting conditions:
 -  Auto flash
 -  Flash on
 -  Flash off
4. Frame your subject on the Viewfinder screen.
5. Let the camera auto focus on the center of the screen, or you can touch another area on the screen that you want to focus on.
6. Press the optical trackball to take the photo.
7. Choose what you want to do with the photo you’ve just taken. See “[Review screen](#)” for details.

Camera flash doesn’t turn on?

Using the flash eats up much battery power. To save battery power, the camera disables the flash (even when you have set the camera flash mode to **Auto flash** or **Flash on**) when one of the following occurs:

You have an incoming call

The flash will be disabled temporarily when you have an incoming call. After the call ends, you’ll be able to use the flash again.

If you have set the flash mode to **Flash on**, it turns back on after you answer and end the call.

Your phone’s battery level reaches 15% or lower

Recharge the battery so that the camera can have enough battery power to use the flash.

Cold weather may lower battery performance which affects the flash

To make sure the camera has enough battery life to power up the flash, keep your phone warm. When not in use, put the phone inside your jacket to keep it warm, and try to avoid sudden temperature changes that may affect battery performance.

Capturing a video

1. Press HOME, tap , and then tap **Camcorder**.
2. Before capturing video, you can zoom in first on your subject. See [“Zooming”](#) to find out how to use the onscreen zoom bar.
3. Frame your subject on the screen.
4. Let the camera auto focus on the center of the screen, or you can touch another area on the screen that you want to focus on.
5. Press the optical trackball to start capturing video.

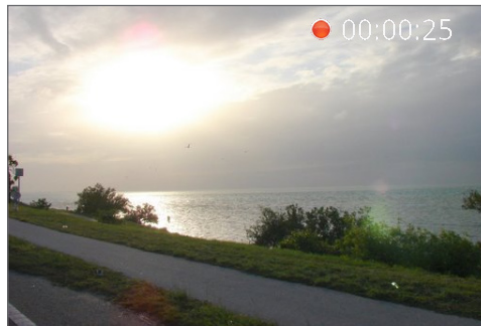

6. To stop capturing, press the optical trackball again.
7. Choose what you want to do with the video you've just captured. See [“Review screen”](#) for details.

Camera settings

Open the menu panel to change basic camera settings and access more camera settings. You can also switch between photo and video modes from the menu panel.

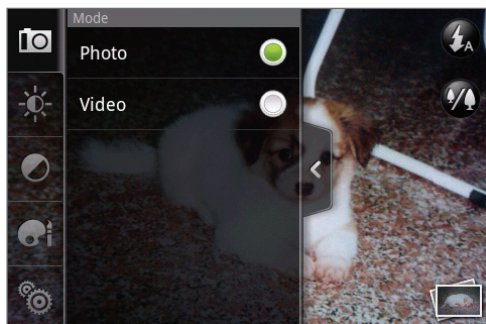

Changing basic settings

1. On the Viewfinder screen, tap  to open the menu panel.
2. To change basic camera settings, tap one of these icons in the menu panel:



Exposure

There's a Brightness bar that allows you to adjust the brightness level. Slide your finger up or down the Brightness bar to increase or decrease brightness.



Image properties



Slide your finger across each of the slider bars to adjust the contrast, saturation, and sharpness.



Effect

You can apply a special effect to photos and videos that you will capture. Scroll through the Effect menu and choose from effects such as sepia, solarize, posterize, and more.

Changing advanced settings

1. On the Viewfinder screen, tap  to open the menu panel.
2. Tap  in the menu panel to display the Settings menu and access more camera settings. The following are settings that you can change from the Settings menu:

White balance

White balance enables the camera to capture colors more accurately by adjusting to your current lighting environment. White balance settings include: Auto, Incandescent, Fluorescent, Daylight, and Cloudy.

ISO (photo mode only)

You can choose an ISO level or set it back to Auto. Higher ISO numbers are better for taking pictures in low light conditions.

Resolution

Select a photo or video resolution to use for capturing.

Widescreen (photo mode only)

When this check box is selected (default), photo resolutions available for selection are in 3:2 ratio and you can use the entire Viewfinder screen to frame your subject. When not selected, photo resolutions available for selection are in standard 4:3 ratio.

Quality (photo mode only)

Select the quality level to use for capturing photos.

Self-timer (photo mode only)

If you need to take a self-portrait or group photo, you can set the self-timer to either 2 or 10 seconds.

Geo-tag photos (photo mode only)

Select this check box when you want to store GPS location in your captured photos.

Encoding type (video mode only)

Choose the type of compression to use when capturing video.

Recording length (video mode only)

Set the maximum duration or file size for capturing video.

Record with audio (video mode only)

Select or clear the check box, depending on whether you want to record audio when capturing videos.

Metering mode

Set how the camera measures the amount of light to calculate the best exposure:

- **Spot** metering mode allows the camera to measure light around the focus point.
- **Center area** mode allows the camera to measure light in the center.
- **Average** mode allows the camera to measure light in the whole image.

Review duration

Set the time for a captured photo or video to be displayed on the Review screen before the camera changes back to the Viewfinder screen.

Flicker adjustment

When taking indoor shots under fluorescent lighting, keep this setting on Auto or change it to the proper frequency (50Hz or 60Hz) of the power in your country to reduce flicker.

Auto Focus

This option enables or disables centered auto focus. Auto focus is enabled by default.

Shutter sound

Select or clear this check box, depending on whether you want the camera to play a shutter sound when you press the shutter release.

Time stamp (photo mode only)

Select this check box when you want the date and time to be added on captured photos.

Grid (photo mode only)

Select this check box when you want to display a grid on the Viewfinder screen so you can easily frame and center your subject before taking the photo.

Reset to default

Tap to change the camera back to default settings.

Photos

About the Photos application

Using the **Photos** application, you can view photos and watch videos that you've taken with your phone's camera, downloaded, or copied onto your storage card. You can also take a look at your photos and your friends' photos that are on your social networks (Facebook and Flickr only).

For photos that are in your storage card, you can do basic editing such as rotate and crop. You can also easily make a photo as your contact picture or wallpaper and share photos to your friends.

Selecting an album

To open the Photos application, press HOME, tap , and then tap **Photos**.

The Photos application opens in the Albums screen where your photos and videos are organized by albums for easy viewing.

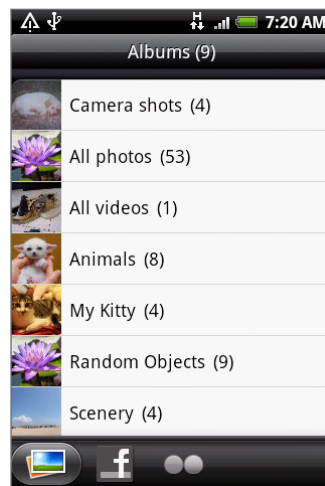

The following are preset albums:

- **Camera shots** lets you view photos and videos that are stored in the camera's folder.
- Photos and videos that you set as your favorites will be grouped under **My favorites**.
- **All photos** lets you view all photos that are stored in all the folders on the storage card.
- **All videos** lets you view all videos that are stored in all the folders on the storage card.
- **All downloads** lets you view photos and videos that you downloaded.

Folders in your storage card that contain photos and videos will also be treated as albums and will be listed below the preset albums. The actual folder names will be used as the album names.

Simply tap an album to view the photos and/or videos in that album.



If there are photos or videos under the root path of your storage card (that are not contained in folders), they will be grouped under the **Other** album.

Viewing photos and videos

After selecting an album from the Photos application's Albums screen, you can browse through the photos and videos of that album either in filmstrip or grid view. Tap a photo or video to view it in full screen.

Browsing in filmstrip or grid view

By default, photos and videos are presented in a horizontal filmstrip. Slide your finger left or right across the filmstrip to go through the photos and videos.

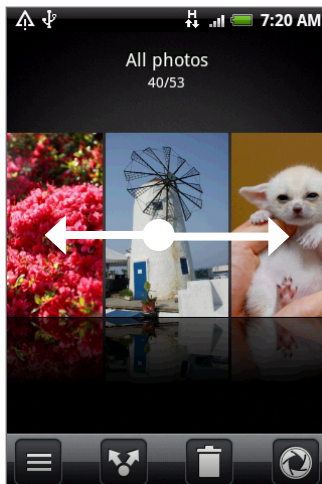

From the filmstrip view, press MENU and then tap **Grid view** to browse photos and videos by thumbnails. Slide your finger up or down to scroll through the thumbnails.

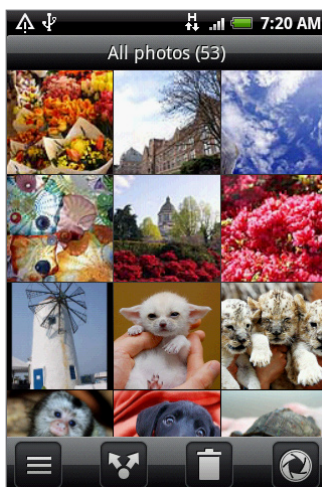

To change back to displaying photos and videos in a filmstrip, press MENU and then tap **Filmstrip view**.



- Whether you're in filmstrip or grid view, you can press and hold on a photo or video to open a selection menu and choose what to do with the photo or video.
- If you want to select another album, tap to return to the Photos application's Albums screen.

Viewing a photo in landscape orientation

Turn your phone sideways to the left to view the picture in landscape mode. The picture orientation automatically adjusts to how you hold the phone.

Zooming in or out on a photo

There are two ways you can zoom in or out of a photo:

- Tap the screen twice quickly to zoom in, then tap the screen twice quickly again to zoom out.
- You can also use pinch zooming. Press your thumb and index finger on the screen and then spread your fingers apart to zoom in. Pinch your fingers together to zoom out.

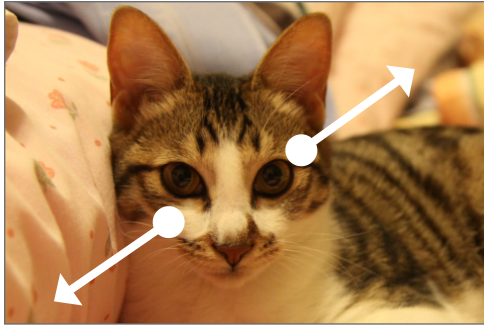

Zooming in

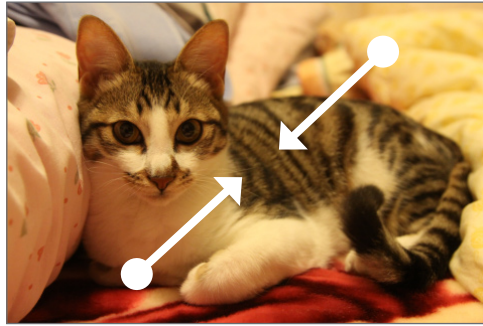

Zooming out

Watching video

The screen automatically switches to landscape mode when you play a video. Use the onscreen controls to play, pause, or stop the video.

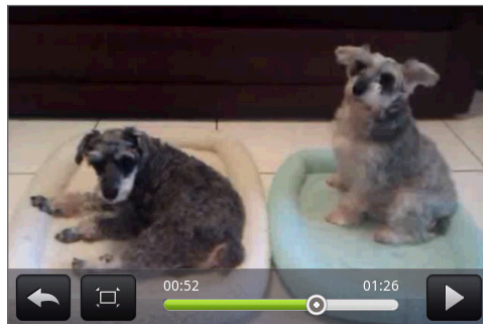

The video is displayed in full screen size. You can tap  to make it best fit on the screen based on the video size. Tap the button again to change back to full screen size.

Viewing photos in your social networks

Using the Photos application, you can view your photos and your friends' photos that are in your social networks (Facebook and Flickr only).

Viewing photos on Facebook

You need to be logged in to your Facebook account to view Facebook photos.

1. Press HOME, tap , and then tap **Photos**.
2. Tap the **Facebook** tab.
3. Tap your account name or your friend's account on the list to view the pictures in the account.

You can view photos in your online albums the same way as how you view photos in your storage card.

Viewing photos on Flickr

You need to be logged in to your Flickr account to view Flickr photos.

1. Press HOME, tap , and then tap **Photos**.
2. Tap the **Flickr** tab.

You may be asked to give authorization for the application to connect to the Flickr website. If this happens, you need to give authorization to access your Flickr account.
3. Tap your account name or your friend's account on the list to view the photos in the account.

You can view photos in your online albums the same way as how you view photos in your storage card.

Working with photos

Whether you're browsing photos in filmstrip or grid view in the Photos application, you can press and hold on a photo to open a selection menu and choose what to do with it. You can choose to delete the photo, rotate or crop it, and more.

Rotating and saving a photo

1. Press HOME, tap , and then tap **Photos**.
2. From the Photos application's Albums screen, tap an album.
3. Choose whether to browse photos and videos in the album in filmstrip or grid view. See "Browsing in filmstrip or grid view" for details.
4. Press and hold on the photo that you want to rotate.
5. In the menu that opens, tap **Rotate**, and then select either **Rotate left** or **Rotate right**.



You can also rotate a photo while you're viewing it in full screen. Press MENU, tap **Rotate**, and then select either **Rotate left** or **Rotate right**.

Cropping a photo

1. Press HOME, tap , and then tap **Photos**.
2. From the Photos application's Albums screen, tap an album.
3. Choose whether to browse photos and videos in the album in filmstrip or grid view. See "Browsing in filmstrip or grid view" for details.
4. Press and hold on the photo that you want to crop.
5. In the menu that opens, tap **Crop**. A crop box then appears on the photo.



6. To adjust the crop box size, press and hold the edge of the box. When directional arrows appear, drag your finger inward to or outward to resize the crop box.
7. To move the crop box to the part of the photo that you want to crop, drag the crop box to the desired position.
8. Tap **Save** to apply the changes to the picture.

The cropped picture is saved in the storage card as a copy. The original picture remains unedited.





You can also crop a photo while you're viewing it in full screen. Press MENU, tap More > Crop, and follow the same cropping steps as above.

Sharing

Using the Photos application, you can send photos and videos via email or MMS. You can share photos on your social networks (such as Facebook, Flickr, Picasa, and Twitter) and share videos on YouTube. You can also send them to another phone or your computer using Bluetooth.

Sending photos or videos by email

You can send several photos, videos, or both in an email message. They are added as file attachments in your email.



1. Press HOME, tap , and then tap **Photos**.
2. Tap the album where the photos or videos you want to share are in.
3. Tap  and then on the **Share** options menu, tap **Gmail/Google Mail** or **Mail**.
4. Select the photos or videos you want to share and then tap **Next**.
5. Compose your message and then tap **Send**.



If you selected **Mail** and you have multiple email accounts, the default email account will be used.



Sending a photo or video by MMS

Although you can send several photos or videos in a multimedia message, it may be better to just send one at a time, especially if the files are big in size.

1. Press HOME, tap , and then tap **Photos**.
2. Tap the album where the photo or video you want to share is in.
3. Tap  and then on the **Share** options menu, tap **Messages**.
4. Tap the photo or video you want to send.
5. The photo or video is automatically added into the MMS message.
6. Compose your message and then tap **Send**.



Sending photos or videos using Bluetooth

You can select several photos, videos, or both and send them to someone's phone or your computer using Bluetooth.

1. Press HOME, tap , and then tap **Photos**.
2. Tap the album where the photos or videos you want to share are in.
3. Tap  and then on the **Share** options menu, tap **Bluetooth**.
4. Select the photos or videos you want to share and then tap **Next**.
5. In the next few steps, you'll be asked to turn on Bluetooth on your phone and connect to the receiving Bluetooth device so the files can be sent. Follow the steps in "Sending information from your phone to another device" in the Bluetooth chapter.



Sharing photos on Facebook

You need to be logged in to your Facebook account to be able to upload pictures.

1. Press HOME, tap , and then tap **Photos**.
2. Tap the album where the photos you want to share are in.
3. Tap  and then on the **Share** options menu, tap **Facebook for HTC Sense**.
4. Select the pictures you want to share and then tap **Next**.
5. Select which album to upload to and set privacy settings for the uploaded pictures. Tap **Done**.



Sharing photos on Flickr

You need to be logged in to your Flickr account to be able to upload pictures.

1. Press HOME, tap , and then tap **Photos**.
2. Tap the album where the photos you want to share are in.
3. Tap  and then on the **Share** options menu, tap **Flickr**.
4. Select the pictures you want to share and then tap **Next**.
5. Select which album to upload to and set privacy settings for the uploaded pictures. Tap **Done**.



Sharing photos on Picasa

You need to be signed in to a Google Account to be able to upload pictures to the Picasa™ photo organizing service.

1. Press HOME, tap , and then tap **Photos**.
2. Tap the album where the photos you want to share are in.
3. Tap  and then on the **Share** options menu, tap **Picasa**.
4. Select the pictures you want to share and then tap **Next**.
5. Select the online album where you want to upload the pictures, or tap  to create a new album.
6. Tap **Upload**. You can view the photos online at <http://picasaweb.google.com>.

Sharing videos on YouTube

You can share your videos by uploading them to YouTube™. Before you do this, you must create a YouTube account and sign in to that account on your phone.

1. Press HOME, tap , and then tap **Photos**.
2. Tap the album where the videos you want to share are in.
3. Tap  and then on the **Share** options menu, tap **YouTube**.
4. Select the videos you want to share and then tap **Next**.
5. Enter the prompted information, such as description and tags, and select a privacy option.
6. Tap **Upload**.

Music

About the Music application

Enjoy listening to songs and music on your phone using the **Music** application. You need to copy music files to your storage card first to use the Music application to play music. To find out how to copy files, see “Copying files to and from the storage card” in the Basics chapter.

Playing music

To open the Music application, press HOME, tap , and then tap **Music**.

The Music application opens in the Playback screen. Use the onscreen controls to control music playback, select a song to play, repeat songs, and more. On the Playback screen, you can also swipe your finger from right to left or left to right to go to the next or previous music album.

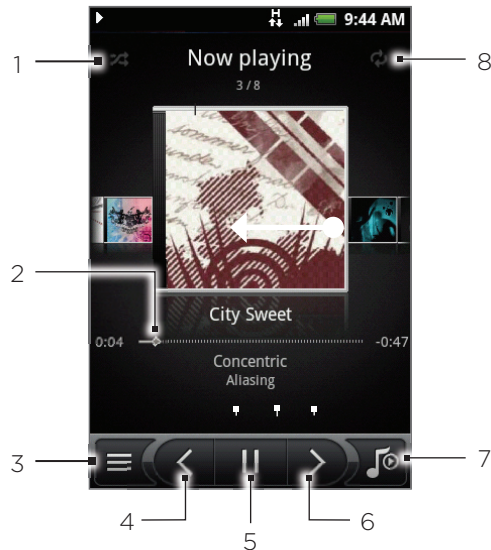

-
- 1 Tap to turn shuffle on or off. (Shuffle is off when button is gray.)
 - 2 Press and drag your finger across the progress bar to jump to any part of the song.
 - 3 Tap to go to the Library.
 - 4 Tap to go to the previous song in the Now playing list.
 - 5 Tap to play, pause, or resume playing the song.
 - 6 Tap to go to the next song in the Now playing list.
 - 7 Tap to toggle between showing the Now playing list and Playback screen.
 - 8 Tap to cycle through the repeat modes: Repeat all songs, Repeat current song, and Don't repeat.
-

When you are playing music and the screen turns off, you can control the music playback right from the Lock screen when you “wake up” the phone by pressing POWER. If you do not see the playback controls on the Lock screen, tap anywhere on the screen to display the playback controls.



- Press the VOLUME UP or VOLUME DOWN button to adjust the playback volume.
- If you are using the wired headset to listen to music, press the center button to toggle between playing and pausing playback. Press the previous or next button to go to the previous or next song.

Browsing music in the Library

Tap  at the bottom-left corner of the Music application's Playback screen or Now playing list to go to the Library.

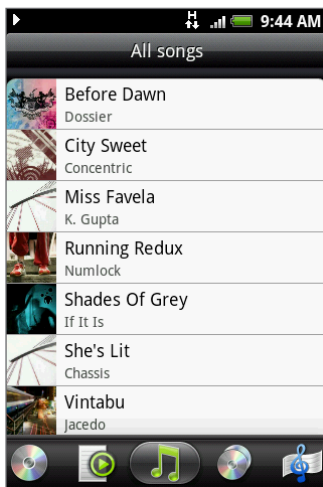



In the Library, your music is organized into different categories such as Albums, Artists, Genres, Composers, and more. Select a category by tapping one of the category tabs at the bottom of the screen.

When you tap a song in a category to play it, the Now playing list is updated with the song list from your selected category.

Creating a playlist

Personalize your music experience by creating music playlists. Make a playlist containing just your favorite songs or create one to match your mood for the day. You can make as many playlists as you like.

1. Press HOME, tap , and then tap **Music**.
2. Tap  at the bottom-left corner of the screen to go to the Library.
3. In the Library, tap or slide your finger on the bottom row to go to the **Playlists** category.
4. Tap **Add playlist**.
5. Enter a playlist name, and then tap **Add songs to playlist**.
6. Tap or slide your finger on the bottom row to change among the different categories. If you go to the **Songs** category, you can see a complete list of songs on your storage card.
7. Select the check boxes of songs you want to add to the playlist and then tap **Add**.
8. Tap **Save**.

Playing the songs in a playlist

1. In the Library, tap or slide your finger on the bottom row to go to the **Playlists** category.
2. Tap a playlist to open it.
3. Tap the first song or any song in the playlist.

When you tap a song in the list to play it, the Now playing list is updated with the song list from your playlist.

Managing playlists

After creating a playlist, you can add more songs to it, rearrange their order, and more.

Adding more songs to a playlist

1. In the Library, tap or slide your finger on the bottom row to go to the **Playlists** category.
2. Tap a playlist to open it.
3. Press MENU and then tap **Add songs**.
4. Go to the **Songs** category or any other category.
5. Select the songs you want to add to the playlist and then tap **Add**.



While playing back a song, press MENU and then tap **Add to playlist** to add the current song to a playlist.

Rearranging songs in a playlist

1. In the Library, tap or slide your finger on the bottom row to go to the **Playlists** category.
2. Tap a playlist to open it.
3. Press MENU and then tap **Change order**.
4. Press and hold  at the end of the song title you want to move. When the row is highlighted, drag it to its new position, then release.
5. Tap Done.

Deleting songs from a playlist



1. In the Library, tap or slide your finger on the bottom row to go to the **Playlists** category.
2. Tap a playlist to open it.
3. Press MENU and then tap **Remove songs**.
4. Select the songs you want to delete and then tap **Remove**.

Deleting playlists

1. In the Library, tap or slide your finger on the bottom row to go to the **Playlists** category.
2. Press MENU and then tap **Delete playlists**.
3. Select the playlists to delete and then tap **Delete**.

Setting a song as ringtone

You can select a song from the Music application's Library and set it as your phone's ringtone or a ringtone for a certain contact.

1. Press HOME, tap , and then tap **Music**.
2. Tap  at the bottom-left corner of the screen to go to the Library.
3. In the Library, select the song that you want to use as ringtone and then play it back.
4. On the Playback screen, press MENU and then tap **Set as ringtone**.
5. In the Set as ringtone options menu, tap **Phone ringtone** or **Contact ringtone**.



If you select **Contact ringtone**, you need to select the contacts you want to associate the song with in the next screen.

Checking if the song was added as a ringtone

1. On the Home screen, press MENU and then tap **Settings**.
2. On the Settings screen, tap **Sound & display > Phone ringtone**. The song should be in the ringtone list and selected.

Sending music using Bluetooth

You can select a song from the Music application's Library and send it to someone's phone or your computer using Bluetooth.

1. Press HOME, tap , and then tap **Music**.
2. Tap  at the bottom-left corner of the screen to go to the Library.
3. In the Library, select the song that you want to use as ringtone and then play it back.
4. On the Playback screen, press MENU and then tap **Share > Bluetooth**.
5. In the next few steps, you'll be asked to turn on Bluetooth on your phone and connect to the receiving Bluetooth device so the music can be sent. Follow the steps in "Sending information from your phone to another device" in the Bluetooth chapter.

About the Music widget

You can use the Music widget to play music right from your Home screen. To find out how you can add this widget to your Home screen, see "Personalizing your Home screen with widgets" in the Personalizing chapter.

Maps and location

Using Google Maps

Google Maps lets you track your current location, view real-time traffic situations, and receive detailed directions to your destination. It also provides a search tool where you can locate places of interest or an address on a vector or aerial map, or view locations in street level.



- You need an active mobile data or Wi-Fi connection to use Google Maps.
- The Google Maps application does not cover every country or city.

Viewing locations

Turning on location services

Before you open Google Maps and find your location or search for places of interest, you must enable location sources.

1. Press HOME > MENU and then tap **Settings > Location**.
2. Select **Use wireless networks**, **Use GPS satellites**, or both.



Selecting **Use GPS satellites** lets you locate places of interest at street level. However, this requires a clear view of the sky and more battery power.

Finding your location

1. Press HOME, and then tap  > Maps.
2. On the Google Maps screen, press MENU and then tap **My Location**. Your location is shown on the map as a blinking blue dot.

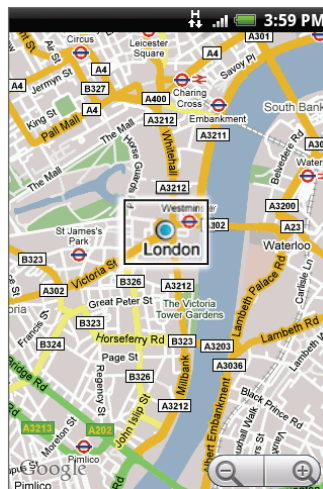

Moving on the map

Swipe your finger on the screen or the optical trackball to view other areas of the map.

Zooming in or out of a map

Tap  to zoom in; tap  to zoom out.

Getting an address and additional information for a location

Touch & hold a location on the map. A balloon opens over the location, with the address and a thumbnail from street view (if available). Tap the balloon to see more information or to get directions to that location.

Looking at a location in Street View

Street View mode (available only in selected areas) provides a street-level view of the location.

1. Do one of the following:
 - Touch and hold a location on the map, and then tap the balloon that appears.
 - Search for the place you want to view in Street View. See “Searching for a location” in this chapter for details. When you find the place, tap its balloon.
2. On the location details screen, tap **Street view**.
3. To navigate in Street View, do any of the following:
 - Swipe your finger on the screen or the optical trackball to pan up or down or to look in other directions.
 - Tap the displayed arrows to move up and down the street.
 - Press MENU to select from other navigation options.



While viewing a Street View of a location, press MENU and then tap **Compass mode** to turn Compass mode on. Tilt, pan, or turn your phone to view the area around the selected location.

Clearing the map

After you get directions or search on a map (as described in the other parts of this section), you can clear away the various markers such activities draw on the map.

When viewing a map, press MENU and then touch **More > Clear map**.

Viewing map layers

Initially, Google Maps opens with a street map. You can view additional map layers, such as satellite images, traffic information, your Google Latitude friends' locations, and Wikipedia information on locations. You can also view maps that you and other people have created in Google Maps on the web.



- Multiple layers can be viewed at the same time.
- Not all locations have information to support all Map layers or all zoom levels. To learn more about layers, visit Google Maps on the web: <http://maps.google.com/>

1. While viewing a map, press MENU, and then tap **Layers**.

2. Select any of the following.

- **Traffic** (available only in selected areas). Real-time traffic conditions are displayed over roads as color-coded lines. Each color represents how fast the traffic is moving.

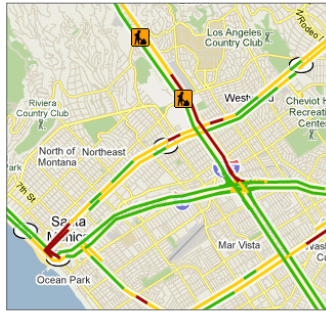

- **Satellite**. Google Maps uses the same satellite data as Google Earth™. Satellite images are not real-time. Google Earth acquires the best imagery available, most of which is approximately one to three years old.

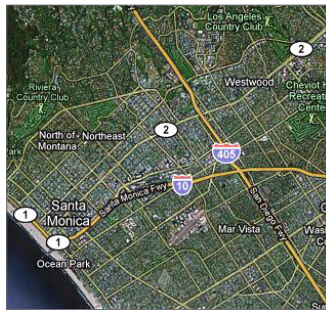

- **Latitude**. When you have joined Latitude, you can view your friends' locations as a layer on the map. For information, see “Finding your friends with Google Latitude (available by country)” in this chapter.
- To select more layers such as transit lines or maps that you have created in Google Maps on the web, tap **More layers**.
- To clear layers and view only the street map, tap **Clear map**.

Searching for a location

1. While viewing a map, press SEARCH.
2. Enter the place you want to search in the search box. You can enter an address, a city, or type of business or establishment (for example, museums in london).

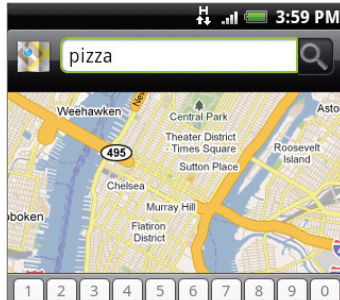

As you enter information, a list of all the places which you have searched or visited before appears on the screen. You can also tap an address on the menu to show its location on the map.

3. Tap . The search results are displayed on the map.

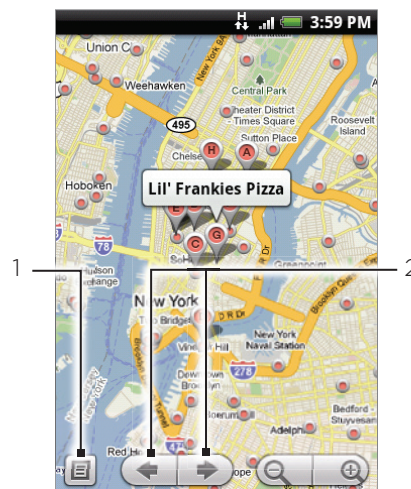

-
- 1 Tap to show the search results as a list.
 - 2 Tap to go to the previous or next search item on the map if there are multiple search results.
-

4. Tap the callout to show the **Address**, **Details** (if available), and **Reviews** (if available) for the search item.

Getting directions

Use Google Maps to get detailed directions to your destination.

1. While viewing a map, press MENU and then tap **Directions**.
2. Enter the starting point in the first text box, then enter your destination in the second text box. By default, your current location is entered in the **Starting point** box.

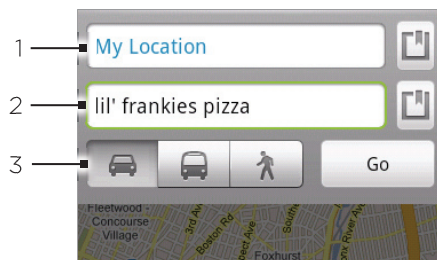

-
- 1 Starting point.
 - 2 Destination.
 - 3 Choose how you want to get to your destination.
-

You can also tap  to open the location source menu and select a starting point and destination address.

3. Tap the icon for car, public transit, or walking directions.
4. Tap **Go**. The directions to your destination appear in a list. Tap a direction instruction on the list to show the map.

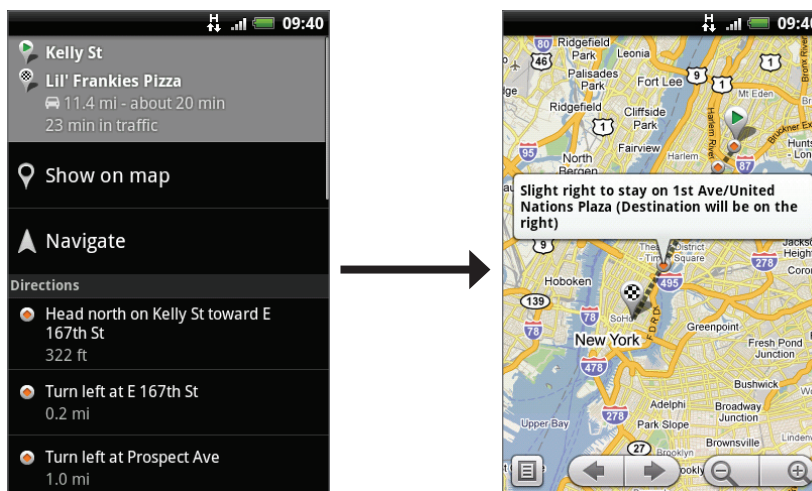

When you are finished viewing or following the directions, press MENU and then tap **More > Clear map** to reset the map. Your destination is automatically saved in the Google Maps history.

Finding your friends with Google Latitude (available by country)

Google Latitude™ user location service lets you and your friends share locations and status messages with each other. It also lets you send instant messages and emails, make phone calls, and get directions to your friends' locations.

Your location is not shared automatically. You must join Latitude, and then invite your friends to view your location or accept their invitations.

Joining Latitude

1. While viewing a map, press MENU and then tap **Join Latitude**.
2. Read the privacy policy. If you agree with it, tap **Agree & share**.

After you join Latitude, you can start sharing your locations with your friends. Only friends that you have explicitly invited or accepted can see your location.

Inviting friends to share their locations

1. While viewing a map, press MENU, and then tap **Latitude**.
2. In Latitude, press MENU, and then tap **Add friends**.
3. Choose how to add friends:
 - **Select from Contacts**. Select any number of friends from your Contacts.
 - **Add via email address**. Enter an email address.
4. Tap **Add friends**.
5. If prompted, tap **Yes**.

If your friends already use Latitude, they receive an email request and a notification on Latitude. If they have not yet joined Latitude, they receive an email request that tells them to sign in to Latitude with their Google Account.

Responding to an invitation

When you get a sharing request from a friend, you can:

- **Accept and share back**. You and your friend can see each other's locations.
- **Accept, but hide my location**. You can see your friend's location, but they can't see yours.
- **Don't accept**. No location information is shared between you and your friend.

Viewing your friends' locations

You can view your friends' locations on a map or in a list.

When you open Maps, your friends' locations are shown. Each friend is represented by their picture (from Contacts) with an arrow pointing to their approximate location. If a friend has chosen to share city-level locations, their picture does not have an arrow and appears in the middle of the city.

To see a friend's profile and connect, touch the photo. Your friend's name appears in a balloon. Touch the balloon to open a screen with details about your friend and many connection options.

When you open Latitude you see a list of your Latitude friends, with a summary of their last known locations, status, and so on. Touch a friend in the list to open a screen with details about the friend and many connection options.

Connecting with and managing friends

Tap a friend's contact details balloon in map view or tap a friend in list view to open the friend's profile. In the profile screen, you can communicate with your friend and set privacy options.

Show on map

Shows the friend's location on the map.

Chat using Google Talk

Opens a Google Talk chat window with that friend.

Send email

Opens Gmail/Google Mail with a message addressed to the friend.

Get directions

Gets directions to the friend's location.

Sharing options

Select from the following:

- **Best available location.** Share your precise location information.
- **Share only city level location.** Share only the city you are in, not the street-level location. Your friend can see your photo icon in the middle of the city you are in. To share more precise location again, tap **Best available location**.
- **Hide from this friend.** Stop sharing your location with this friend, in a list or on a map.

Remove this friend

Remove the friend from your list and stop sharing locations with him or her altogether.

Changing privacy settings

You have control over how and when you can be found by your friends. Only the last location sent to Latitude is stored with your Google Account. If you turn off Latitude or are hiding, no location is stored.

1. In Google Maps, press MENU, and then tap **Latitude**.
2. Tap your own name, and then tap **Edit privacy settings**.
3. Set the following options to your preferences:

Detect your location

Let Latitude detect and update your location as you move. The update frequency is determined by several factors, such as how recently your location has changed.

Set your location

Choose from several options to manually select your location.

Hide your location

Hide your location from all your friends.

Turn off Latitude

Disable Latitude and stop sharing your location or status. You can always join Latitude again.

Using HTC Footprints™

HTC Footprints™ provides an easy way to record favorite places and revisit those places. A footprint consists of a photo you take of a location such as a restaurant, a sightseeing destination, etc., stored together with a precise GPS position and other information about that location such as the street address and phone number.

The next time you want to visit the same place, simply access the footprint. You can then dial the phone number or view the location in Google Maps.

Creating a footprint

1. Press HOME, and then tap  > Footprints.
2. Tap **New Footprint**. If GPS is not on, you are prompted to turn it on so that your phone can use GPS to find your location.
3. Point the camera at the scene you want to show the location. Footprints starts to use GPS to search for your position.



To change brightness and white balance settings before you take a photo, press MENU, tap **Brightness** or **White balance**, and then choose a setting.

4. Press the optical trackball to capture the photo. If your GPS position has not been found yet, you are asked whether to find the position on Google Maps, continue the GPS search, or stop the GPS search. You may also be asked if you want HTC Footprints to automatically determine the address for the location.
6. Tap **Done**.



Before pressing **Done**, you can press MENU, and then tap **Edit** to change the name, category, or address of the footprint, enter the phone and website, and add a voice memo to the footprint.

Revisiting a footprint

1. Press HOME, and then tap  > Footprints.
2. At the bottom of the screen, slide your finger to select the footprint category.

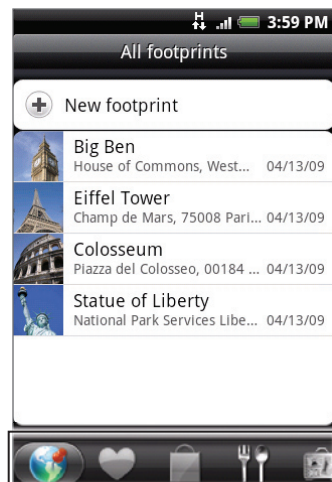

3. Tap the footprint you want to revisit.

4. Scroll down to see more information. You can tap the information fields to view more information about the footprint, call a stored phone number, and more.

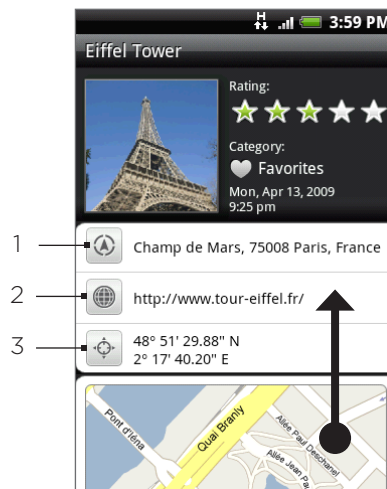

-
- 1 Show the address in Google Maps.
 - 2 Open the web page.
 - 3 Show the GPS location in Google Maps.
-

Editing or deleting a footprint

1. Press HOME, and then tap  > Footprints.
2. On a category screen, press and hold the footprint you want to edit or delete, and then tap **Edit** or **Delete** on the options menu.

Exporting your footprints

You can back up footprints by exporting them to a storage card. You can also open exported footprint files in other applications such as Google Earth on your PC. To transfer files from your storage card to your computer, see “Copying files to and from the storage card” in the Basics chapter.

Press HOME, tap  > Footprints, and then do any of the following:

- To export all your footprints, on the All footprints tab , press MENU and then tap **Export**.
- To export all the footprints from a particular category, while viewing that category, press MENU and then tap **Export**.
- To export a single footprint, open the footprint, press MENU and then tap **Export**.

Exported footprints are saved as .kmz files in the Footprints_Data folder on your storage card. If you exported multiple footprints at one time, they are saved together in one .kmz file.

Importing footprints

You can restore footprints you previously backed up to the storage card. You can also import .kmz files that you saved in other applications, or use a photo as a footprint.

1. Press HOME, and then tap  > Footprints.
2. Press MENU, and then tap **Import**.
3. Do one of the following:
 - To import saved footprints or another .kmz file from the storage card, tap **Footprints data**, and then tap the file you want to import. If a footprint on the device is the same as one you want to import, you are asked whether you want to overwrite it.
 - To import a photo, tap **Picture**, navigate to the photo you want to import, and then tap the photo. You can then add Footprints information such as location and category.

Adding the Footprints widget

Add the Footprints widget to view and access your footprints on the Home screen. To learn how to add widgets, refer to “Adding a widget to your Home screen” in the Personalizing chapter.

More apps

Watching videos on YouTube

YouTube is an online video streaming service that allows you to view videos that have been uploaded by YouTube members.

Press HOME, and then tap  > YouTube. YouTube presents the videos grouped into categories, such as Most viewed, Most discussed, Most recent, and Top rated.





- You do not need a YouTube account to browse and view videos. However, to use all the features of YouTube (such as sharing a video), you must create a YouTube account from your computer and sign in to that account from your phone.
- You must have an active Wi-Fi or data connection to access YouTube.

Watching videos

1. Press HOME, and then tap  > YouTube.
2. On the YouTube screen, scroll through the list of videos, and then tap a video to watch it. The screen automatically switches to landscape view when you play a video.
3. While watching a video, you can:
 - Tap the screen to display the playback controls. When the playback controls are displayed, you can pause, skip forward or backward, or drag the slider to the point in the video you want to watch.
 - Press MENU to rank, comment on, share, flag as inappropriate, and interact with the video in other ways.
4. Press BACK to stop playback, and return to the videos list.

Searching for videos

1. Press HOME, and then tap  > YouTube.
2. On the YouTube screen, press SEARCH.
3. Enter a search keyword, and then tap .
4. The number of search results appears below the status bar. Scroll through the results and tap a video to watch it.

Clearing the search history

1. Press HOME, and then tap  > YouTube.
2. Press MENU and then tap **Settings**.
3. Tap **Clear search history**, and then tap OK when prompted.



Sharing a video link

You can share a video by sending its link to your contacts.

1. Press HOME, and then tap  > YouTube.
2. On the YouTube screen, tap a video to watch from the available categories.
3. While watching a video, press MENU, and then tap **Share**.
4. Select how you want to share the video link.

Capturing a video and sharing it on YouTube

You need to be signed in to your Google Account to upload your video to YouTube.

1. Press HOME, and then tap  > YouTube.
2. Tap .
3. Press the optical trackball to start capturing video. When you are done capturing, press the optical trackball again. Tap **Done**.
4. Enter a title, description, and tags for your video.
5. Set the privacy level.
6. Tap **Upload**.

Viewing a PDF

Use **PDF Viewer** to view PDF files that you have copied to the phone's storage card.

1. Press HOME, and then tap  > **PDF Viewer**.
2. On the Open file screen, tap the file you want to view.
3. Slide your finger on the screen to pan or go through the pages of the PDF. While viewing a PDF, press MENU, and then tap:
 - **Open** to open another PDF file.
 - **Toolbar/Toolbar off** to toggle between showing and hiding the toolbar.
 - **View** to view the PDF in normal view or reformatted view. Choosing **Reformatted** reflows the text and resizes the images to fit the width of the screen, depending on the zoom level.
 - **Zoom** to change the zoom level to either **Fit to screen** or **Fit to width**. This is not available when **Reformatted** is selected for **View**.
 - **Go to** to go to a specific page on the PDF.
 - **More** to search the PDF and view file properties or information about the PDF Viewer.

Turn your phone sideways (turn to the left) to view the PDF file in landscape mode. The screen orientation automatically adjusts depending on how you hold the phone.

Viewing documents, presentations, and spreadsheets

Quickoffice lets you view Microsoft Office Word, Microsoft Office Excel, and Microsoft PowerPoint files on your phone. Quickoffice supports viewing of Microsoft Office 2003 and 2007 Word (.doc), Excel (.xls), PowerPoint (.ppt) and text (.txt) files.



Make sure you have copied the files to the phone's storage card before you open Quickoffice. See "Copying files to and from the storage card" in the Basics chapter to learn how to copy files to the storage card.

1. Press HOME, and then tap  > Quickoffice.
2. On the Open file screen, tap the file you want to open.



In the Open file screen, press MENU and then tap Sort to let you sort the list by Name or Date.

3. Slide your finger on the screen to pan or go through the pages of the file.

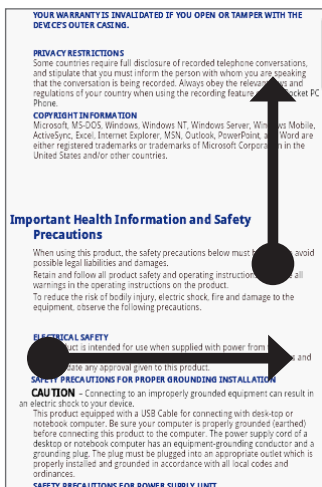

fx	
3	Inside the Box (Reference or Co
4	Your Phone (Topic Head)
5	Front Panel (Add Phone Controls
6	Setting Around Your Phone)
7	Back Panel
8	Left Panel
9	Bottom Panel
10	Top Panel
	Installing the SIM Card, Battery
	Change to "Before Turning On Y
11	Removing the back cover
12	Reinstalling the back cover

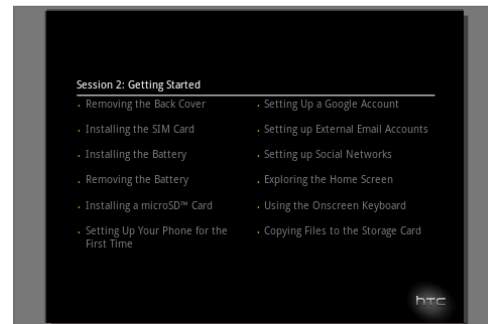

4. While viewing a file, you can:

- Pinch the screen to zoom in or out or use the zoom controls on the screen to zoom in or out.
- For Excel files, press MENU, and then tap **Worksheet** to view other worksheets on the file.
- For Word and PowerPoint files, tap a URL link to open the web page in the web browser.
- When you open Word documents, Quickoffice reformats the text to make it fit the width of the screen. Double-tap the screen to switch to normal view so you can view the page layout.



Quickoffice does not reflow text in tables.

- When you view PowerPoint files, after your zoom in on a slide, you can double-tap the screen to zoom out automatically and fit the slide to the width of the screen.

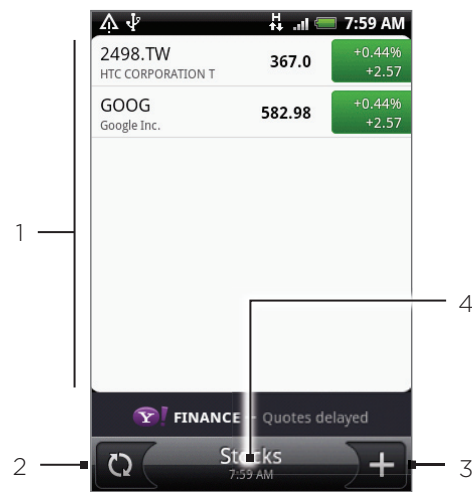

Keeping track of your stocks

Use Stocks to get the latest stock updates for stock quotes and market indices you follow.



- 1 List of your stock quotes and stock market indices. Tap an item to view its intraday chart and other details.
- 2 Tap to update the stock information.
- 3 Tap to add a stock quote or stock market index.
- 4 Shows the time the information was last updated.

Adding a stock quote or stock market index



1. Press HOME, and then tap  > Stocks.
2. On the Stocks screen, tap  at the bottom-right corner of the screen.



If there are no stock quotes or indices onscreen, tap **Tap here to add a stock or index** at the top of the screen.

3. Enter the stock quote or stock market index on the text field, and then tap .
4. On the results list, tap the stock quote or stock market index you want to add.

Changing the stock list order

1. Press HOME, and then tap  > Stocks.
2. Press MENU, and then tap **Rearrange**.
3. Press and hold  at the end of the item you want to move. When the row is highlighted in green, drag it to its new position, and then release.
4. Tap **Done**.

Deleting stock quotes and indices

1. Press HOME, and then tap  > Stocks.
2. Press MENU, and then tap **Delete**.
3. Select the items you want to delete and then tap **Delete**.

Setting stock information update frequency

1. Press HOME, and then tap  > Stocks.
2. Press MENU, and then tap **Settings**.
3. Select the **Auto-sync data** check box.



Downloading stock information automatically may incur additional fees from your mobile operator.

4. Tap **Set download frequency**, and then select frequency to check for updates.

Manually updating stock information

1. Press HOME, and then tap  > Stocks.
2. Press MENU, and then tap **Update**.

Adding the Stocks widget

1. Press HOME, and then tap  > Widget > Stocks.
2. Choose the widget style, and then tap **Select**.
3. Drag the widget to a blank space on the Home screen, and then release.

Listening to the radio

FM Radio lets you listen to FM radio stations on your phone.





You need to connect a headset first to the audio jack of your phone to use FM Radio. FM Radio uses the stereo headset as the FM radio antenna,





- | | |
|----|---|
| 1 | FM radio frequency |
| 2 | Drag to tune in to a frequency on the FM band. |
| 3 | Tap to fine tune the radio frequency by -0.1 MHz. |
| 4 | View the All presets list. |
| 5 | Tap to search the FM band for the previous FM station. |
| 6 | Tap to search the FM band for the next FM station. |
| 7 | Tap to change the name of the current station you are tuned into. |
| 8 | Tap to fine tune the radio frequency by +0.1 MHz. |
| 9 | Radio signal strength |
| 10 | Turn off or on FM radio. |

Listening to an FM station

1. Press HOME, and then tap  > FM Radio.
2. The first time you open FM Radio, it automatically scans for available FM stations, saves them as presets, and plays the first FM station found.
 - To repeat scanning and saving of FM stations, press MENU, and then tap Scan & Save.
 - Press BACK to stop the auto-scan.
3. On the FM Radio screen, you can:
 - Tap  and then select a station you want to listen to.
 - Tap  to go to the previous available FM station, or  to go to the next available FM station.
 - Press the VOLUME UP and VOLUME DOWN buttons on the side of the phone to adjust the volume.
 - Press MENU to set more FM Radio options.

Adding station names

1. Press HOME, and then tap  > FM Radio.
2. Tune in to the desired FM station, and then tap .
3. Enter a station name for the selected FM station, and then tap **Save**.

Minimizing or turning off FM Radio

Do one of the following:

- Press BACK to minimize and keep FM Radio running in the background so you can listen to the radio while going to another screen.
- On the FM Radio screen, tap  on the upper-right corner of the FM Radio screen to turn off FM Radio.





Recording your voice

Voice Recorder is useful for quickly recording thoughts. You can also record your voice and set it as a ringtone.





You need to have a microSD card installed on your phone to use Voice Recorder.

Recording your voice



1. Press HOME, and then tap  > Voice Recorder.
2. Hold the device's microphone near your mouth.
3. Tap  to start recording a voice clip. Tap  to stop recording.
4. Tap  to play back the voice recording.
5. To quickly share the voice recording through Bluetooth, email, or message, tap .

Sharing a voice clip



1. Press HOME, and then tap  > Voice Recorder.
2. On the Voice Recorder screen, tap .
3. On the All recording screen, press and hold the voice recording you want to share, and then tap **Share** on the options menu.
4. On the Share options menu, select how you want to share the voice recording.

To learn how to send files through Bluetooth, see the Bluetooth chapter.

Setting a voice clip as a ringtone

1. Press HOME, and then tap  > Voice Recorder.
2. On the Voice Recorder screen, tap .
3. On the All recording screen, press and hold the voice recording you want to set as a ringtone, and then tap **Set as ringtone** on the options menu.

Renaming a voice clip

1. Press HOME, and then tap  > Voice Recorder.
2. On the Voice Recorder screen, tap .
3. On the All recording screen, press and hold the voice recording you want to rename, and then tap **Rename** on the options menu.
4. Enter the name, and then tap **Save**.

Finding and installing apps from Android Market

Android Market™ is the place to go to find new apps for your phone. Choose from a wide variety of free and paid apps ranging from productivity apps, entertainment, to games. When you find an app you want, you can easily download and install it on your phone with just a few taps of your finger.

To access Android Market, you must first connect to the Internet using your phone's Wi-Fi or data connection and sign in to your Google Account.

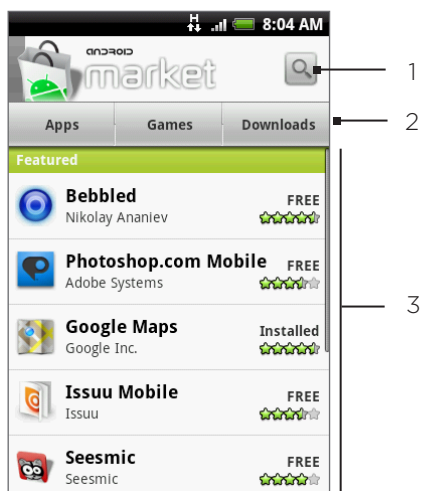

- 1 Tap to search Android Market for apps to install on your phone.
- 2 Tap to display the available apps or games on Android Market, or display the apps that you have already downloaded and installed from Android Market.
- 3 Featured apps list. Tap an app to read a description about the app and user reviews.



Paid apps are currently only available in certain countries.



Finding and installing an application

When you install apps from Android Market and use them on your phone, they may require access to your personal information (such as your location, contact data, and more) or access to certain functions or settings of your phone. Download and install only apps that you trust.

1. Press HOME, and then tap  > Market.
2. When you open Android Market for the first time, the Terms of Service window will appear. Tap **Accept** to continue.
3. To find an app in Android Market, you can:
 - Browse through featured apps. Scroll through the list of featured apps when you open Android Market.
 - Browse apps by categories. First, tap **Apps** or **Games**, and then tap a category. Under a category, you can filter the apps by **Top paid**, **Top free** or **Just in**.



Paid apps are currently only available in certain countries.

- Search for an app. Tap  on the Android Market home screen, enter the name or type of app you're looking for, and then tap  to the right of the search box.
4. Tap an app to read a description about the app and user reviews.
 5. Tap **Install** (for free applications) or **Buy** (for paid applications).



You need a Google Checkout account to purchase items on Android Market. See "Creating a Google Checkout account" to set up a Google Checkout account if you do not have one.

6. The subsequent screen notifies you whether the app will require access to your personal information or access to certain functions or settings of your phone. If you agree to the conditions, tap **OK** to begin downloading and installing the app.

If you selected a paid application, after tapping **OK**, you're redirected to the Google Checkout screen to pay for the application before it's downloaded to your phone.



Read it carefully! Be especially cautious with applications that have access to many functions or a significant amount of your data. Once you tap **OK** on this screen, you are responsible for the results of using this item on your phone.

After installing an app, tap  on the upper-left side of the screen to return to Android Market home. You can also press **MENU**, and then tap **Home**.

Creating a Google Checkout account

You must have a Google Checkout account associated with your Google Account to purchase items from Android Market.

Do one of the following:

- On your computer, go to <http://checkout.google.com> to create a Google Checkout account.
- The first time you use your phone to buy an item from Android Market, you're prompted to enter your billing information to set up a Google Checkout account.



When you've used Google Checkout once to purchase an application from Android Market, the phone remembers your password, so you don't need to enter it the next time. For this reason, you should secure your phone to prevent others from using it without your permission. See the Security chapter to learn how to secure your phone.

Requesting a refund for an application





If you are not satisfied with an application, you can ask for a refund within 24 hours of the purchase. Your credit card is not charged and the application is uninstalled from your phone.

If you change your mind, you can install the application again, but you can't request a refund a second time.

1. Press **HOME**, and then tap  > **Market** > **Downloads**.
2. Tap the application to uninstall for a refund. The details screen for the application opens.
3. Tap **Uninstall & refund**. Your application is uninstalled and the charge is cancelled.
4. Choose the reason for removing the application, and then tap **OK**.

Opening an installed application

Do one of the following:

- On the status bar, check if you see the  icon. If you see the  icon, open the Notifications Panel, and then tap the app to open it. See “Opening the Notifications panel” in the Basics chapter to learn how to open the Notifications Panel.
- Press HOME, and then tap  > Market > Downloads. On the Download screen, tap the app to open it.
- Press HOME, and then tap . On the All programs screen, locate the app, and then tap it.

Uninstalling an application

You can uninstall any application that you have downloaded and installed from Android Market.

1. Press HOME, and then tap  > Market > Downloads.
2. On the Downloads screen, tap the application you want to uninstall, and then tap **Uninstall**.
3. When prompted, tap **OK** to remove the application on your phone.
4. Choose the reason for removing the application, and then tap **OK**.

Getting help

If you ever need help or have questions about Android Market, press MENU, and then tap **Help**. The web browser will take you to the Android Market Help web page.

Reading news feeds

Use **News** to subscribe to news feeds to keep up with the latest buzz on the Internet. News monitors RSS feeds from your favorite news sites, blogs and more, and downloads the most current updates.

News screen



-
- 1 **Subscriptions tab**
Displays the channels that you are subscribed to. Tap a channel to show the stories for that particular channel.

 - 2 **Starred tab**
Displays channels and the number of stories (enclosed in parenthesis) that have been starred. Tap a channel to show the starred stories for that channel, then tap a story to read it.

 - 3 **Keywords tab**
Displays the keywords that you have created and the number of stories (enclosed in parenthesis) that match them. Tap a keyword to display the stories that contain the particular keyword.
-

Subscribing to a news channel from a list

1. Press HOME, and then tap  > News.
2. On the Subscriptions tab, tap Add feeds.
3. Tap one of the categories on the screen to open the available channels.
 - Tap Search news feed to search the Web for other channels.
 - Tap Add Google news feed to subscribe to a channel from Google News.
4. Select the channel(s) you want to subscribe to.
5. Repeat steps 3 to 4 to subscribe to more channels.
6. Tap Done.

Subscribing to a news channel by entering a URL

1. Press HOME, and then tap  > News.
2. On the **Subscriptions** tab, tap **Add feeds > Add from URL**.
3. Enter the complete URL for the RSS feed, and then tap **Done**.

Setting update frequency for stories







Set News to automatically check for updates for the channels that you are subscribed to.

1. Press HOME, and then tap  > News.
2. While on the **Subscription** tab, press MENU, and then tap **More > Settings > Check frequency**.
3. Tap the time you want.





To manually check for updates, on the **Subscription** tab, press MENU, and then tap **Refresh**.

Reading a story

1. Press HOME, and then tap  > News.
2. On the **Subscriptions** tab, tap a channel whose stories you want to read.
3. Scroll through the list of stories, and then tap a story to read it.
4. While reading a story, you can tap:
 -  and  to go to the previous or next story in the channel.
 -  to go back to the stories list.
 -  to share the story via a message (link to the story only) or email.
 -  to delete the story from the stories list.
5. If you want to read the whole story, tap **Read full article**. This opens the story in the web browser. See “Using your phone’s web browser” in the Internet chapter to learn how to navigate the web page.

Starring a story

Star your favorite stories to make it easy to come back to them.

1. Press HOME, and then tap  > News.
2. On the **Subscriptions** tab, tap the channel where the story you want to star is located.
3. Do one of the following:
 - Locate the story, and then tap .
 - Tap the story you want to star to open it, and then tap  near the top-right corner of the screen.

You can remove the star from an story by tapping .

Adding a keyword

Find stories the interest you easier by creating keywords. Stories that contain the keyword are grouped together making it easier to find the story you want.

1. Press HOME, and then tap  > News.
2. On the **Keywords** tab, tap **Add keywords**.
3. Enter the keyword, and then tap **Done**.
4. In the **Keywords** tab, tap a keyword to show the stories that contain the keyword in their text.

Adding the News widget

Read snippets of stories that you have subscribed to right on the Home screen.

1. Press HOME, and then tap  > Widget > News.
2. Choose the widget style, and then tap **Select**.
3. Select the channel whose stories you want to read on the widget.
4. Drag the widget to a blank space on the Home screen, and then release.

Security

Protecting your SIM card with a PIN

You can protect your SIM card from unauthorized use by assigning a PIN (personal identification number).



The default SIM PIN is provided by your mobile operator.

1. Press HOME > MENU, then tap **Settings**.
2. Scroll down the screen, tap **Security > Set up SIM card lock**, and then select the **Lock SIM card** check box.
3. Enter the default SIM card PIN, and then tap **OK**. To change the SIM card PIN, tap **Change SIM PIN**.



Emergency calls can be placed at any time, without requiring a PIN. See “Making an emergency call” in the Phone calls chapter for more details.

Restoring a SIM card that has been locked out

If you enter the wrong PIN more times than the maximum number of attempts allowed, your SIM card will become “PUK-locked.” You need a PUK code to restore access to the phone. This code may have been provided by your mobile operator when you received your SIM card.

1. On the phone dialer screen, enter the PUK code, and then tap **Next**.
2. Enter the new PIN you want to use, and then tap **Next**.
3. Enter the new PIN again, and then tap **Next**.

Protecting your phone with a screen lock

You can further secure your phone by requiring a screen unlock pattern every time your phone is turned on or every time it wakes up from sleep mode (screen is off).

1. Press HOME > MENU, and then tap **Settings**.
2. Scroll down the screen, and then tap **Security > Set unlock pattern**.
3. Read the information on the screen, and then tap **Next**.
4. Study the example pattern on the screen, and then tap **Next**.
5. Draw the screen unlock pattern by connecting at least four dots in a vertical, horizontal and/or diagonal direction. Lift your finger from the screen when finished.



You must slide your finger on the screen to create the pattern and not tap individual dots.

6. The phone records the pattern. Tap **Continue**.
7. When prompted, draw the screen unlock pattern again, and then tap **Confirm**.



Clear the **Use visible pattern** check box if you do not want the unlock pattern to display on the screen when you unlock it.

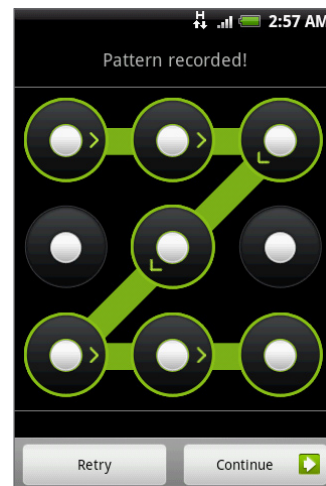

To change your unlock screen pattern, press HOME > MENU, and then tap **Settings > Security > Change unlock pattern**.

When you fail to draw the correct unlock screen pattern on the screen after five attempts, you will be prompted to wait for 30 seconds before you can try again. If you forgot your screen unlock pattern, tap **Forgot pattern**. You will be prompted to sign in using your Google Account name and password, and create a new screen unlock pattern before the Home screen displays.



You need to be connected to a data or Wi-Fi connection to be able to sign in to your Google Account.

Settings

Settings on your phone

Control and customize phone settings on the Settings screen.

To open the Settings screen, press HOME > MENU, and then tap **Settings**.

Personalize

Select a scene, set the Home screen or Lock screen wallpaper to use, and set the default ring tone to use for incoming calls. You can also rename or delete a custom scene by pressing and holding a custom scene in Scenes.

Wireless & networks

Configure your phone's wireless connections, such as Wi-Fi and Bluetooth, enable the Airplane mode, or set the options for mobile networks, roaming, Virtual Private Networks, and more.

Call

Set up call services such as voice mail, call forwarding, call waiting, and caller ID.

Sound & display

Set the phone and notification ring tones, automatic screen orientation, and set the screen brightness and screen timeout.

Accounts & sync

Log in or out from your social network accounts, Google Account, and Exchange ActiveSync account. You can also manage synchronization and other settings for your accounts. See the Accounts and sync chapter for details.

Location

Select the sources to use when determining your location.

Search

Select items to include when you do a search on your phone and set Google search options.

Privacy

Select whether to allow or block Google from using your location when suggesting results and for other Google services. You can also enable or disable the automatic backup feature of the phone and reset the phone. See the Backup, Update and Reset chapter for more details.

Connect to PC

Set the default USB connection type when you connect your phone to your computer. Select **Ask me** to always display the connection type dialog box when the device is connected. See "Connecting your phone to a computer" in the Basics chapter for details.

Security

Set the screen unlock pattern, enable the SIM card lock, or manage the phone's credential storage. See the Security chapter for details.

Applications

Manage applications and installation of new programs.

SD card & phone storage

Check the available storage card and phone memory.

Date & time

Set the date and time, time zone, and date or time format. To turn off auto time synchronization and be able to manually change time zone settings, see “Changing time zone settings” in the Clock and Weather chapter.

Language & keyboard

Set the operating system language and region. You can also set onscreen keyboard options.

Accessibility

Enable or disable preset or downloaded accessibility plugins that respond to user interaction such as receiving sound feedback when a new browser window is opened.

Text-to-speech

If you have installed a text-to-speech (voice data) application, use this option to configure the text-to-speech settings.

About phone

Set the system software update method and view the phone status such as the network type, signal strength, battery power level, and network name. You can also check the battery use of individual applications or view the legal information and software version of your phone. See “Checking information about your phone” in this chapter for details.

Changing display settings

Adjusting the screen brightness manually

1. Press HOME > MENU, and then tap **Settings > Sound & display**.
2. Scroll down the screen, and then tap **Brightness**.
3. Clear the **Automatic brightness** check box.
4. Drag the brightness slider to the left to decrease or to the right to increase the screen brightness. Tap **OK**.

Adjusting the time before the screen turns off

After a period of inactivity, the phone screen turns off to conserve battery power. You can set the idle time before the screen turns off.

1. Press HOME > MENU, then tap **Settings > Sound & display**.
2. Scroll down the screen, and then tap **Screen timeout**.
3. Tap the time before the screen turns off.



To quickly turn off the screen, press the **POWER** button.

Preventing automatic screen rotation

By default, the screen orientation automatically adjusts depending on how you hold the phone.



Not all application screens support automatic rotation.

1. Press HOME > MENU, then tap **Settings > Sound & display**.
2. Scroll down the screen, and then clear the **Orientation** check box.

Recalibrating the G-sensor

Recalibrate the screen if you feel that the screen orientation does not respond properly to the way you hold the phone.

1. Press HOME > MENU, then tap **Settings > Sound & display**.
2. Scroll down the screen, and then tap **G-Sensor calibration**.
3. Place the phone on a flat and level surface, and then tap **Calibrate**.
4. After the recalibration process, tap **OK**.

Keeping the screen on while charging the phone

You can keep the phone screen from turning off while you are charging the phone.

1. Press HOME > MENU, then tap **Settings**.
2. Scroll down the screen, and then tap **Applications > Development**.
3. Select the **Stay awake** check box.

Switching animation effects on or off

You can turn off the animation or enable only some animations when switching between screens.

1. Press HOME > MENU, and then tap **Settings > Sound & display**.
2. Scroll down the screen, and then tap **Animation**.
3. On the options menu, select the animation setting you want.

Changing sound settings

Setting a sound profile

Switch to vibrate or silent mode, or use the normal phone sound settings.

1. Press HOME > MENU, and then tap **Settings > Sound & display > Sound Profile**.
2. In the Choose a Profile options menu, tap the sound profile you want to use.

Enabling or disabling touch tones

You can choose to play a sound when you are selecting items onscreen.

1. Press HOME > MENU, and then tap **Settings > Sound & display**.
2. Scroll down the screen, and then select or clear the **Audible selection** check box.

Choosing the notification sound

You can select the sound to play when your phone receives new notifications.

1. Press HOME > MENU, and then tap **Settings > Sound & display > Notification sound**.
2. Select your preferred notification sound in the list, and then tap **OK**.

Changing the phone language

When you turn your phone on for the first time, you are prompted to select the language you would like to use. You can also change the language on the fly whenever you like. Changing the language adjusts the keyboard layout, date and time formatting, and more.

The languages available to choose from may depend on the version of phone you have.

1. Press HOME > MENU, and then tap **Settings > Language & keyboard > Select locale**.
2. Tap the language and corresponding region you want to use.
3. Press HOME to return to the Home screen. You may need to wait briefly as the new language is applied to your phone.

Optimizing your phone's battery life

When you're on the go, it's not always easy to charge your phone's battery as often as you'd like. Follow these tips to extend the time between charges:

- Turn off wireless functions such as Bluetooth, Wi-Fi, and data connection when you're not using them. See the Internet and Bluetooth chapters for details.
- Use only GSM networks. See "Using the GSM network of your mobile operator" in this chapter for details
- Do not use GPS satellites to determine your GPS location. See the Maps & Location chapter for details.
- Lower the screen brightness. See "Adjusting the screen brightness manually" in this chapter for details.
- Switch off screen animations. See "Switching animation effects on or off" in this chapter for details
- Cut down on activities such as Internet browsing. Wireless data consumes a lot of power.
- Avoid making very long phone calls or using the camera for extended periods of time.
- Consider carrying a spare battery for times when you can't charge your battery for an extended period.
- Batteries gradually lose storage capacity over time. Consider replacing your battery after eight months to a year, or if you notice that the battery life is decreasing.

Using the GSM network of your mobile operator

Switch to using the GSM network of your mobile operator if you are not using a data connection to connect to the Internet. Connecting to your mobile operator's GSM network consumes less battery power.

1. Press HOME > MENU, and then tap **Settings > Wireless & networks**.
2. Scroll down the screen, and then tap **Mobile networks > Network mode**.
3. Tap **GSM only**.

Checking the power usage of applications

1. Press HOME > MENU, and then tap **Settings**.
2. Scroll down the screen, and then tap **About phone > Battery > Battery use**.

Managing memory

Checking how much phone memory is available for use

1. Press HOME > MENU, and then tap **Settings**.
2. Scroll down the screen, and then tap **SD card & phone storage**. The available phone memory is displayed in the Internal phone storage section.

Checking the available storage card space

1. Press HOME > MENU, and then tap **Settings**.
2. Scroll down the screen, and then tap **SD card & phone storage**. The total and available storage card space is displayed in the **SD card** section.

Clearing application cache and data

1. Press HOME > MENU, and then tap **Settings**.
2. Scroll down the screen, and then tap **Applications > Manage applications**.
3. On the Manage applications screen, tap the application whose cache and/or data you want to delete.



Press MENU to bring up sort and filter options.

4. In the Application info screen, tap **Clear data** and/or **Clear cache**.

Uninstalling third-party applications

You cannot uninstall applications that are preinstalled on the phone.

1. Press HOME > MENU, and then tap **Settings**.
2. Scroll down the screen, and then tap **Applications > Manage applications**.
3. Press MENU, and then tap **Filter > Downloaded**.
4. On the Manage applications screen, tap the application you want to uninstall.
5. On the Application info screen, tap **Uninstall**.

Freeing up more phone memory or storage card space

If your phone is running low on memory, try the following:

- In your web browser, clear all temporary Internet files and history information. See the Internet chapter for more information.
- Uninstall downloaded programs from Android Market you no longer use. See “Finding and Installing Apps from Android Market “ in the More apps chapter for details.

Checking information about your phone

1. Press HOME > MENU, and then tap **Settings**.
2. Scroll down the screen, and then tap **About phone**.
3. Select one of the following:

System software updates

Enable or disable the automatic check feature for software updates for your phone. You can also tap **Check now** to manually check for software updates.

Network

Check information about your mobile operator and its service status.

Phone identity

Check information about your phone and the SIM card you are using.

Battery

Check information about the battery such as its current battery level, status, and what programs are using the battery.

Hardware information

Check the Wi-Fi MAC and Bluetooth addresses.

Software information

Check the version and other information about the Android platform being used by the phone. You can also check the version of the web browser.

Legal information

Read legal information from HTC and Google, and licenses used by the phone.

Learn more

Provides the link to the HTC website so you can learn more about your phone.

Backup, update and reset

Backing up phone data

Your phone features an automatic backup system that backs up your web browser bookmarks, messages, dictionary, and settings, to the microSD card. The phone automatically backs up the data whenever a change occurs.

The phone backs up the following data:

- SMS and MMS messages
- Messages application settings
- Web browser (the Internet application) bookmarks
- Keyboard dictionary
- Settings
 - Wireless & networks
 - Sound & display
 - Location
 - Applications
 - Date & time
 - Language & keyboard - Only Locale setting



You need a microSD card installed on your phone to back up phone data. See “Inserting the storage card” in the Basics chapter to learn how to install a microSD card to your phone.

Checking if automatic backup is enabled

1. Press HOME > MENU, and then tap **Settings**.
2. Scroll down the screen, and then tap **Privacy > Back up my data**.
3. Make sure that the **Back up my data** check box is selected.

Restoring backed up data to your phone

After you do a factory reset or update your phone, you will be asked if you want to restore the backed up data after you turn on your phone.



Make sure that the microSD card where you backed up the data is installed on the phone.

1. After you do a factory reset or update your phone system software, wait for the phone to restart.
2. When there is a valid back up file in the microSD card, the Restore my data and settings dialog box will appear. When you see this dialog box, tap **OK**.

Updating your phone's system software

From time to time, system software updates for your phone may be available. Your phone can check and then notify you if an update is available. You can then download and install the update to your phone.

Depending on the type of update, the update may erase all your personal data and customized settings, and also remove any programs you have installed. Make sure that you have backed up the information and files you want to keep. See “Backing up phone data” in this chapter for details.



Checking and downloading system software updates may incur additional data transfer fees from your mobile operator.

1. When there is an update available, the Install system software update dialog box will appear onscreen.
2. On the dialog box, select **Install now**, and then tap **OK**.



Select **Install later** if you want to install the system update at a later time. When you are ready to install, open the Notifications panel, and then tap **System update is ready**.

3. Wait for the update process to finish. When the update is finished, the phone will automatically reset.

Checking for phone system software updates manually

1. Press **HOME > MENU**, then tap **Settings**.
2. Scroll down the screen, and then tap **About phone > System software updates**.
3. On the System software update screen, tap **Check now**.

Performing a hard/factory reset

You can return your phone to its original state, as it was when it left the factory. This is also called a hard reset. You might want to do this if you are giving your phone to a friend or relative and you want to remove all your data first, or if your phone has a persistent problem that is not solved by powering off the phone and then powering it on again.

A factory reset is a drastic measure. It permanently erases all your personal data and customized settings, and also removes any programs you have installed. Make sure that you have backed up the information and files you want to keep.



If your phone hangs or freezes, we recommend that you do a “soft” reset instead of a hard/factory reset. To perform a soft reset, remove the battery, wait for a few seconds, and then re-install it. After re-installing the battery, turn on the phone.

Performing a factory reset via settings

The most convenient way to do a factory reset is via the phone settings.

1. Press HOME > MENU, then tap **Settings**.
2. Scroll down the screen, and then tap **Privacy > Factory data reset**.
3. On the Factory data reset screen, tap **Reset phone**, and then tap **Erase everything**.

Performing a factory reset using phone buttons

If you cannot turn on your phone or access the phone settings, you can still perform a factory reset by using the buttons on the phone.

1. With the phone turned off, press and hold the VOLUME DOWN button, and then briefly press the POWER button.
2. Wait for the screen with the 3 Android images to appear, and then release the VOLUME DOWN button.
3. Press VOLUME DOWN to select **CLEAR STORAGE**, and then press POWER.
4. When asked to confirm, press VOLUME UP.

Specifications

CPU speed	600 MHz
Platform	Android™ 2.1 (Éclair) with HTC Sense™
Memory	ROM: 512 MB RAM: 384 MB
Dimensions (LxWxT)	112 x 56.3 x 11.5 mm (4.41 x 2.22 x 0.45 inches)
Weight	126 grams (4.44 ounces) with battery
Display	3.2-inch AMOLED touch-sensitive screen with 320 X 480 HVGA resolution
Network	HSPA/WCDMA: <ul style="list-style-type: none">▪ Canada: 850/1900 MHz▪ Upload speed of up to 5.76 Mbps and download speed of up to 7.2 Mbps Quad-band GSM/GPRS/EDGE: <ul style="list-style-type: none">▪ 850/900/1800/1900 MHz (Band frequency, HSPA availability, and data speed are operator dependent.)
Onscreen navigation	Optical trackball
GPS	Internal GPS antenna
Sensors	G-Sensor Digital compass Proximity sensor Ambient light sensor
Connectivity	<ul style="list-style-type: none">▪ Bluetooth® 2.1 with FTP/OPP for file transfer, A2DP for wireless stereo headsets, and PBAP for phonebook access from the car kit▪ Wi-Fi®: IEEE 802.11 b/g▪ 3.5 mm stereo audio jack▪ Standard micro-USB (5-pin micro-USB 2.0)
Camera	5 megapixel color camera with auto focus and flash
Audio supported formats	<ul style="list-style-type: none">▪ Playback: .aac, .amr, .ogg, .m4a, .mid, .mp3, .wav, .wma▪ Recording: .amr
Video supported formats	<ul style="list-style-type: none">▪ Playback: .3gp, .3g2, .mp4, .wmv▪ Recording: .3gp
Battery	<ul style="list-style-type: none">▪ Rechargeable Lithium-ion polymer or Lithium-ion battery▪ Capacity: 1300 mAh▪ Talk time: Up to 440 minutes for WCDMA Up to 490 minutes for GSM▪ Standby time: Up to 560 hours for WCDMA Up to 440 hours for GSM (The above are subject to network and phone usage.)
Expansion slot	microSD™ memory card (SD 2.0 compatible)
AC adapter	Voltage range/frequency: 100 ~ 240V AC, 50/60 Hz DC output: 5V and 1A
Special features	Friend Stream



Specifications are subject to change without prior notice.

Index

Symbols

3G 128

A

Access point 128
Adding a city to the Weather screen 126
Adding a city to the World Clock screen 123
Adding a new contact 56
Adding application icons and other shortcuts on your Home screen 40
Adding a widget to your Home screen 39
Adding folders on your Home screen 41
Adjusting the volume 32
Airplane Mode 53
Alarm clock 124
Album (Photos application) 156
Android Market 188
Answering an incoming call 46
Audio supported formats 208

B

Backing up phone data 205

- automatic backup 205

Backing up your contacts to the storage card 58
Battery times 208
Bluetooth 142

- connecting headset or car kit 143
- sending and receiving information 145
- sending photos or videos 161

Bookmarks 139
Browser 134

C

Calendar application 110
Calendar widget 118
Call history 50
Call services 52
Camera 148
Capturing video 152
Changing your wallpaper 38
Checking information about your phone 204
Checking weather 126
Clock 119
Clock widget (HTC) 119
Conference call 49
Connecting your phone to a computer 33

Copying files to and from the storage card 34
Creating a calendar event 110
Creating a playlist 165
Cropping a photo 160
Customizing and saving a scene 37

D

Data connection 128
Date and time 122
Deleting a scene 37
Deleting contacts 59
Desk Clock 121
Downloading HTC widgets 39

E

Editing a contact's information 58
Email 98

- adding a POP3/IMAP account 105
- deleting 100, 106
- sending 101, 108
- sending photos or videos 161
- settings 103, 109

Ending a call 49
Event reminders 115
Exchange ActiveSync 79
Extended Home screen 27

F

Facebook 86

- Facebook widget 87
- sharing photos 162

Factory reset 207
Finger gestures 23
Flash (camera) 151
Flickr 162
FM Radio 185
Folders 41
Footprints 176
Friend Stream 91

- Friend Stream widget 92

G

Gmail/Google Mail 98
Google Accounts 78
Google Maps 168
Google News 191
GPS satellites 168

H

Hard reset 207
 Home city 122
 Home page 134
 Home screen 27
 Home screen wallpaper 38
 HTC Clock widget 119
 HTC Sync 81

I

Importing contacts from online directories 57
 Importing contacts from the storage card 58
 Importing contacts from your SIM card 57
 Internet 128
 Inviting guests to your event (Google Account only) 111

K

Keyboard 64

L

Library (Music) 164
 Listening to the radio 185
 Location sources 168
 Lock screen wallpaper 38

M

Mail 105
 Making an emergency call 45
 Making Calls 43
 Managing memory 203
 Maps 168
 Meeting request 107, 111
 Memory 208
 Merging contact information 57
 Messages 69
 Microsoft Exchange ActiveSync 79
 Missed call 51
 MMS 69
 Mobile network connection 128
 Music application 163
 Music widget 167
 Mute the microphone 49

N

News 191
 News feeds 191
 Notification icons 29
 Notification ring tone 200
 Notifications panel 31

O

Onscreen keyboard 64
 Optimizing your phone's battery life 202

P

PDF Viewer 181
 Peep 88
 - widget 90
 People 54
 - contact groups 60
 - contact information and conversations 62
 - People screen 55
 - People widget 63
 Personalizing 36
 Phone status icons 28
 Photo capture 151
 Photos application 156
 Picasa 162
 Picture message 69
 Playing music 163
 Playlist 165
 Protecting your phone with a screen lock 195
 Protecting your SIM card with a PIN 194
 PUK 194
 Putting a call on hold 49

Q

Quickoffice 182
 Quick Search Box 35

R

Reading news feeds 191
 Rearranging or removing widgets and icons on your Home screen 42
 Recalibrating the G-sensor 198
 Recording your voice 187
 Rejecting a call and sending a text message 47
 Rejecting an incoming call 47
 Renaming a scene 37
 Review screen (Camera) 149
 Ringtone 167
 Rotating and saving a photo 160

S

Scenes 37
 Search 35
 Searching for a contact 58
 Searching your phone and the Web 35
 Sending a meeting request using Calendar (Exchange ActiveSync only) 111

Sending a photo or video by MMS 161
 Sending a vCalendar 118
 Sending contact information 59
 Sending music using Bluetooth 167
 Sending photos or videos by email 161
 Sending photos or videos using Bluetooth 161
 Setting a song as ringtone 167
 Settings 196

- alarm sound 125
- calendar 117
- camera 153
- display settings 198
- phone language 201
- sound settings 200
- weather 127

 Setting the time zone, date, and time 122
 Setting up My contact card 55
 Setting up your phone for the first time 24
 Setting your home city 122
 Sharing photos on Facebook 162
 Sharing photos on Flickr 162
 Sharing photos on Picasa 162
 Sharing videos on YouTube 162
 Shortcuts 40
 Sleep mode 26
 SMS 69
 Social network accounts 78
 Speakerphone 49
 Specifications 208
 Speed dial 44
 Stocks 183
 Stopwatch 120
 Sync with computer 81
 Sync with online accounts 78

T

Taking a photo 151
 Tethering 141
 Text message 69
 Timer 120
 Time zone 122
 Turning off your phone 24
 Turning on your phone 24
 Twitter 88
 Twittering on your phone 88

U

Uninstalling third-party applications 203
 Updating your phone's system software 206
 Using your phone as a modem 141

V

vCalendar 118
 Video capture 152
 Videos 179
 Video supported formats 208
 Viewfinder screen (Camera) 148
 Viewing a PDF 181
 Viewing photos and videos 157
 Viewing photos on Facebook 159
 Viewing photos on Flickr 159
 Voice Recorder 187
 VPN 132

W

Wallpaper 38
 WAP push messages 73
 Watching video (Photos application) 158
 Weather 126
 Weather widget 127
 Web browser 134
 Wi-Fi 129
 Widgets 39, 42
 World Clock 122

Y

Your phone 14

- charging the battery 22
- closing the battery compartment door 19
- inserting the battery 21
- inserting the SIM card 20
- inserting the storage card 20
- opening the battery compartment door 19
- removing the battery 22
- removing the bottom cover 18
- removing the SIM card 20
- removing the storage card 21
- replacing the bottom cover 18

 YouTube 162, 179

Z

Zooming (camera) 150
 Zooming in or out on a photo 158